

Low Noise Transistors

NPN Silicon

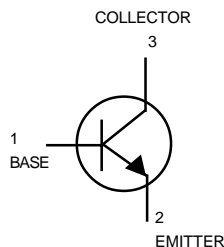

MMBT5088LT1
MMBT5089LT1

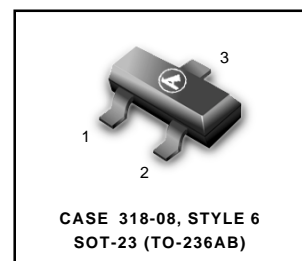

MAXIMUM RATINGS

Rating	Symbol	5088LT	15089LT1	Unit
Collector–Emitter Voltage	V_{CEO}	30	25	Vdc
Collector–Base Voltage	V_{CBO}	35	30	Vdc
Emitter–Base Voltage	V_{EBO}	4.5		Vdc
Collector Current—Continuous	I_C	50		mAdc

THERMAL CHARACTERISTICS

Characteristic	Symbol	Max	Unit
Total Device Dissipation FR-5 Board (1) $T_A=25^\circ\text{C}$ Derate above 25°C	P_D	225	mW
Thermal Resistance, Junction to Ambient	$R_{\theta JA}$	556	$^\circ\text{C/W}$
Total Device Dissipation Alumina Substrate, (2) $T_A=25^\circ\text{C}$ Derate above 25°C	P_D	300	mW
Thermal Resistance, Junction to Ambient	$R_{\theta JA}$	417	$^\circ\text{C/W}$
Junction and Storage Temperature	T_J, T_{stg}	-55 to +150	$^\circ\text{C}$

DEVICE MARKING

MMBT5088LT1 = 1Q; MMBT5089LT1 = 1R

ELECTRICAL CHARACTERISTICS ($T_A = 25^\circ\text{C}$ unless otherwise noted)

Characteristic	Symbol	Min	Max	Unit
OFF CHARACTERISTICS				
Collector–Emitter Breakdown Voltage ($I_C = 1.0\text{ mAdc}, I_B = 0$)	$V_{(BR)CEO}$			Vdc
MMBT5088		30	—	
MMBT5089		25	—	
Collector–Base Breakdown Voltage ($I_C = 100\ \mu\text{Adc}, I_E = 0$)	$V_{(BR)CBO}$			Vdc
MMBT5088		35	—	
MMBT5089		30	—	
Collector Cutoff Current ($V_{CB} = 20\text{ Vdc}, I_E = 0$) ($V_{CB} = 15\text{ Vdc}, I_E = 0$)	I_{CBO}			nAdc
MMBT5088		—	50	
MMBT5089		—	50	
Emitter Cutoff Current ($V_{EB(off)} = 3.0\text{ Vdc}, I_C = 0$) ($V_{EB(off)} = 4.5\text{ Vdc}, I_C = 0$)	I_{EBO}			nAdc
MMBT5088		—	50	
MMBT5089		—	100	

1. FR-5 = 1.0 x 0.75 x 0.062 in.

2. Alumina = 0.4 x 0.3 x 0.024 in. 99.5% alumina.

MMBT5088LT1 PNP MMBT5089LT1

ELECTRICAL CHARACTERISTICS ($T_A = 25^\circ\text{C}$ unless otherwise noted) (Continued)

Characteristic	Symbol	Min	Max	Unit
DC CHARACTERISTICS				
DC Current Gain ($I_C=100\mu\text{A}$, $V_{CE}=5.0\text{Vdc}$)	h_{FE}	300	900	—
		MMBT5088	400	
($I_C=1.0\text{mA}$, $V_{CE}=5.0\text{Vdc}$)	h_{FE}	350	—	—
		MMBT5089	450	
($I_C=10\text{mA}$, $V_{CE}=5.0\text{Vdc}$)	h_{FE}	300	—	—
		MMBT5089	400	
Collector–Emitter Saturation Voltage ($I_C=10\text{mA}$, $I_B=1.0\text{mA}$)	$V_{CE(sat)}$	—	0.5	Vdc
Base–Emitter Saturation Voltage ($I_C=10\text{mA}$, $I_B=1.0\text{mA}$)	$V_{BE(sat)}$	—	0.8	Vdc
SMALL-SIGNAL CHARACTERISTICS				
Current–Gain — Bandwidth Product ($I_C=500\mu\text{A}$, $V_{CE}=5.0\text{Vdc}$, $f=20\text{MHz}$)	f_T	50	—	MHz
Collector–Base Capacitance ($V_{CB}=5.0\text{Vdc}$, $I_E=0$, $f=1.0\text{MHz}$ emitter guarded)	C_{cb}	—	4.0	pF
Emitter–Base Capacitance ($V_{EB}=0.5\text{Vdc}$, $I_C=0$, $f=1.0\text{MHz}$ collector guarded)	C_{eb}	—	10	pF
Small Signal Current Gain ($I_C=1.0\text{mA}$, $V_{CE}=5.0\text{Vdc}$, $f=1.0\text{kHz}$)	h_{fe}	350	1400	—
		MMBT5089	450	
Noise Figure ($I_C=100\mu\text{A}$, $V_{CE}=5.0\text{Vdc}$, $R_S=10\text{k}\Omega$, $f=1.0\text{kHz}$)	NF	—	3.0	dB
		—	2.0	

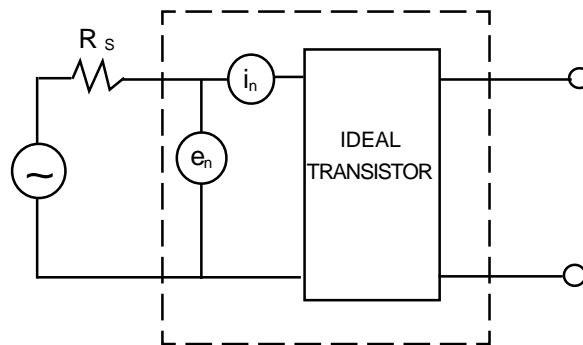

Figure 1. Transistor Noise Model

MMBT5088LT1 MMBT5089LT1

NOISE CHARACTERISTICS

($V_{CE} = 5.0 \text{ Vdc}$, $T_A = 25^\circ\text{C}$)

NOISE VOLTAGE

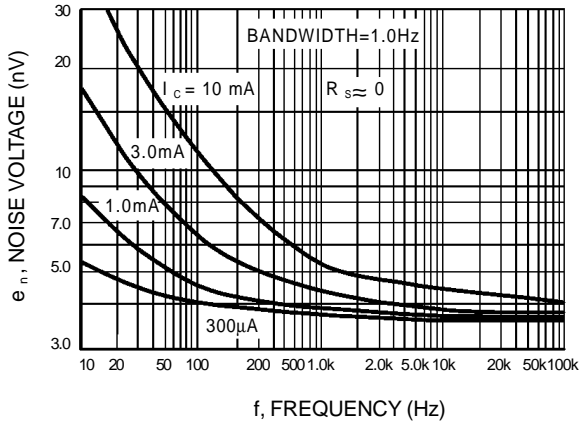

Figure 2. Effects of Frequency

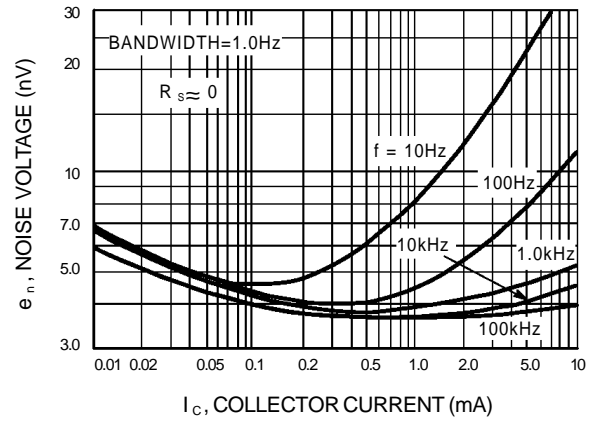

Figure 3. Effects of Collector Current

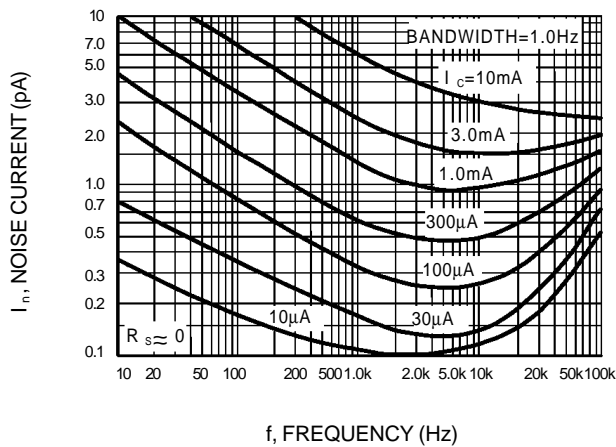

Figure 4. Noise Current

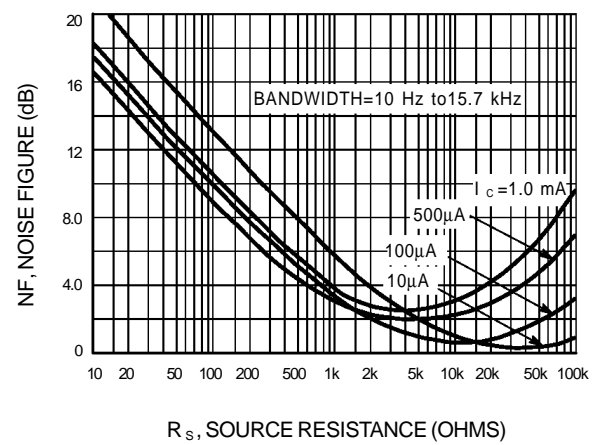

Figure 5. Wideband Noise Figure

100 Hz NOISE DATA

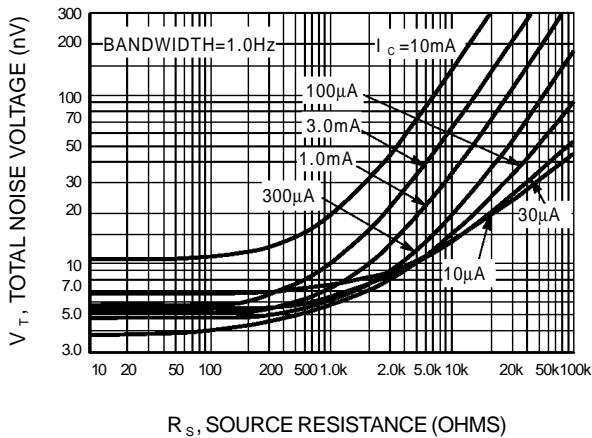

Figure 6. Total Noise Voltage

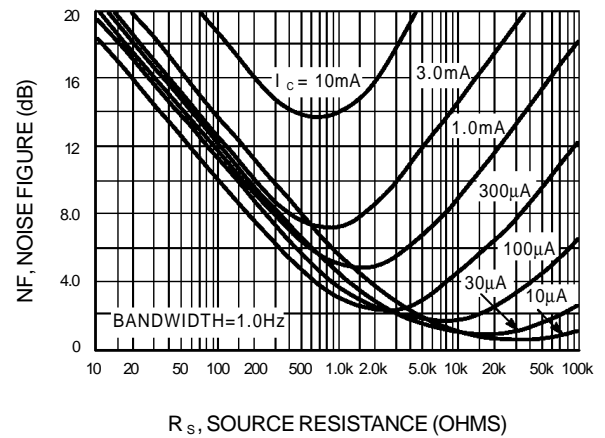

Figure 7. Noise Figure

MMBT5088LT1 MMBT5089LT1

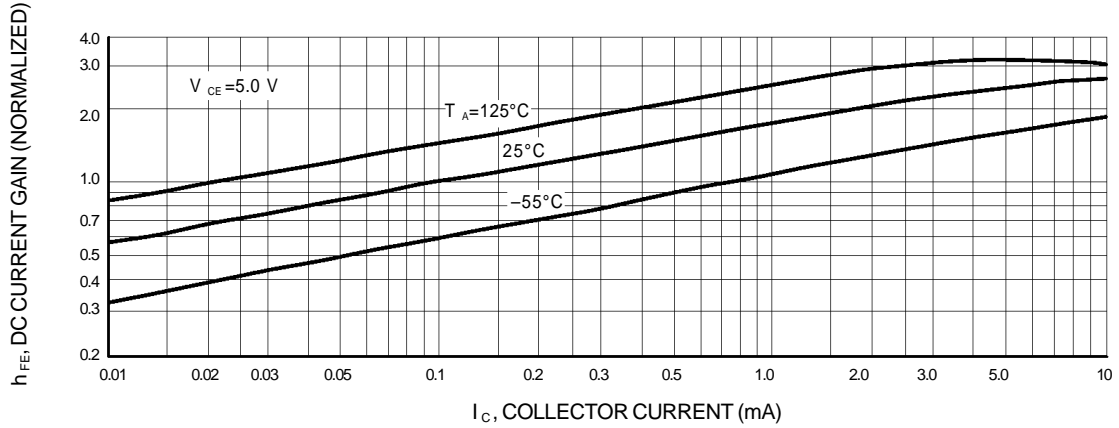

Figure 8. DC Current Gain

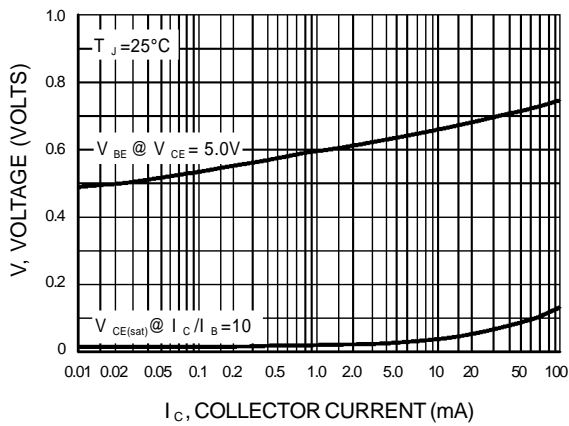

Figure 9. "On" Voltages

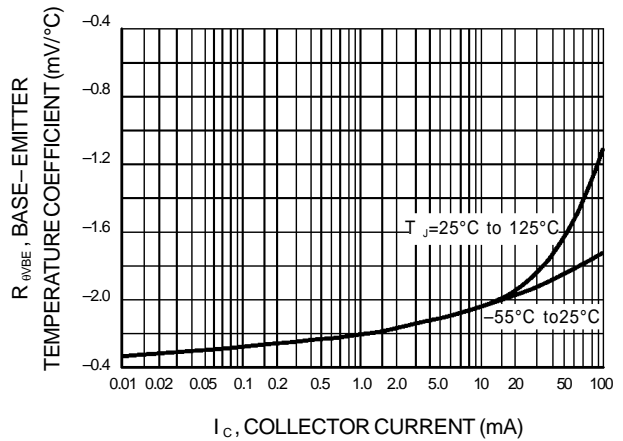

Figure 10. Temperature Coefficients

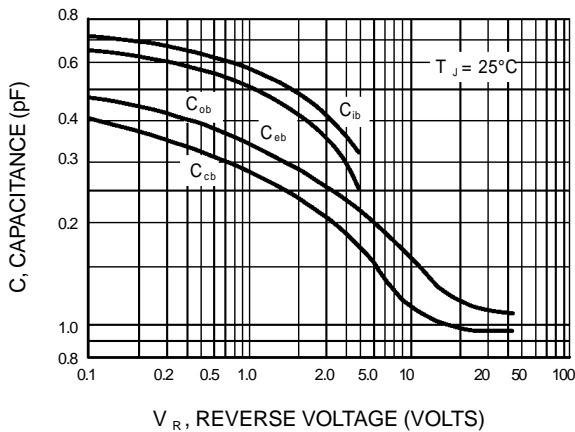

Figure 11. Capacitance

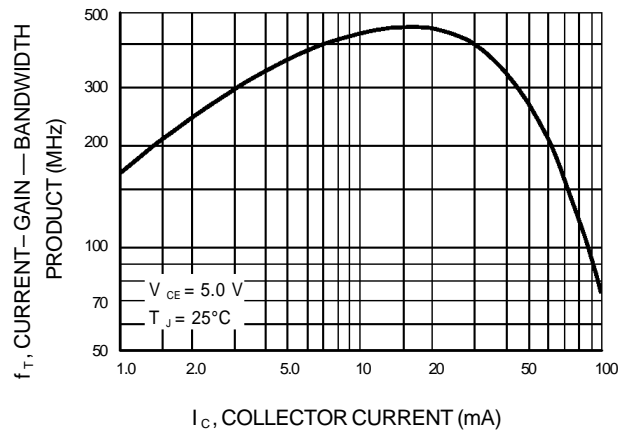

Figure 12. Current-Gain — Bandwidth Product