

Silicon Tuning Diode

These devices are designed in the popular PLASTIC PACKAGE for high volumerequirements of FM Radio and TV tuning and AFC, general frequency control andtuning applications.They provide solid–state reliability in replacement of mechanical tuning methods. Also available in Surface Mount Package up to 33pF.

- High Q
- Controlled and Uniform Tuning Ratio
- Standard Capacitance Tolerance —10%
- Complete Typical Design Curves

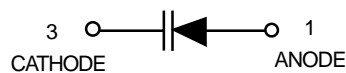

MMBV2101LT1
MMBV2103LT1
MMBV2105LT1
MMBV2107LT1
MMBV2108LT1
MMBV2109LT1
MV2101 MV2104
MV2106 MV2108
MV2109 MV2111
MV2115

6.8-100p
30 VOLTS
VOLTAGE VARIABLE
CAPACITANCE DIODES

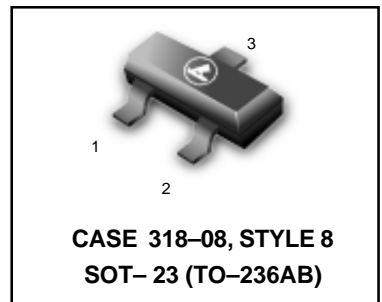

MAXIMUM RATINGS(EACH DIODE)

Rating	Symbol	MV21XX	MMBV21XXLT1	Unit
Reverse Voltage	V_R	30		Vdc
Forward Current	I_F	200		mAdc
Forward power Dissipation @ $T_A = 25^\circ\text{C}$	P_D	280	225	m W
Derate above 25°C		2.8	1.8	mW/°C
Junction Temperature	T_J	+150		°C
Storage Temperature Range	T_{stg}	-55 to +150		°C

DEVICE MARKING

MMBV2101LT1=M4G	MMBV2107LT1=4W
MMBV2103LT1=4H	MMBV2108LT1=4X
MMBV2105LT1=4U	MMBV2109LT1=4J

ELECTRICAL CHARACTERISTICS($T_A=25^\circ\text{C}$ unless otherwise noted)

Characteristic	Symbol	Min	Typ	Max	Unit
Reverse Breakdown Voltage ($I_R=1.0\mu\text{Adc}$)	$V_{(BR)R}$	30	—	—	Vdc
Reverse Voltage Leakage Current ($V_R=25\text{Vdc}, T_A=25^\circ\text{C}$)	I_R	—	—	0.1	μAdc
Diode Capacitance Temperature Coefficient ($V_R=4.0\text{Vdc}, f=1.0\text{MHz}$)	TC_C	—	280	—	ppm/°C

**MMBV2101LT1 MMBV2103LT1 MMBV2105LT1
MMBV2107LT1 MMBV2108LT1 MMBV2109LT1
MV2101 MV2104 MV2105 MV2108 MV2109
MV2111 MV2115**

Device	C _T , Diode Capacitance V _R = 4.0 Vdc, f = 1.0 MHz pF			Q, Figure of Merit V _R = 4.0 Vdc, f = 50 MHz	T _R , Tuning Ratio C ₂ /C ₃₀ f = 1.0 MHz		
	Min	Nom	Max	Typ	Min	Typ	Max
MMBV2101LT1/MV2101	6.1	6.8	7.5	450	2.5	2.7	3.2
MMBV2103LT1	9.0	10	11	400	2.5	2.9	3.2
MV2104	10.8	12	13.2	400	2.5	2.9	3.2
MMBV2105LT1/MV2105	13.5	15	16.5	400	2.5	2.9	3.2
MMBV2107LT1	19.8	22	24.2	350	2.5	2.9	3.2
MMBV2108LT1/MV2108	24.3	27	29.7	300	2.5	3.0	3.2
MMBV2109LT1/MV2109	29.7	33	36.3	200	2.5	3.0	3.2
MV2111	42.3	47	51.7	150	2.5	3.0	3.2
MV2115	90	100	110	100	2.6	3.0	3.3

MMBV2101LT1, MMBV2103LT1, MMBV2105LT1, MMBV2107LT1 thru MMBV2109LT1, are also available in bulk. Use the device title and drop the "T1" suffix when ordering any of these devices in bulk.

PARAMETER TEST METHODS

1. C_T, DIODE CAPACITANCE

(C_T = C_C + C_J). C_T is measured at 1.0 MHz using a ca-pacitance bridge (Boonton Electronics Model 75A or equivalent).

2. T_R, TUNING RATIO

T_R is the ratio of C_T measured at 2.0 Vdc divided by C_T measured at 30 Vdc.

3. Q, FIGURE OF MERIT

Q is calculated by taking the G and C readings of an ad-mittance bridge at the specified frequency and substituting in the following equations:

$$Q = \frac{2\pi f C}{G}$$

(Boonton Electronics Model 33As8 or equivalent). Use Lead Length ≈ 1/16".

4. TC_C, DIODE CAPACITANCE TEMPERATURE COEFFICIENT

TC_C is guaranteed by comparing C_T at V_R=4.0Vdc, f=1.0MHz, T_A= -65°C with C_T at V_R=4.0Vdc, f=1.0MHz, T_A= +85°C in the following equation, which defines TC_C:

$$TC_C = \left| \frac{C_T(+85^\circ C) - C_T(-65^\circ C)}{85+65} \right| \cdot \frac{10^6}{C_T(25^\circ C)}$$

Accuracy limited by measurement of C_T to ±0.1pF.

MMBV2101LT1 MMBV2103LT1 MMBV2105LT1
 MMBV2107LT1 MMBV2108LT1 MMBV2109LT1
 MV2101 MV2104 MV2105 MV2108 MV2109
 MV2111 MV2115

TYPICAL DEVICE CHARACTERISTICS

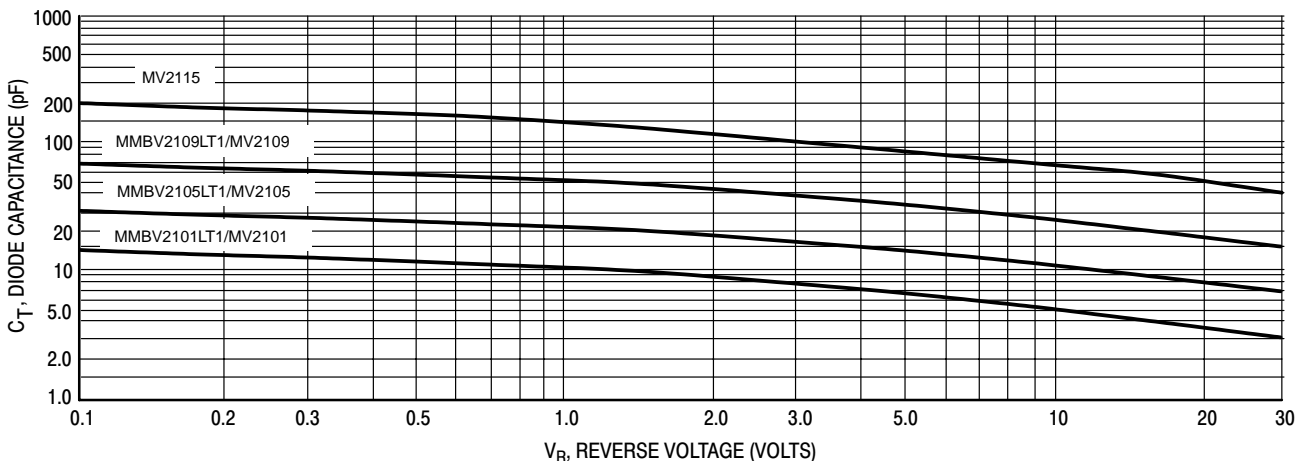

Figure 1. Diode Capacitance versus Reverse Voltage

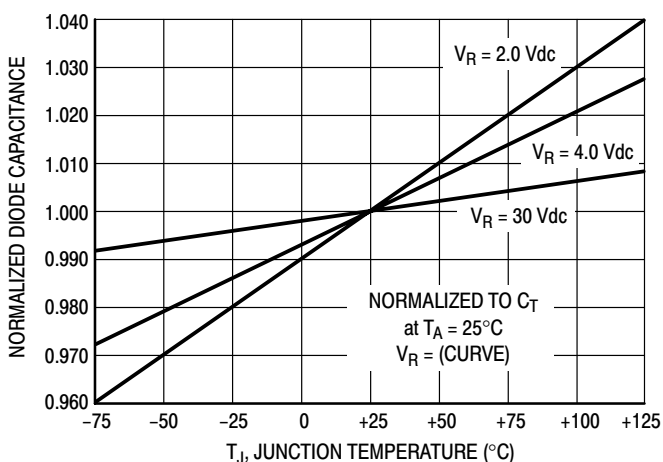

Figure 2. Normalized Diode Capacitance versus Junction Temperature

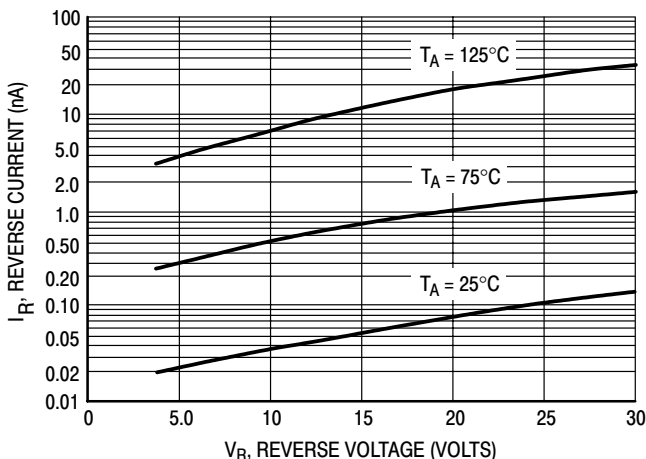

Figure 3. Reverse Current versus Reverse Bias Voltage

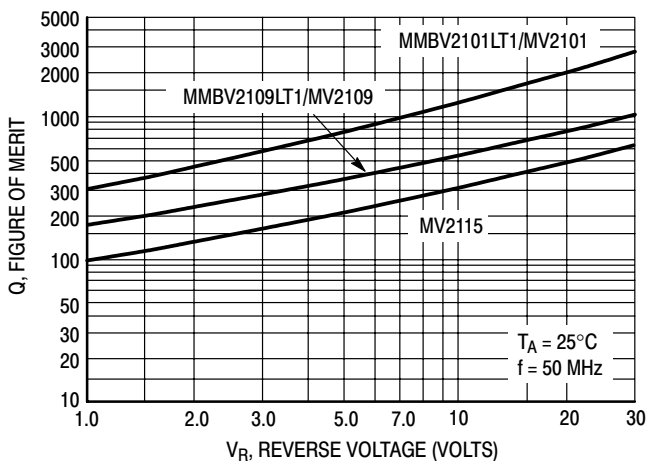

Figure 4. Figure of Merit versus Reverse Voltage

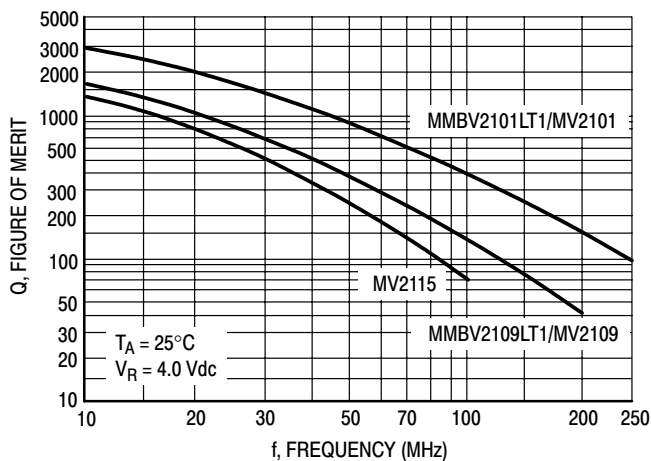

Figure 5. Figure of Merit versus Frequency