

Low Noise Amplifier

1400 - 2000 MHz

AM50-0006

V2.00

Features

- Low Noise Figure: 1.6 dB
- High Input IP3: -6 dBm at 3 V, 6.5 mA bias
- High Gain: 18 dB
- Single Supply: +3 to +8 VDC
- Low Cost SOT-26 Miniature Plastic Package
- Adjustable current: 3 to 20 mA with an external resistor

Description

M/A-COM's AM50-0006 is a high dynamic range, GaAs MMIC, low noise amplifier in a low cost, SOT-26 miniature surface mount, plastic package. It employs external input matching to obtain optimum noise figure performance and operating frequency flexibility. The AM50-0006 also features flexible biasing to control the current consumption vs. dynamic range trade-off. The AM50-0006 can operate from any positive supply voltage in the 3 V to 8 V range. Its current can be controlled over a range of 3 mA to 20 mA with an external resistor.

The AM50-0006 is ideally suited for use where low noise figure, high gain, high dynamic range, and low power consumption are required. Typical applications include receiver front ends in PDC-1500, DCS-1800, DCS-1900, PHS and other PCN/PCS applications. It is also useful as a gain block, buffer, driver and IF amplifier in both fixed and portable PDC, PHS, and PCN/PCS systems.

The AM50-0006 is fabricated using a low-cost 0.5-micron gate length GaAs process. The process features full passivation for increased performance reliability. The AM50-0006 is 100% RF tested to ensure performance specification compliance.

SOT-26

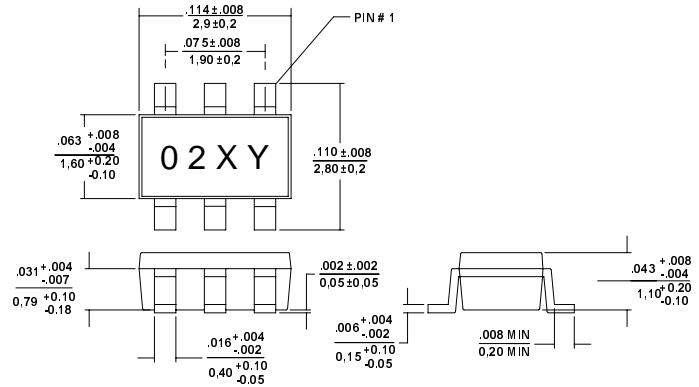

Ordering Information

Part Number	Package
AM50-0006	SOT-26 Plastic Package
AM50-0006TR	Forward Tape and Reel*
AM50-0006PDC	1400-1520 MHz Designer's Kit
AM50-0006PCS	1700-2000 MHz Designer's Kit

* If specific reel size is required, consult factory for part number assignment.

Electrical Specifications¹: T_A = +25°C, Z₀ = 50 Ω, P_{IN} = -30 dBm

Parameter	Test Conditions	Units	1500 MHz			1900 MHz		
			Min.	Typ.	Max.	Min.	Typ.	Max.
Gain	V _{DD} = 3 Volts	dB	15	18	20	15	17.5	20
Noise Figure	V _{DD} = 3 Volts	dB		1.60	2.00		1.65	2.00
Input VSWR				2.2:1			1.5:1	
Output VSWR				1.5:1			1.5:1	
Output 1 dB Compression	V _{DD} = 3 Volts	dBm		1			0	
Input IP3	V _{DD} = 3 Volts	dBm		-5.0			-6.0	
Reverse Isolation		dB		35			35	
Drain current	V _{DD} = 3 Volts	mA	4.5	6.5	10	4.5	6.5	10

1. Using external 120 Ω resistor. See functional block diagrams on pages 2 and 5.

Specifications Subject to Change Without Notice.

M/A-COM, Inc.

North America: Tel. (800) 366-2266
Fax (800) 618-8883

♦ Asia/Pacific: Tel. +81 3 3263-8761
Fax +81 3 3263-8769

♦ Europe: Tel. +44 (1344) 869-595
Fax +44 (1344) 300-020

Absolute Maximum Ratings ¹

Parameter	Absolute Maximum
V _{DD}	+10 VDC
Input Power	+17 dBm
Current ²	30 mA
Channel Temperature ³	+150°C
Operating Temperature	-40°C to +85°C
Storage Temperature	-65°C to +150°C

1. Exceeding any one or combination of these limits may cause permanent damage.
2. When pin #2 is used to increase current. (See note 5.)
3. Thermal resistance (θ_{jc}) = +150°C/W.

Functional Block Diagram For 1700-2000 MHz Operation

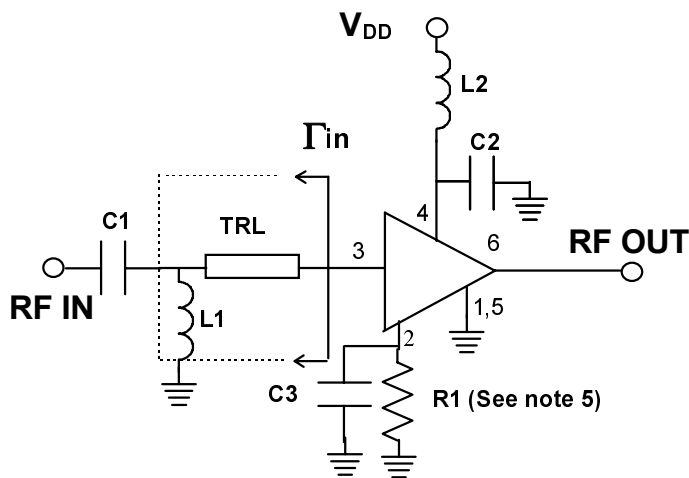

Recommended PCB Configuration For 1700-2000 MHz Operation

Layout View

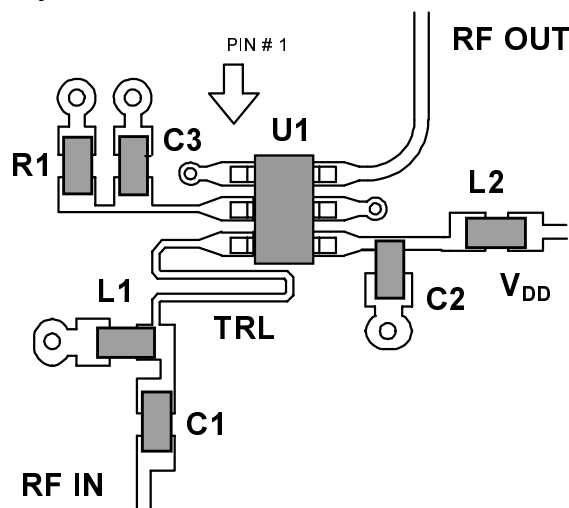

Specifications Subject to Change Without Notice.

Pin Configuration

Pin No.	Pin Name	Description
1	GND	RF and DC Ground
2	Rext Cext	External Current Control By-Pass Capacitor
3	IN	RF Input of the Amplifier
4	V _{DD}	Positive Supply Voltage
5	GND	RF and DC Ground
6	OUT	RF Output of the Amplifier

Input Reflection Coefficient 1700-2000 MHz Operation

Freq.	1700 MHz	1850 MHz	2000 MHz
Γ _{in} (mag)	0.699	0.674	0.649
Γ _{in} (ang)	48.47 °	38.68 °	29.27 °

External Circuitry Parts List For 1700-2000 MHz Operation ⁴

Part	Value	Purpose
C1	47 pF	DC Block
C2	470 pF	By-Pass
L1	2.7 nH	Tuning
L2	22 nH	RF Choke
R1	See Note 5	Current control
C3	470 pF	By-Pass

4. All external circuitry parts are readily available, low cost surface mount components (.060 in. x .030 in. or .080 in. x .050 in.).
5. Pin 2 allows use of an external resistor to ground for optional, higher current.
 For I_{DD} ~ 5 mA, R1 = 150 ohms;
 I_{DD} ~ 6.5 mA, R1 = 120 ohms;
 I_{DD} ~ 20 mA, R1 = 27 ohms.

Cross Section View

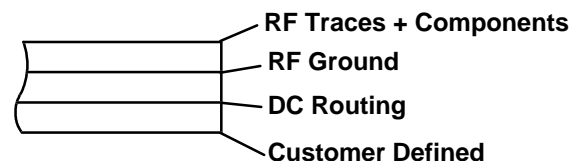

The PCB dielectric between RF traces and RF ground layers should be chosen to reduce RF discontinuities between 50 Ω lines and package pins. M/A-COM recommends an FR-4 dielectric thickness of 0.008" (0.20 mm) yielding a 50 Ω line width of 0.015" (0.38 mm). The recommended RF metalization is 1 ounce copper.

Typical 1700-2000 MHz Performance Data (when matched at input with Γ_{in} , see page 2)

Test Conditions: $T_A = +25^\circ\text{C}$, $Z_0 = 50 \Omega$, unless otherwise specified.

GAIN vs. FREQUENCY

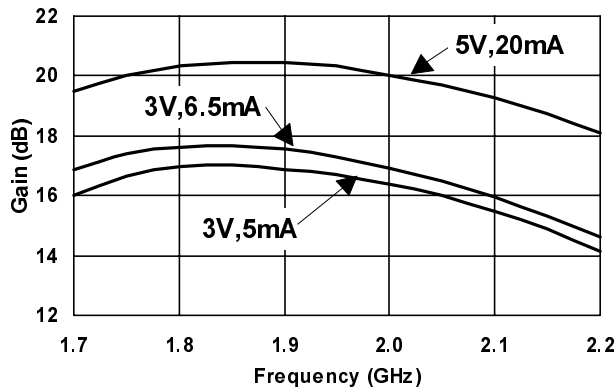

INPUT IP3 vs. FREQUENCY

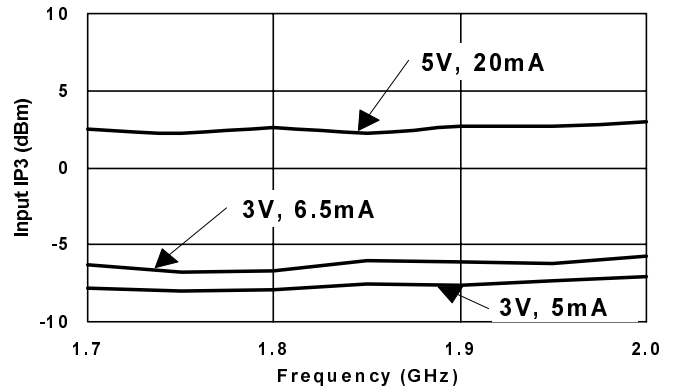

NOISE FIGURE vs. FREQUENCY (Bias = 3V, 6.5mA)

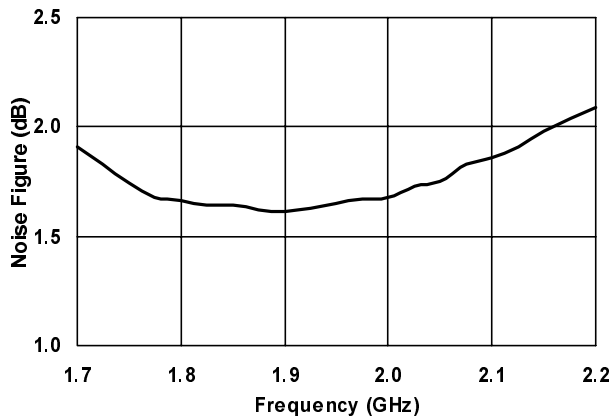

VSWR vs. FREQUENCY (Bias = 3V, 6.5mA)

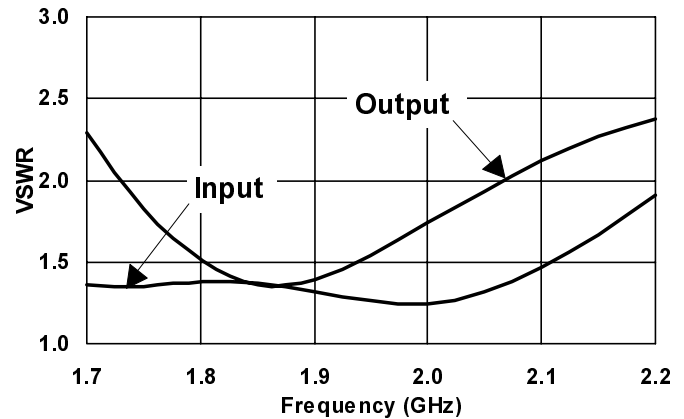

OUTPUT P1dB vs. FREQUENCY

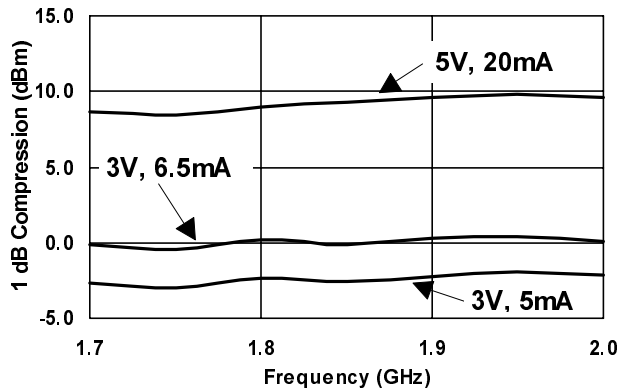

INPUT IP3 vs. DRAIN CURRENT (Freq. = 1900 MHz)

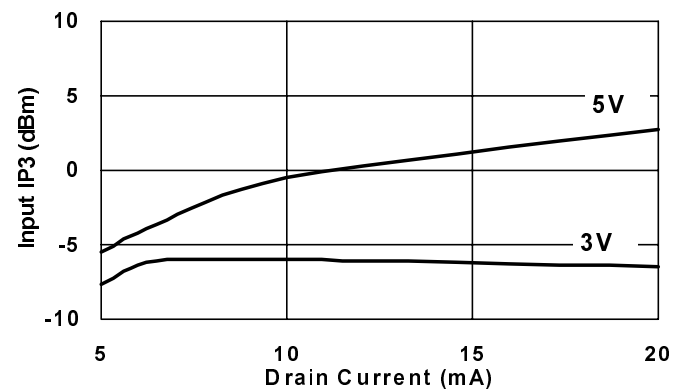

Specifications Subject to Change Without Notice.

Typical 1700-2000 MHz Performance Data cont. (when matched at input with Γ_{in} , see page 2)

Test Conditions: Bias = 3V, 6.5 mA, $Z_0 = 50 \Omega$, unless otherwise specified.

GAIN vs. TEMPERATURE

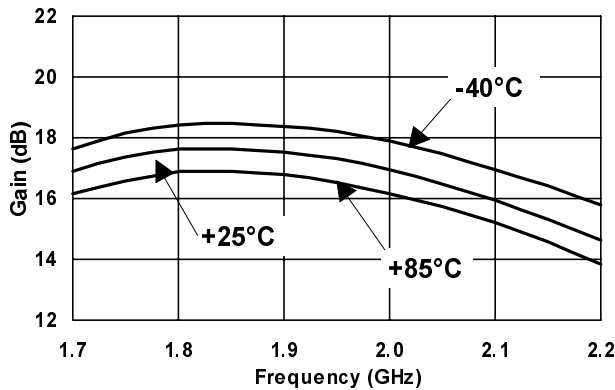

NOISE FIGURE vs. TEMPERATURE

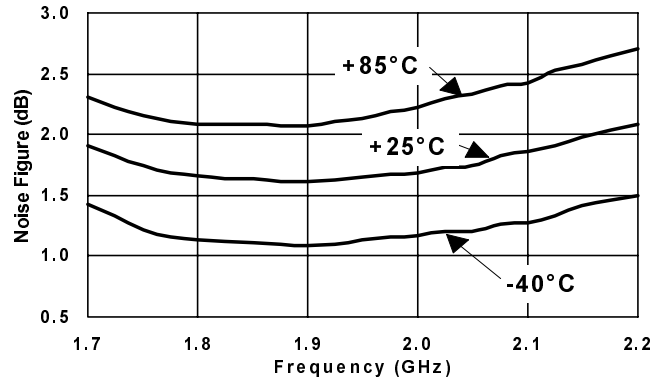

Designer's Kit AM50-0006PCS

The AM50-0006 Designer's Kit allows for immediate evaluation of M/A-COM's AM50-0006 tuned for 1700-2000 MHz operation. The Designer's Kit includes an AM50-0006, an evaluation board, and a floppy disk containing typical performance data and a DXF files of the recommended PCB layouts.

The evaluation board consists of the recommended external surface mount circuitry, RF connectors, and a DC multi-pin connector, all mounted to a multi-layer FR-4 PCB. The AM50-0006PCS evaluation PCB is illustrated below with all functional ports labeled.

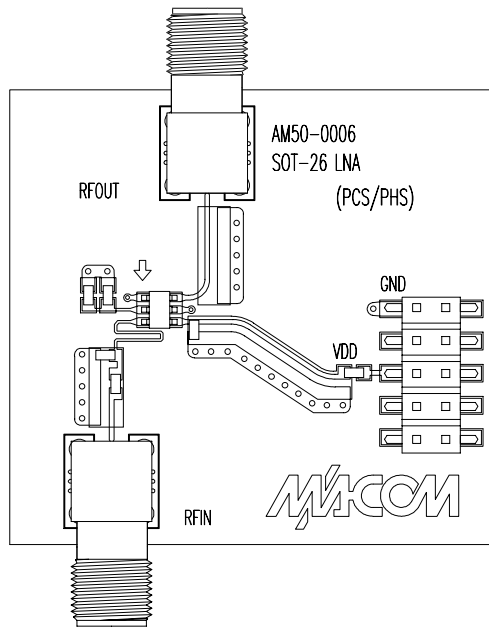

Evaluation PCB + RF Connector Losses

Port Reference	Approximate RF Loss
LNA Input	0.15 dB @ 1.90 GHz
LNA Output	0.15 dB @ 1.90 GHz

The DC connector on the Designer's Kit PCB allows convenient DC line access. This is accomplished by the one or more of the following methods:

1. A mating female multi-pin connector (Newark Electronics Stock # 46F-4658, not included).
2. Wires soldered to the necessary pins (not included).
3. Clip leads (not included).

AM50-0006PCS EVALUATION BOARD

Specifications Subject to Change Without Notice.

Absolute Maximum Ratings ¹

Parameter	Absolute Maximum
V _{DD}	+10 VDC
Input Power	+17 dBm
Current ²	30 mA
Channel Temperature ³	+150°C
Operating Temperature	-40°C to +85°C
Storage Temperature	-65°C to +150°C

1. Exceeding any one or combination of these limits may cause permanent damage.
2. When pin #2 is used to increase current. (See note 5.)
3. Thermal resistance (θ_{jc}) = +150°C/W.

Functional Block Diagram For 1400-1520 MHz Operation

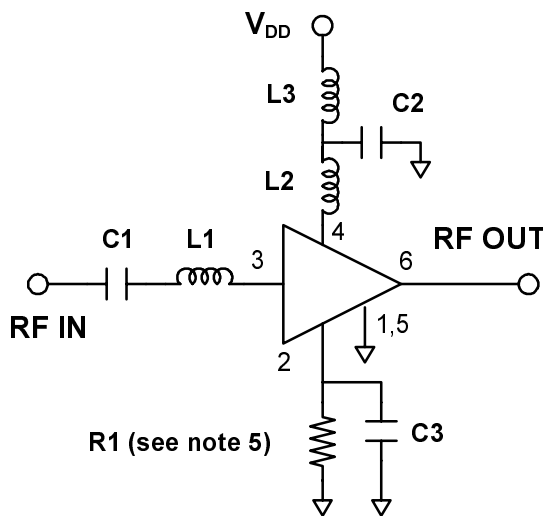

Pin Configuration

Pin No.	Pin Name	Description
1	GND	RF and DC Ground
2	Rext Cext	External Current Control By-Pass Capacitor
3	IN	RF Input of the Amplifier
4	V _{DD}	Positive Supply Voltage
5	GND	RF and DC Ground
6	OUT	RF Output of the Amplifier

External Circuitry Parts List For 1400-1520 MHz Operation ⁴

Part	Value	Purpose
C1	47 pF	DC Block
C2	470 pF	By-Pass
L1	10 nH	Tuning
L2	3.9 nH	Tuning
L3	22 nH	RF Choke
R1	See Note 5	Current control
C3	470 pF	By-Pass

4. All external circuitry parts are readily available, low cost surface mount components (.060 in. x .030 in. or .080 in. x .050 in.).
5. Pin 2 allows use of an external resistor to ground for optional, higher current.
 For I_{DD} ~ 5 mA, R1 = 150 ohms;
 I_{DD} ~ 6.5 mA, R1 = 120 ohms;
 I_{DD} ~ 20 mA, R1 = 27 ohms.

Recommended PCB Configuration For 1400-1520 MHz Operation

Layout View

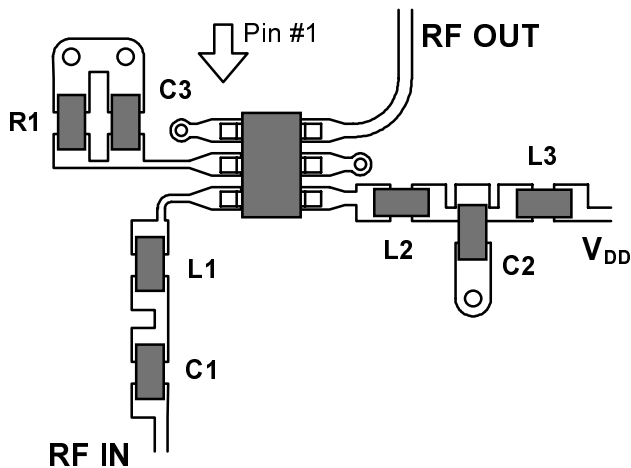

Cross Section View

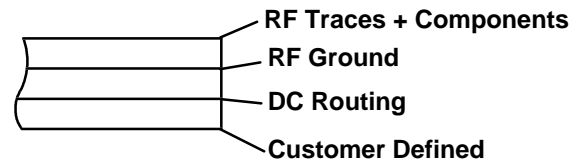

The PCB dielectric between RF traces and RF ground layers should be chosen to reduce RF discontinuities between 50 Ω lines and package pins. M/A-COM recommends an FR-4 dielectric thickness of 0.008" (0.20 mm) yielding a 50 Ω line width of 0.015" (0.38 mm). The recommended RF metalization is 1 ounce copper.

Specifications Subject to Change Without Notice.

M/A-COM, Inc.

North America: Tel. (800) 366-2266 ♦ Asia/Pacific: Tel. +81 3 3263-8761 ♦ Europe: Tel. +44 (1344) 869-595
 Fax (800) 618-8883 Fax +81 3 3263-8769 Fax +44 (1344) 300-020

Typical 1400-1520 MHz Performance Data (when matched as shown on page 5)

Test Conditions: $T_A = +25^\circ\text{C}$, $Z_0 = 50 \Omega$, unless otherwise specified.

GAIN vs. FREQUENCY

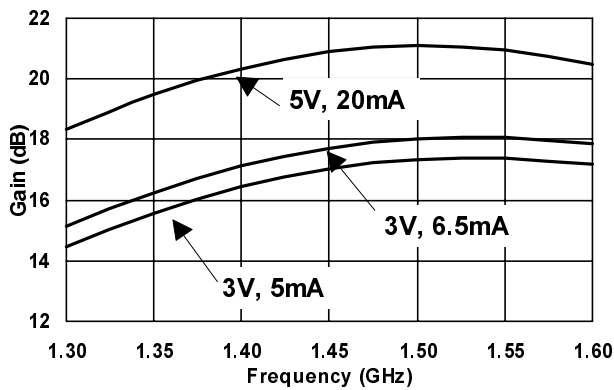

INPUT IP3 vs. FREQUENCY

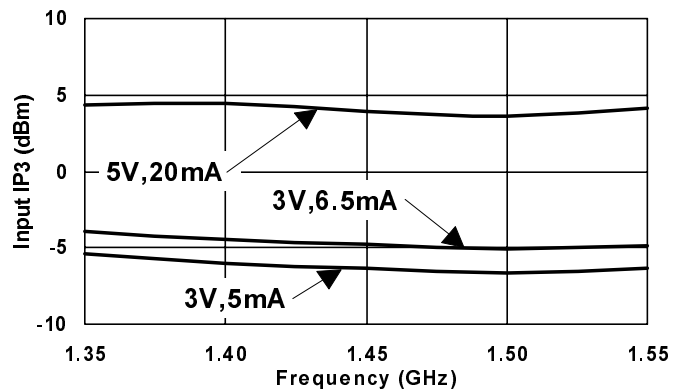

NOISE FIGURE vs. FREQUENCY (Bias = 3V, 6.5mA)

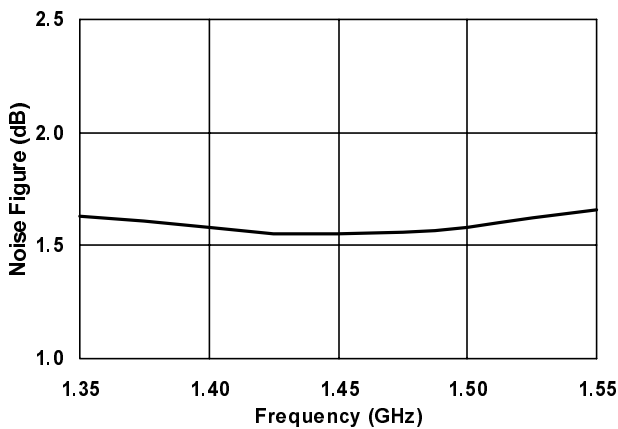

VSWR vs. FREQUENCY (Bias = 3V, 6.5mA)

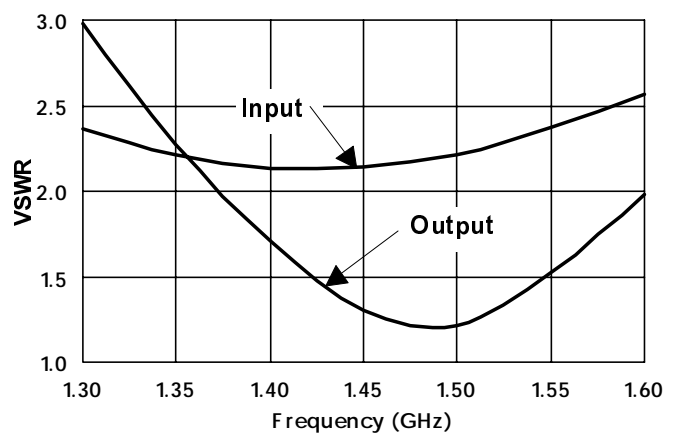

OUTPUT P1dB vs. FREQUENCY

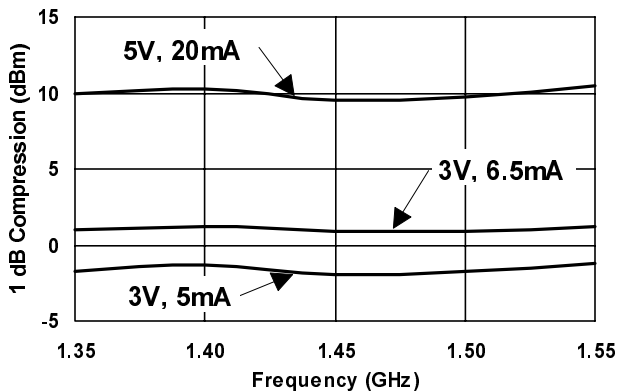

INPUT IP3 vs. DRAIN CURRENT (Freq. = 1500 MHz)

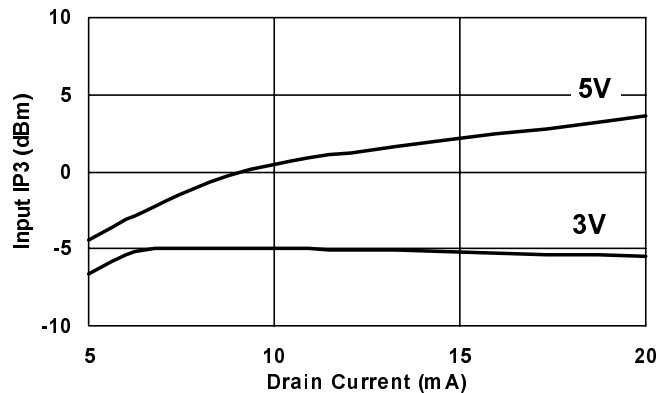

Specifications Subject to Change Without Notice.

Typical 1400-1520 MHz Performance Data cont. (when matched as shown on page 5)

Test Conditions: Bias=3V, 6.5 mA, $Z_0 = 50 \Omega$, unless otherwise specified.

GAIN vs. TEMPERATURE

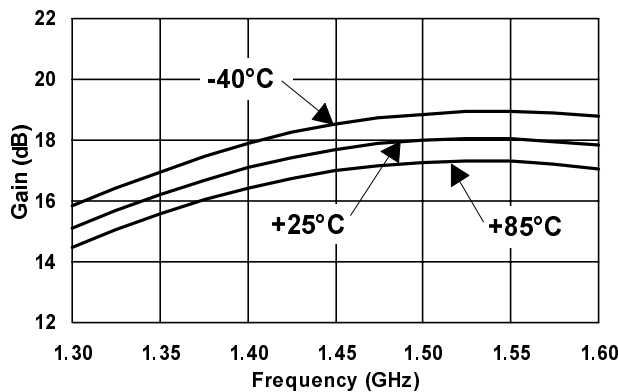

NOISE FIGURE vs. TEMPERATURE

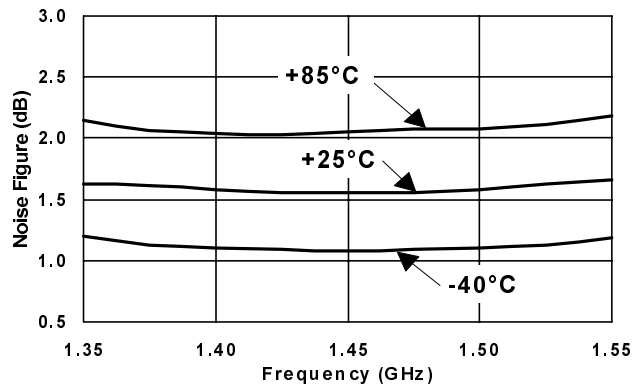

Designer's Kit AM50-0006PDC

The AM50-0006 Designer's Kit allows for immediate evaluation of M/A-COM's AM50-0006 tuned for 1400-1520 MHz operation. The Designer's Kit includes an AM50-0006, an evaluation board, and a floppy disk containing typical performance data and a DXF files of the recommended PCB layouts.

The evaluation board consists of the recommended external surface mount circuitry, RF connectors, and a DC multi-pin connector, all mounted to a multi-layer FR-4 PCB. The AM50-0006PDC evaluation PCB is illustrated below with all functional ports labeled.

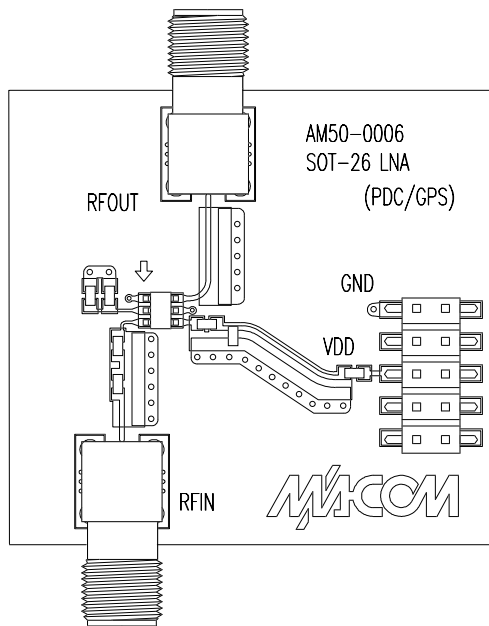

Evaluation PCB + RF Connector Losses

Port Reference	Approximate RF Loss
LNA Input	0.1 dB @ 1.50 GHz
LNA Output	0.1 dB @ 1.50 GHz

The DC connector on the Designer's Kit PCB allows convenient DC line access. This is accomplished by the one or more of the following methods:

1. A mating female multi-pin connector (Newark Electronics Stock # 46F-4658, not included).
2. Wires soldered to the necessary pins (not included).
3. Clip leads (not included).

AM50-0006PDC EVALUATION BOARD

Specifications Subject to Change Without Notice.

M/A-COM, Inc.

North America: Tel. (800) 366-2266 ♦ Asia/Pacific: Tel. +81 3 3263-8761 ♦ Europe: Tel. +44 (1344) 869-595
 Fax (800) 618-8883 ♦ Fax +81 3 3263-8769 ♦ Fax +44 (1344) 300-020