

Digital Attenuator, 4 Bit, Single Control, 15 dB 0.5 - 2.0 GHz



Features

- Single Control CMOS logic for each bit
- Attenuation: 1 dB steps to 15 dB
- Low DC Power Consumption: 50 uW
- Low Cost Plastic TSSOP - 16 Package

Description

The M/A-COM AT-226 is a 4 bit, 1 dB step GaAs MMIC digital attenuator in a low cost TSSOP-16 surface mount plastic package. The AT-226 is ideally suited for use where high accuracy, very low power consumption and low intermodulation products are required. Typical applications include radio, cellular, wireless LANs, GPS equipment and other gain/level control circuits.

The AT-226 is fabricated using mature 1 micron GaAs MESFET process. The process features full chip passivation for increased performance and reliability.

TSSOP-16

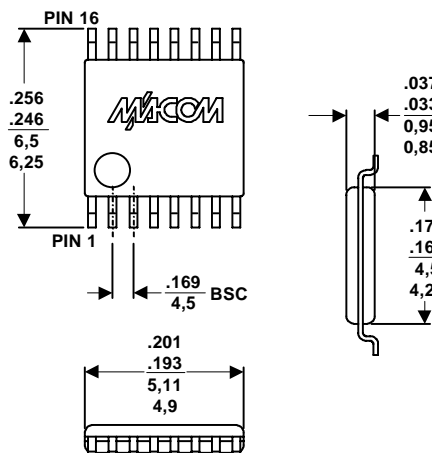

PIN Configuration

Pin No.	Function	Description
1,2,7,8	GND	RF Ground
3	VC1	Control 1
4	VC2	Control 2
5	VC3	Control 3
6	VC4	Control 4
9	RF2	RF in/out
10,11,12,13,14,15	GND	RF Ground
16	RF1	RF in/out

Functional Schematic^{1,2}

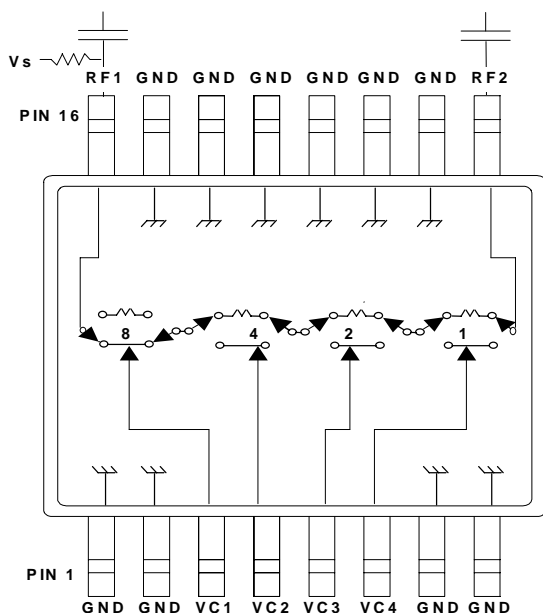

Truth Table^{1, 2, 3}

VC1	VC2	VC3	VC4	Attenuation (dB)
1	1	1	1	Reference I.L.
1	1	1	0	1
1	1	0	1	2
1	0	1	1	4
0	1	1	1	8
0	0	0	0	15

1. Logic 0 = 0 ± 0.2 V
2. Logic 1 = +5 V @ 30 μ A max. current total
3. $V_S = +5$ V

1. Required external blocking caps shown
2. V_S can be applied at RF1 or RF2 using a 10K Ω or greater pull-up resistor.

Electrical Specifications at T_A = +25°C

Parameter	Test Conditions	Units	Min.	Typ.	Max.
Reference Insertion Loss	0.5 - 1.0 GHz	dB		1.3	1.6
	1.0 - 2.0 GHz	dB		1.0	1.3
Attenuation Accuracy	0.5 - 1.0 GHz	±(0.25 dB + 5% of Attenuation setting in dB) dB			
	1.0-2.0 GHz	±(0.4 dB + 5% of Attenuation setting in dB) dB			
VSWR	0.5 - 2.0 GHz			1.3:1	1.8:1
Trise, Tfall		μs		2.5	
Ton, Toff		μs		1.0	
P _{1dB}	Input Power >0.5 GHz	dBm		24	
IP ₂	Measured Relative to Input Power Two Tone input up to 5dBm, 5MHz Spacing	>0.5GHz	dBm	80	
IP ₃	Measured Relative to Input Power Two Tone input up to 5dBm, 5MHz Spacing	>0.5GHz	dBm	47	

Typical Performance Curves

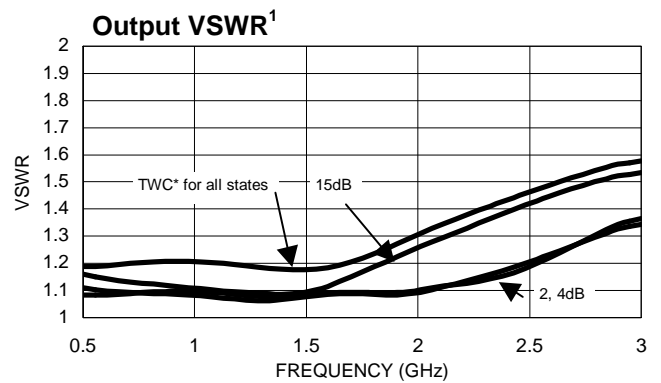
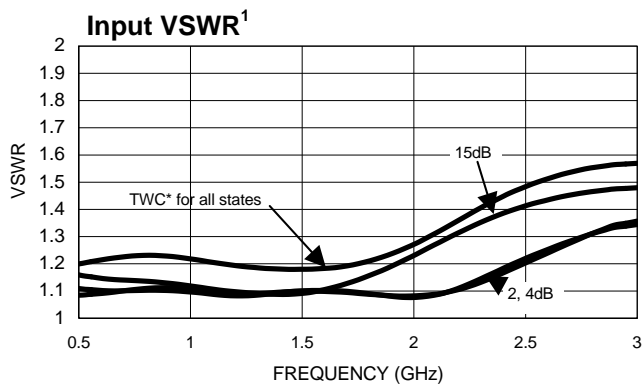
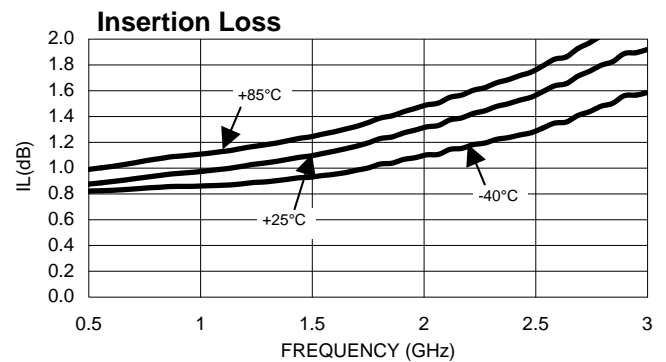
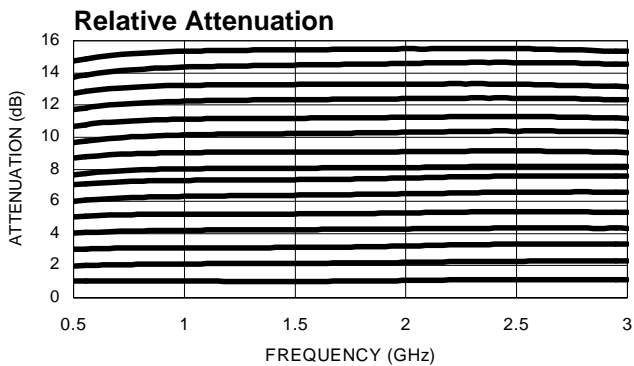

1. TWC = Typical worst case over all states

1. TWC = Typical worst case over all states

Typical Performance Curves (Cont'd)

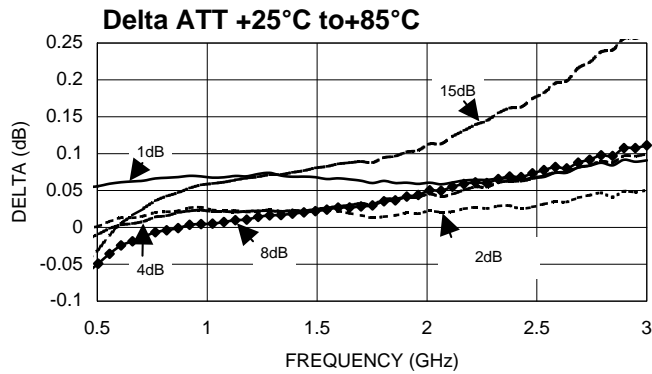
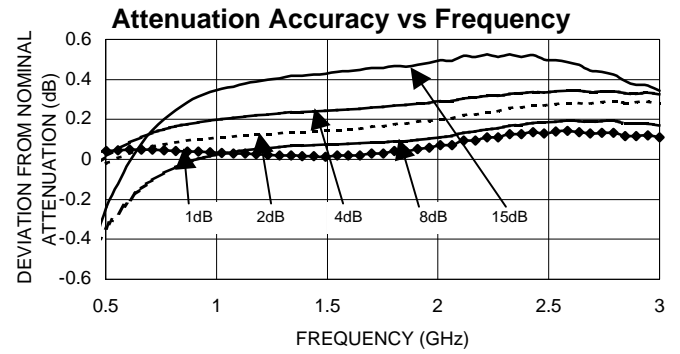
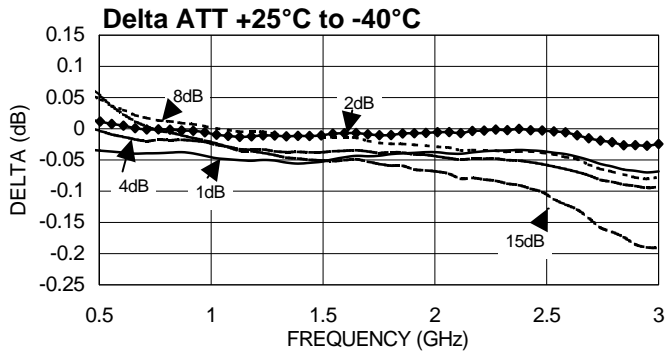

Absolute Maximum Ratings¹

Parameter	Maximum Ratings
Maximum Input Power	
50 MHz	+27 dBm
500 - 2000 MHz	+34 dBm
Control Voltage	+8 V, -1.0 V
Operating Temperature	-40°C to +85°C
Storage Temperature	-65°C to +150°C

1. Exceeding these limits may cause permanent damage.

