

RF MOSFET Power Transistor, 120W, 28V

2 - 175 MHz

DU28120V

V2.00

Features

- N-Channel Enhancement Mode Device
- DMOS Structure
- Lower Capacitances for Broadband Operation
- High Saturated Output Power
- Lower Noise Figure Than Competitive Devices

Absolute Maximum Ratings at 25°C

Parameter	Symbol	Rating	Units
Drain-Source Voltage	V_{DS}	65	V
Gate-Source Voltage	V_{GS}	20	V
Drain-Source Current	I_{DS}	12*	A
Power Dissipation	P_D	250	W
Junction Temperature	T_J	200	°C
Storage Temperature	T_{STJ}	-55 to +150	°C
Thermal Resistance	θ_{JC}	0.7	°C/W

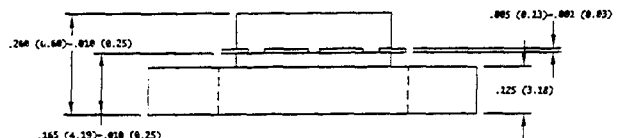
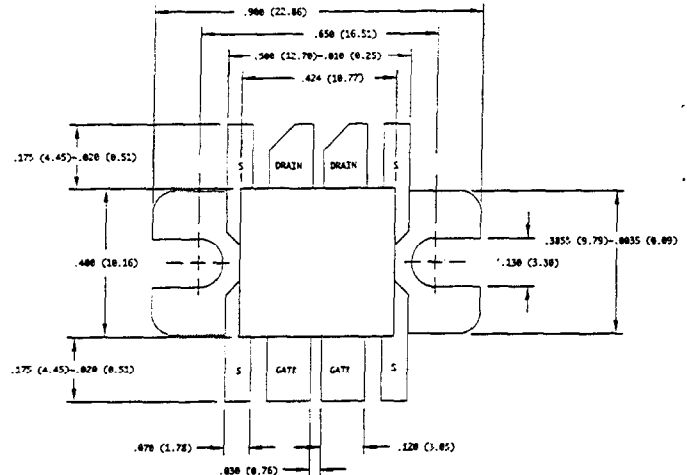

UNLESS OTHERWISE NOTED, TOLERANCES ARE
 INCHES - .005" (MILLIMETERS - 0.13MM)

Electrical Characteristics at 25°C

Parameter	Symbol	Min	Max	Units	Test Conditions
Drain-Source Breakdown Voltage	BV_{DSS}	65	-	V	$V_{GS}=0.0\text{ V}, I_{DS}=30.0\text{ mA}^*$
Drain-Source Leakage Current	I_{DSS}	-	6.0	mA	$V_{DS}=28.0\text{ V}, V_{GS}=0.0\text{ V}^*$
Gate-Source Leakage Current	I_{GSS}	-	6.0	μA	$V_{GS}=20.0\text{ V}, V_{DS}=0.0\text{ V}^*$
Gate Threshold Voltage	$V_{GS(TH)}$	2.0	6.0	V	$V_{DS}=10.0\text{ V}, I_{DS}=600.0\text{ mA}^*$
Forward Transconductance	G_M	3.0	-	S	$V_{DS}=10.0\text{ V}, I_{DS}=6000.0\text{ A}, \Delta V_{GS}=1.0\text{ V}, 80\text{ }\mu\text{s Pulse}^*$
Input Capacitance	C_{ISS}	-	270	pF	$V_{DS}=28.0\text{ V}, F=1.0\text{ MHz}^*$
Output Capacitance	C_{OSS}	-	240	pF	$V_{DS}=28.0\text{ V}, F=1.0\text{ MHz}^*$
Reverse Capacitance	C_{RSS}	-	48	pF	$V_{DS}=28.0\text{ V}, F=1.0\text{ MHz}^*$
Power Gain	G_P	13	-	dB	$V_{DS}=28.0\text{ V}, I_{DQ}=600\text{ mA}, P_{OUT}=120.0\text{ W}, F=175\text{ MHz}$
Drain Efficiency	η_D	60	-	%	$V_{DS}=28.0\text{ V}, I_{DQ}=600\text{ mA}, P_{OUT}=120.0\text{ W}, F=175\text{ MHz}$
Return Loss	R_L	10	-	%	$V_{DS}=28.0\text{ V}, I_{DQ}=600\text{ mA}, P_{OUT}=120.0\text{ W}, F=175\text{ MHz}$
Load Mismatch Tolerance	VSWR-T	-	30:1	-	$V_{DS}=28.0\text{ V}, I_{DQ}=600\text{ mA}, P_{OUT}=120.0\text{ W}, F=175\text{ MHz}$

* Per side

Specifications Subject to Change Without Notice.

M/A-COM, Inc.

North America: Tel. (800) 366-2266
 Fax (800) 618-8883

Asia/Pacific: Tel. +81 (03) 3226-1671
 Fax +81 (03) 3226-1451

Europe: Tel. +44 (1344) 869 595
 Fax +44 (1344) 300 020

Typical Broadband Performance Curves

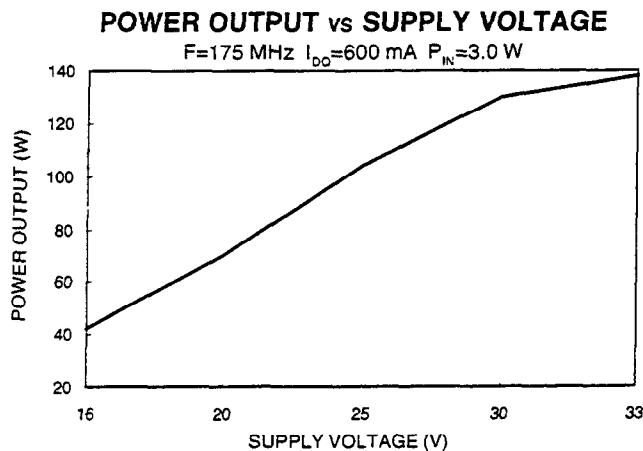
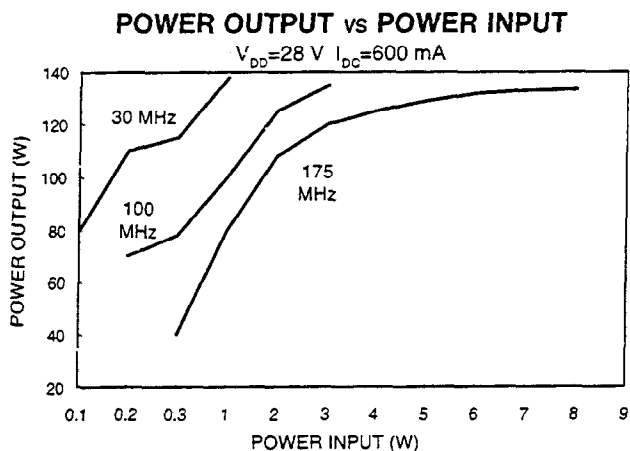
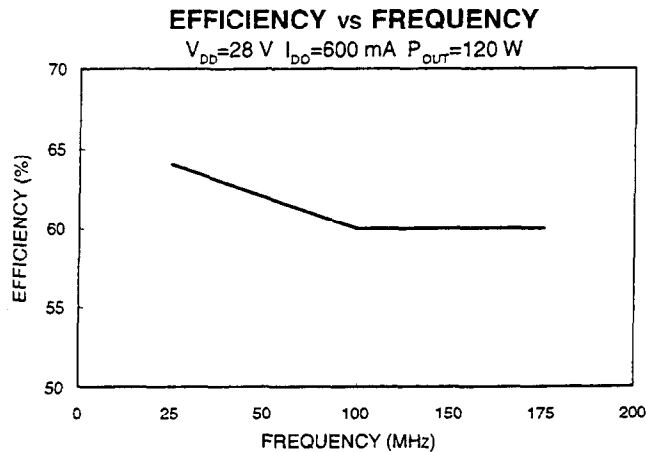
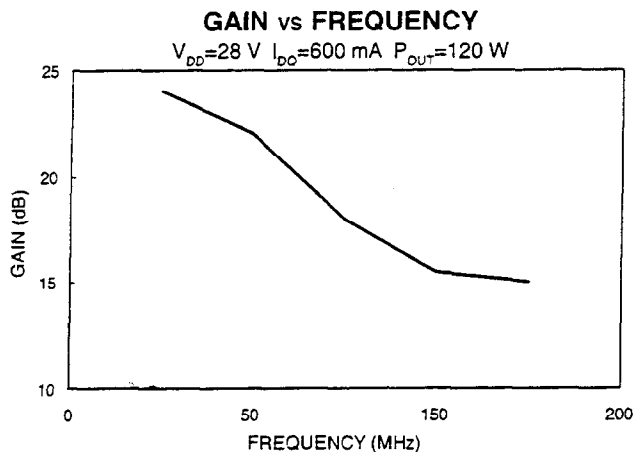

Specifications Subject to Change Without Notice.

M/A-COM, Inc.

North America: Tel. (800) 366-2266
 Fax (800) 618-8883

Asia/Pacific: Tel. +81 (03) 3226-1671
 Fax +81 (03) 3226-1451

Europe: Tel. +44 (1344) 869 595
 Fax +44 (1344) 300 020

Typical Device Impedance

Frequency (MHz)	Z _{IN} (OHMS)	Z _{LOAD} (OHMS)
30	3.0 - j 12.5	8.0 + j 6.0
100	1.5 - j 8.5	7.0 + j 6.5
175	1.0 - j 6.0	6.5 + j 5.0

V_{DD}=28 V, I_{DD}=600 mA, P_{OUT}=120 Watts

Z_{IN} is the series equivalent input impedance of the device from gate to gate.

Z_{LOAD} is the optimum series equivalent load impedance as measured from drain to drain.

RF Test Fixture

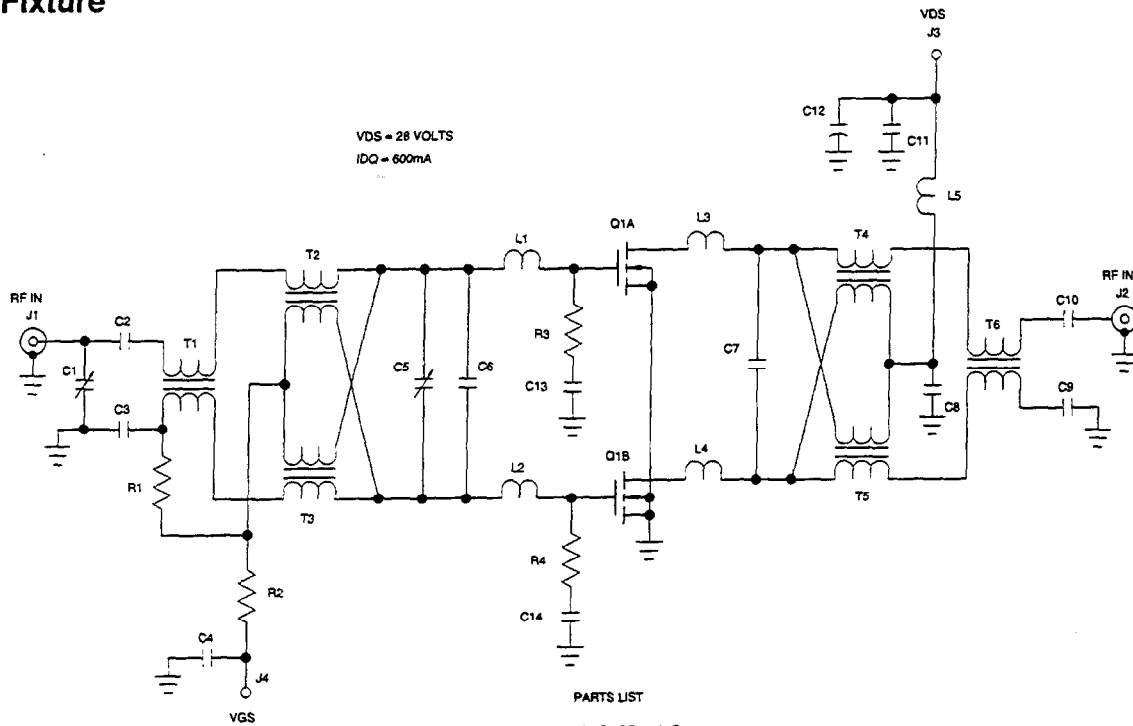

PARTS LIST

- C1 TRIMMER CAPACITOR 4-40pF
- C2,C3,C4, CAPACITOR 0.001pF
- C8,C9,C10
- C11,C13,C14
- C5 TRIMMER CAPACITOR 5-80pF
- C6 CAPACITOR 68pF
- C7 CAPACITOR 50pF
- C12 ELECTROLYTIC CAPACITOR 100uF 50 VOLTS
- L1,L2 0.50" X 0.10" TRACE ON BOARD + '0.125" X '0.25" LOOP
- L3,L4 0.87" X 0.10" TRACE ON BOARD
- L5 7.5 TURNS OF NO. 20 AWG COPPER WIRE X '0.31"
- R1,R3,R4 RESISTOR 18 OHMS 2 WATTS
- R2 RESISTOR 10K OHMS
- T1,T6 50 OHM BALUN CORES, 2 TURNS OF 50 OHM COAX THRU 2 STACKPOLE 57-1522
- T2,T3,T4 4:1 TRANSFORMER 2 TURNS OF 2 50 OHM COAX THRU
- T5 2 STACKPOLE 57-1522 BALUN CORES
- Q1 DU28120V
- BOARD FR4 0.062"

Specifications Subject to Change Without Notice.

MA-COM, Inc.

North America: Tel. (800) 366-2266
Fax (800) 618-8883

Asia/Pacific: Tel. +81 (03) 3226-1671
Fax +81 (03) 3226-1451

Europe: Tel. +44 (1344) 869 595
Fax +44 (1344) 300 020