

FEATURES

- 8.5 to 12.0 GHz Operation
- 10W CW Power Handling Capability
- 50Ω Input Impedance
- Excellent Return Loss
- Self-Aligned MSAG® MESFET Process

Balanced Three Stage LNA with Limiter

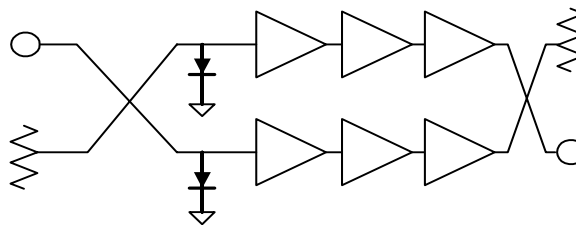

DESCRIPTION

The MA01503D is a balanced, three-stage low noise amplifier and limiter die fabricated using M/A-COM's mature GaAs Self-Aligned MSAG® MESFET Process. This product is fully matched to 50 ohms on both the input and the output.

MAXIMUM RATINGS (T_A = 25 °C unless otherwise noted)

Rating	Symbol	Value	Unit
DC Drain Supply Voltage	V _{DD}	8	Vdc
DC Gate Supply Voltage	V _{GG}	-6	Vdc
RF Input Power	P _{IN}	15	W
Junction Temperature	T _J	150	°C
Storage Temperature	T _{STG}	-40 to +150	°C

ELECTRICAL CHARACTERISTICS V_{DD}=5.0 V, V_{GG}=-5.0 V, T=25 °C, Input and Output Connected to 50 Ω System.

Characteristic	Symbol	Min	Typ	Max	Unit
Frequency Range	f	8.5	—	12.0	GHz
Gain	G	17	19	23	dB
1dB Compression Point	P _{1db}		+20		dBm
Gain Flatness (Peak-to-Peak over any 250 MHz band)	—	—	0.6	1.5	dB
Noise Figure	NF	—	2.7	3.5	dB
Input Third Order Intercept Point	TOI		8		dBm
Input and Output Return Loss	RL	13	20	—	dB
Drain Bias voltage	V _{DD}	—	5	—	VDC
Gate Bias Voltage	V _{GG}		-5		VDC
Drain Supply Current (No RF)	I _{DD}	—	—	240	mA
Drain Supply Current (Max @ Pin = 10 Watts)	I _{DD}	—	—	300	mA
Gate Supply Current	I _{GG}	—	—	45	mA
Power Handling Capability (CW up to 30 minutes continuous exposure)	P _{RF}	—	10	—	W



Specifications subject to change without notice.

■ **North America:** Tel. (800)366-2266, Fax (800)618-8883

■ **Asia/Pacific:** Tel. +81-44-844-8296, Fax +81-44-844-8298

■ **Europe:** Tel. +44 (1344) 869 595, Fax +44 (1344) 300 020

Visit www.macom.com for additional data sheets and product information

TYPICAL MEASURED GAIN AND NOISE FIGURE OF THE THREE-STAGE LIMITER/LNA

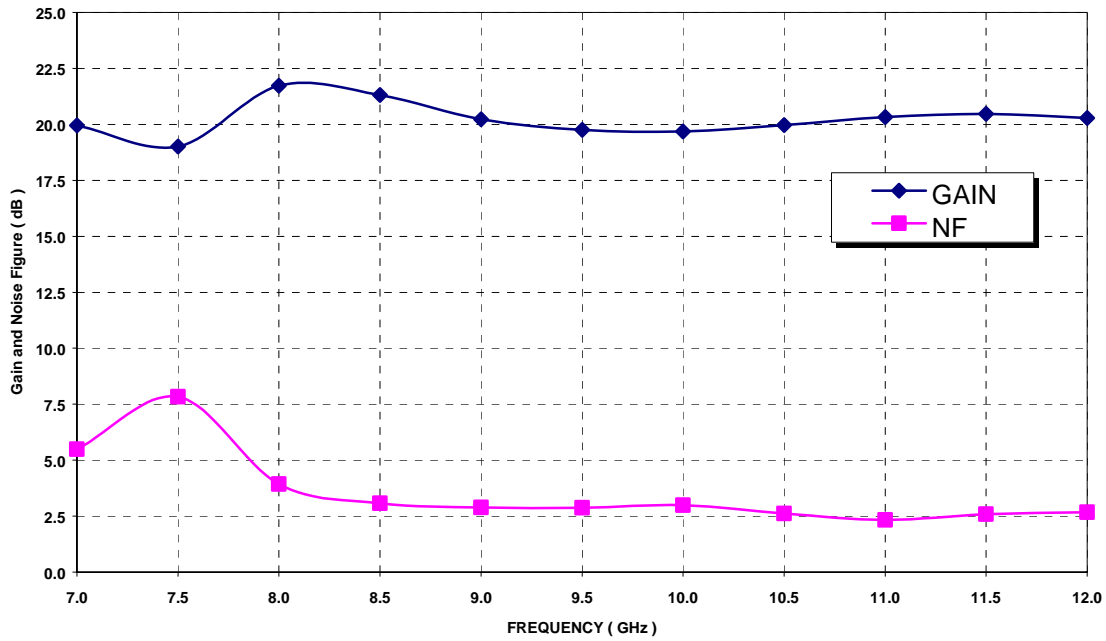

TYPICAL MEASURED S11 and S22 OF THE THREE-STAGE LIMITER/LNA

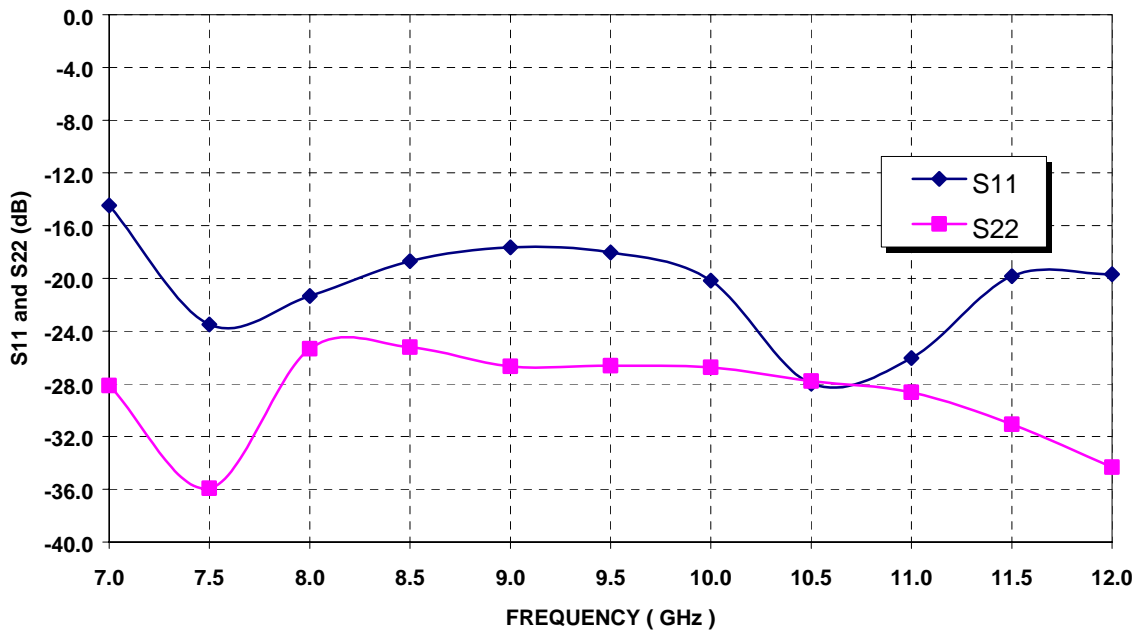

Specifications subject to change without notice.

- North America: Tel. (800)366-2266, Fax (800)618-8883
- Asia/Pacific: Tel. +81-44-844-8296, Fax +81-44-844-8298
- Europe: Tel. +44 (1344) 869 595, Fax +44 (1344) 300 020

903122



Visit www.macom.com for additional data sheets and product information

TYPICAL MEASURED GAIN OF THE LIMITER/LNA TESTED BEFORE AND AFTER 30 MINUTES EXPOSURE with 40 dBm CW Power

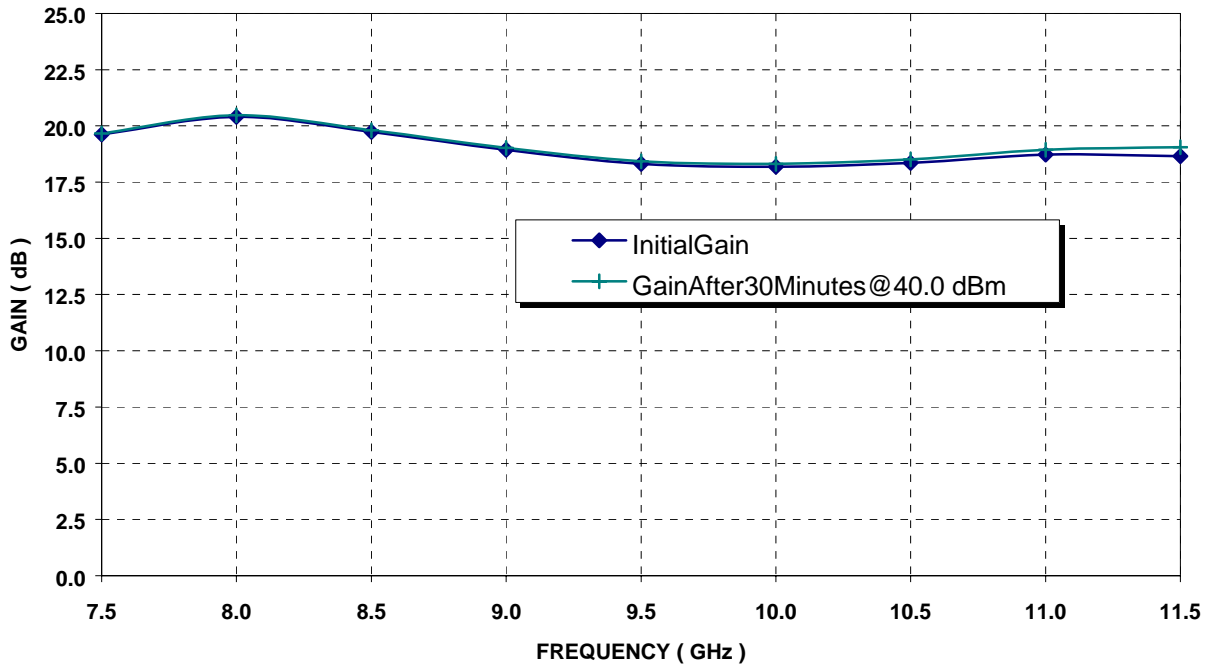

TYPICAL MEASURED NOISE FIGURE OF THE LIMITER/LNA TESTED BEFORE AND AFTER 30 MINUTES EXPOSURE with 40 dBm CW Power

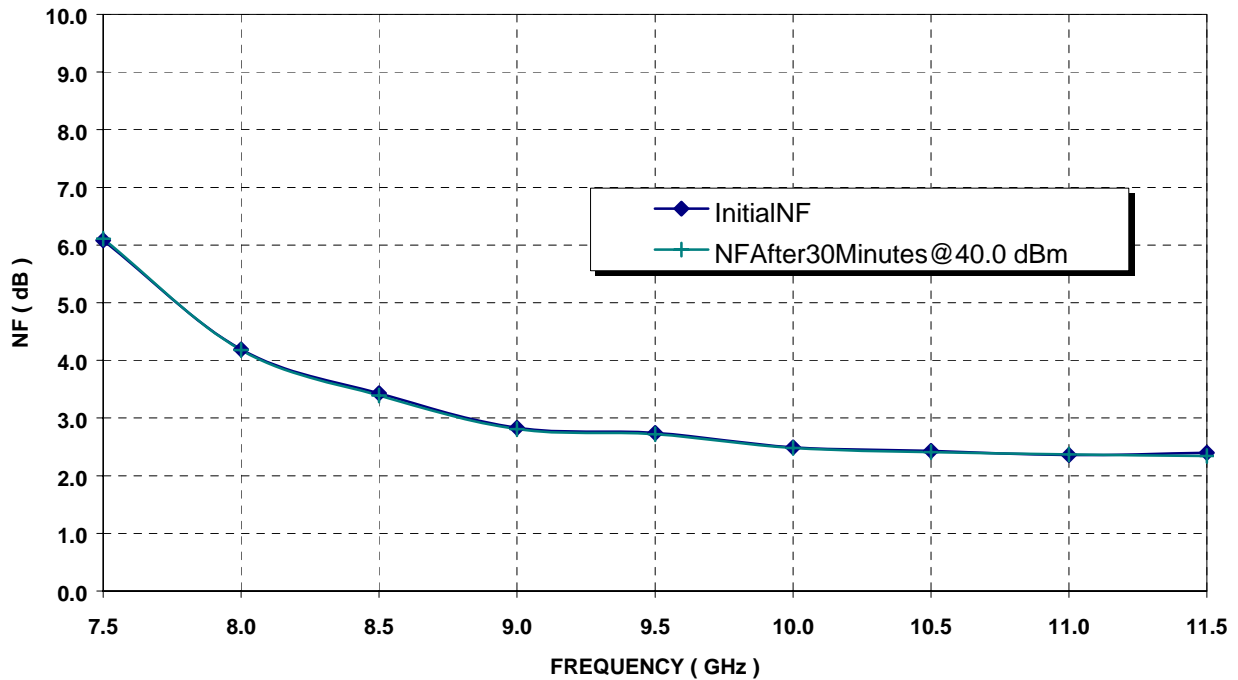

Specifications subject to change without notice.

- North America: Tel. (800)366-2266, Fax (800)618-8883
- Asia/Pacific: Tel. +81-44-844-8296, Fax +81-44-844-8298
- Europe: Tel. +44 (1344) 869 595, Fax +44 (1344) 300 020

903122

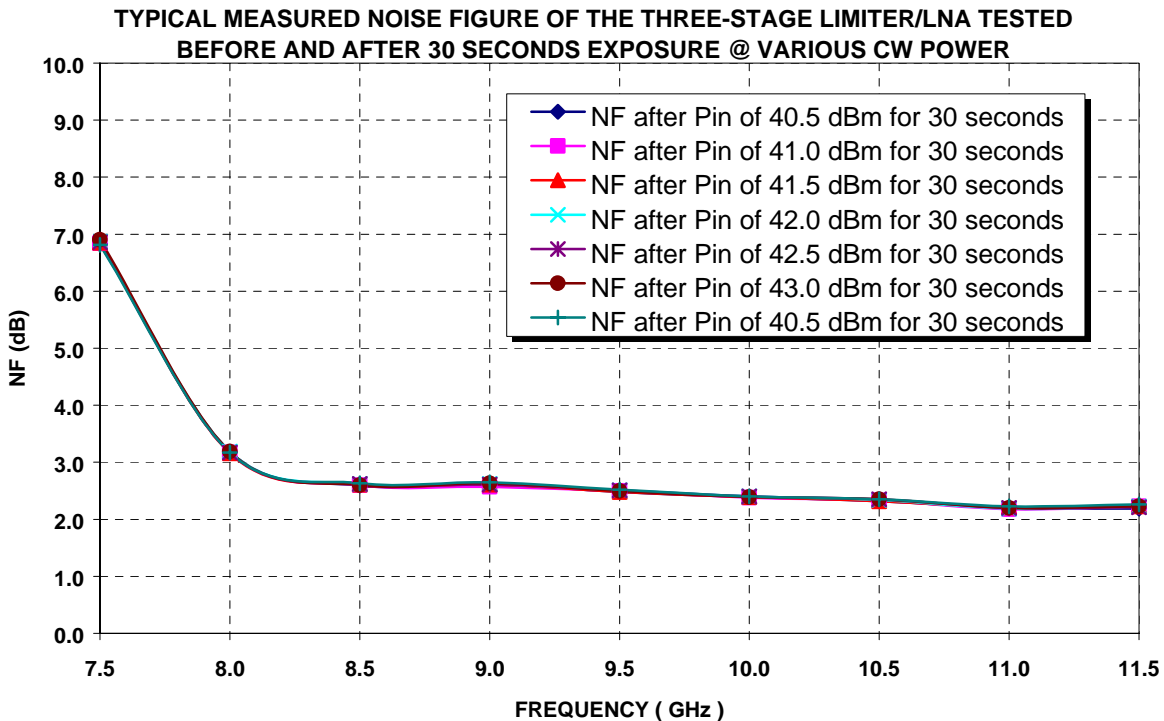
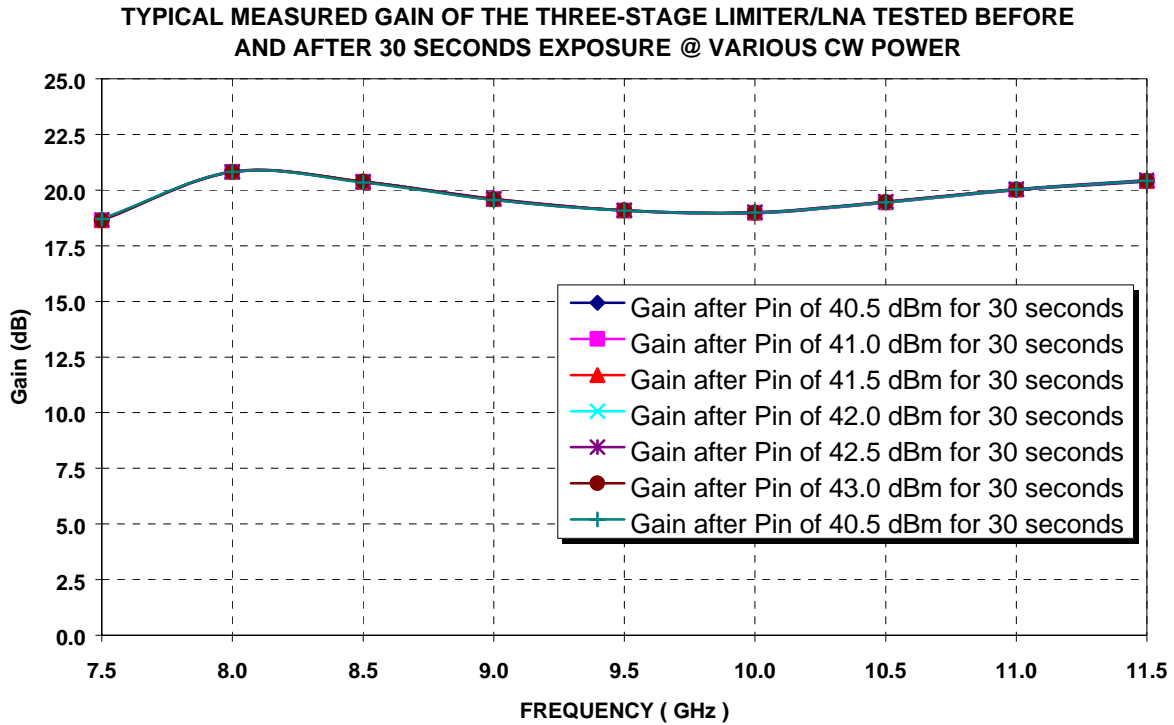

Specifications subject to change without notice.

■ North America: Tel. (800)366-2266, Fax (800)618-8883
 ■ Asia/Pacific: Tel. +81-44-844-8296, Fax +81-44-844-8298
 ■ Europe: Tel. +44 (1344) 869 595, Fax +44 (1344) 300 020

903122



Visit www.macom.com for additional data sheets and product information

MECHANICAL INFORMATION

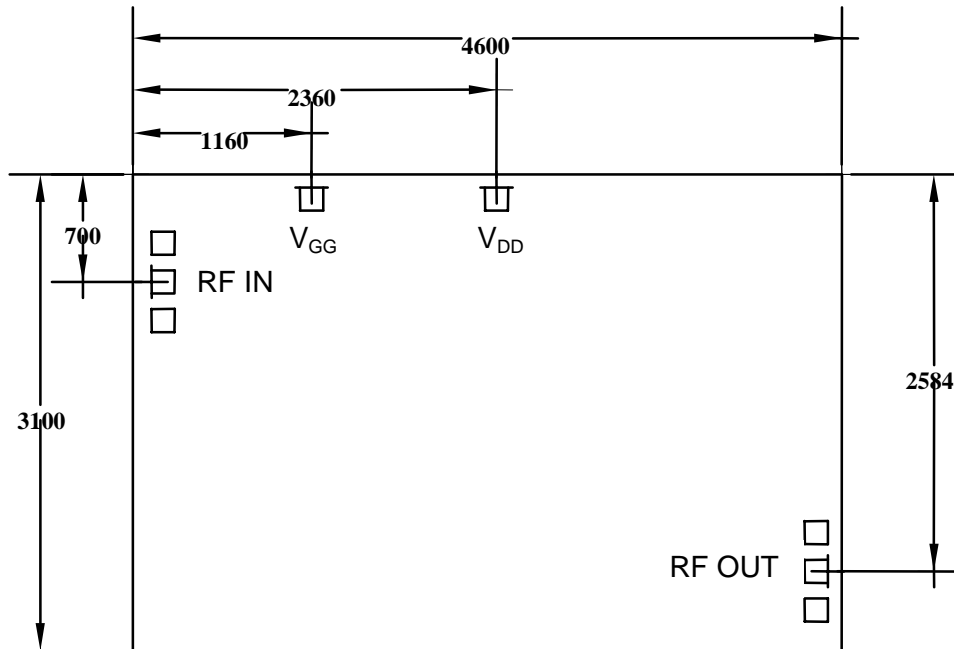

NOTES:

Dimensions in microns
Pad size 150 μm x 150 μm

Specifications subject to change without notice.

- North America: Tel. (800)366-2266, Fax (800)618-8883
- Asia/Pacific: Tel. +81-44-844-8296, Fax +81-44-844-8298
- Europe: Tel. +44 (1344) 869 595, Fax +44 (1344) 300 020

903122