

# The RF Line NPN Silicon High-Frequency Transistor

... designed for use in high-gain, low-noise, ultra-linear, tuned and wideband amplifiers. Ideal for use in CATV, MATV, and instrumentation applications.

- Low Noise Figure —  
NF = 3.0 dB (Typ) @ f = 500 MHz, I<sub>C</sub> = 90 mA
- High Power Gain —  
G<sub>U(max)</sub> = 16.5 dB (Typ) @ f = 500 MHz
- Ion Implanted
- All Gold Metal System
- High f<sub>T</sub> — 5.5 GHz
- Low Intermodulation Distortion:  
TB<sub>3</sub> = -70 dB  
DIN = 125 dB μV
- Nichrome Emitter Ballast Resistors

**MRF587**

NF = 3.0 dB @ 0.5 GHz  
HIGH-FREQUENCY  
TRANSISTOR  
NPN SILICON

## MAXIMUM RATINGS

Rating	Symbol	Value	Unit
Collector-Emitter Voltage	V <sub>CEO</sub>	17	Vdc
Collector-Base Voltage	V <sub>CBO</sub>	34	Vdc
Emitter-Base Voltage	V <sub>EBO</sub>	2.5	Vdc
Collector Current — Continuous	I <sub>C</sub>	200	mAdc
Total Device Dissipation @ T <sub>C</sub> = 50°C Derate above T <sub>C</sub> = 50°C	P <sub>D</sub>	5.0 33	Watts mW/°C
Storage Temperature Range	T <sub>stg</sub>	- 65 to +150	°C
Junction Temperature	T <sub>J</sub>	200	°C

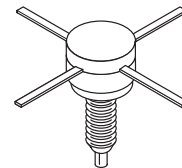

CASE 244A-01, STYLE 1

## ELECTRICAL CHARACTERISTICS (T<sub>C</sub> = 25°C unless otherwise noted.)

Characteristic	Symbol	Min	Typ	Max	Unit
----------------	--------	-----	-----	-----	------

### OFF CHARACTERISTICS

Collector-Emitter Breakdown Voltage (I <sub>C</sub> = 5.0 mAdc, I <sub>B</sub> = 0)	V <sub>(BR)CEO</sub>	17	—	—	Vdc
Collector-Base Breakdown Voltage (I <sub>C</sub> = 1.0 mAdc, I <sub>E</sub> = 0)	V <sub>(BR)CBO</sub>	34	—	—	Vdc
Emitter-Base Breakdown Voltage (I <sub>C</sub> = 0, I <sub>E</sub> = 0.1 mAdc)	V <sub>(BR)EBO</sub>	2.5	—	—	Vdc
Collector Cutoff Current (V <sub>CB</sub> = 10 Vdc, I <sub>E</sub> = 0)	I <sub>CBO</sub>	—	—	50	μAdc

### ON CHARACTERISTICS

DC Current Gain (1) (I <sub>C</sub> = 50 mAdc, V <sub>CE</sub> = 5.0 Vdc)	h <sub>FE</sub>	50	—	200	—
--	-----------------	----	---	-----	---

NOTE:

1. 300 μs pulse on Tektronix 576 or equivalent.

(continued)

**ELECTRICAL CHARACTERISTICS — continued** ( $T_C = 25^\circ\text{C}$  unless otherwise noted.)

Characteristic	Symbol	Min	Typ	Max	Unit
<b>DYNAMIC CHARACTERISTICS</b>					
Current-Gain — Bandwidth Product (2) ( $I_C = 90\text{ mA}$ , $V_{CE} = 15\text{ Vdc}$ , $f = 0.5\text{ GHz}$ )	$f_T$	—	5.5	—	GHz
Collector-Base Capacitance ( $V_{CB} = 10\text{ Vdc}$ , $I_E = 0$ , $f = 1.0\text{ MHz}$ )	$C_{cb}$	—	1.7	2.2	pF

**FUNCTIONAL TESTS**

Narrowband — Figure 15 ( $I_C = 90\text{ mA}$ , $V_{CC} = 15\text{ V}$ , $f = 0.5\text{ GHz}$ ) Noise Figure Power Gain at Optimum Noise Figure	NF $G_{NF}$	— 11	3.0 13	4.0 —	dB
Broadband — Figure 16 ( $I_C = 90\text{ mA}$ , $V_{CC} = 15\text{ V}$ , $f = 0.3\text{ GHz}$ ) Noise Figure Power Gain at Optimum Noise Figure	NF $G_{NF}$	— —	6.3 11	— —	dB
Triple Beat Distortion ( $I_C = 50\text{ mA}$ , $V_{CC} = 15\text{ V}$ , $P_{Ref} = 50\text{ dBmV}$ ) ( $I_C = 90\text{ mA}$ , $V_{CC} = 15\text{ V}$ , $P_{Ref} = 50\text{ dBmV}$ )	$TB_3$	—	-70	—	dB
DIN 45004 ( $I_C = 90\text{ mA}$ , $V_{CC} = 15\text{ V}$ ) ( $I_C = 90\text{ mA}$ , $V_{CC} = 15\text{ V}$ )	DIN	—	125	—	dB $\mu\text{V}$
Maximum Available Power Gain (3) ( $I_C = 90\text{ mA}$ , $V_{CE} = 15\text{ Vdc}$ , $f = 0.5\text{ GHz}$ )	$G_{Umax}$	—	16.5	—	dB

NOTES:

2. Characterized on HP8542 Automatic Network Analyzer

$$3. G_{Umax} = \frac{|S_{21}|^2}{(1-|S_{11}|^2)(1-|S_{22}|^2)}$$

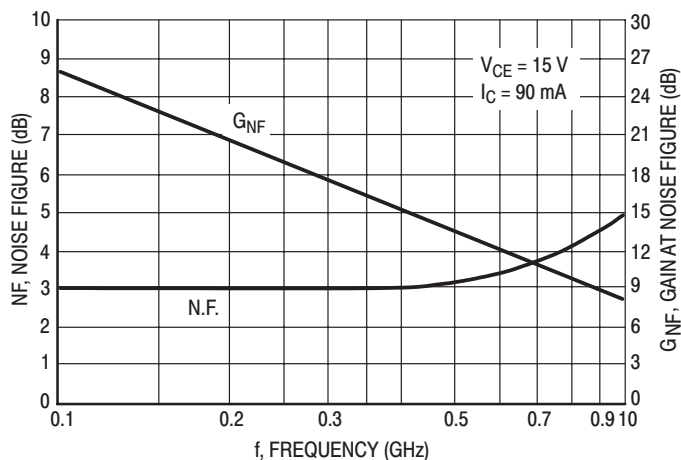

**Figure 1. Typical Noise Figure and Associated Gain versus Frequency**

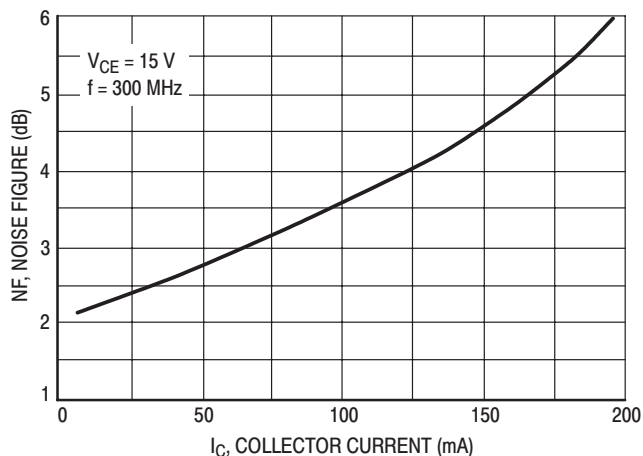

**Figure 2. Noise Figure versus Collector Current**

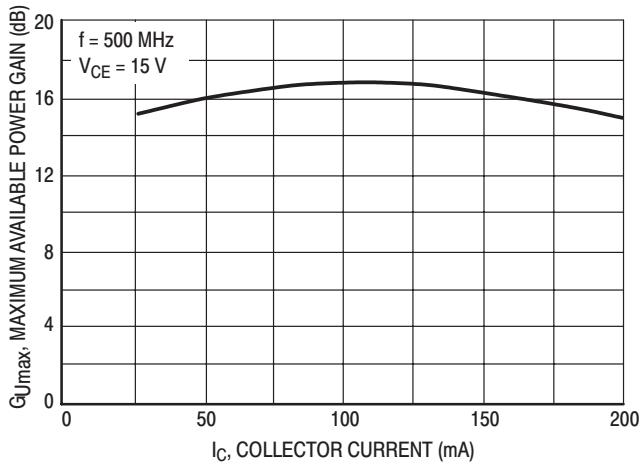

Figure 3.  $G_{Umax}$  versus Collector Current

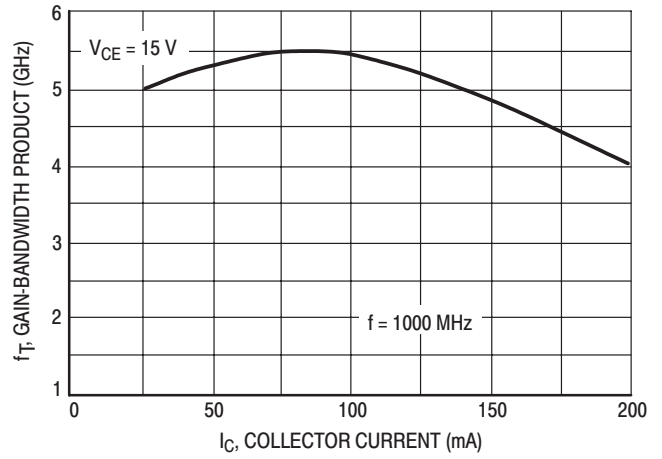

Figure 4. Gain-Bandwidth Product versus Collector Current

TYPICAL PERFORMANCE

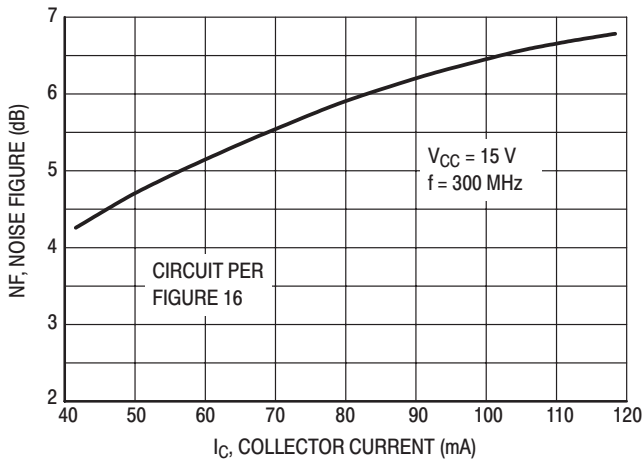

Figure 5. Broadband Noise Figure

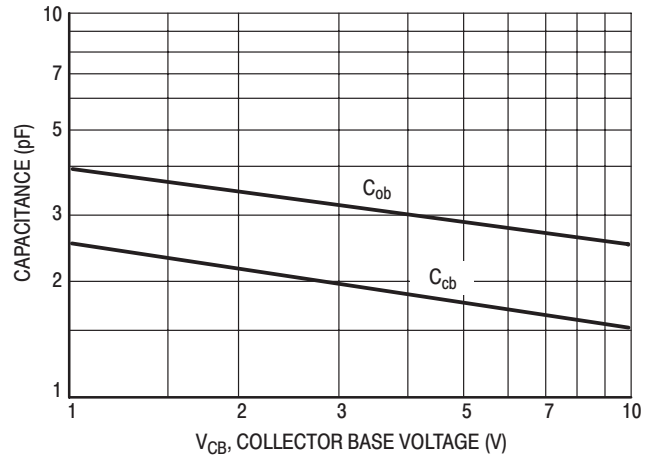

Figure 6. Junction Capacitance versus Voltage

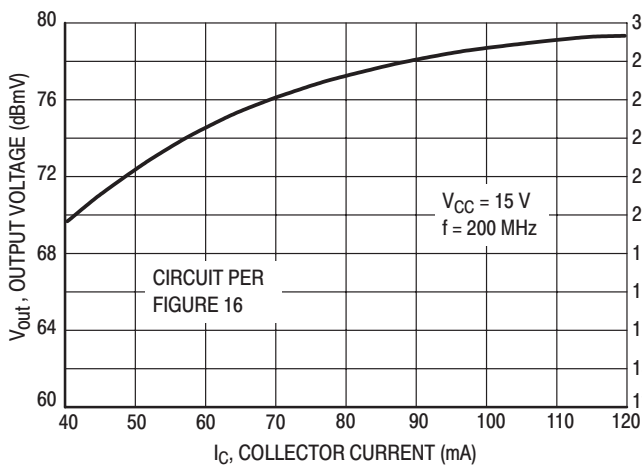

Figure 7. 1.0 dB Compression Point versus Collector Current

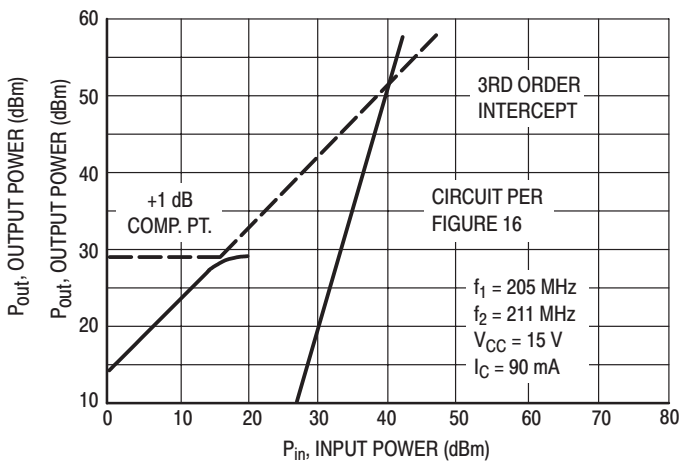

Figure 8. Third Order Intercept Point

TYPICAL PERFORMANCE (continued)

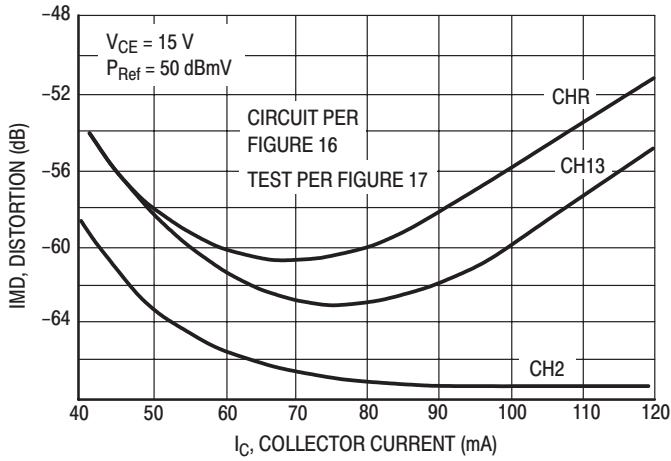

Figure 9. Second Order Distortion versus Collector Current

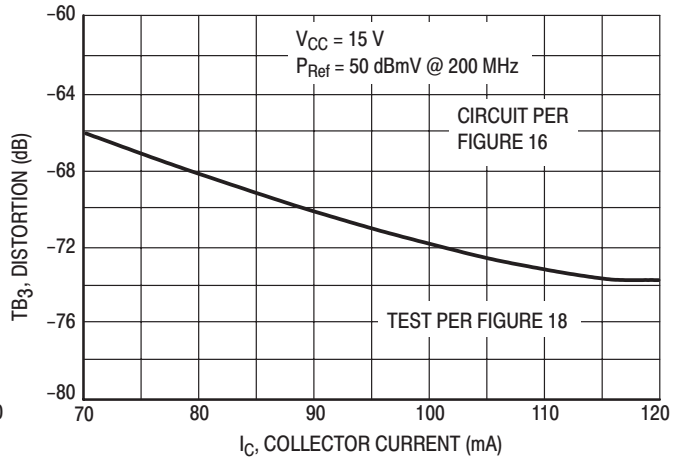

Figure 10. Triple Beat Distortion versus Collector Current

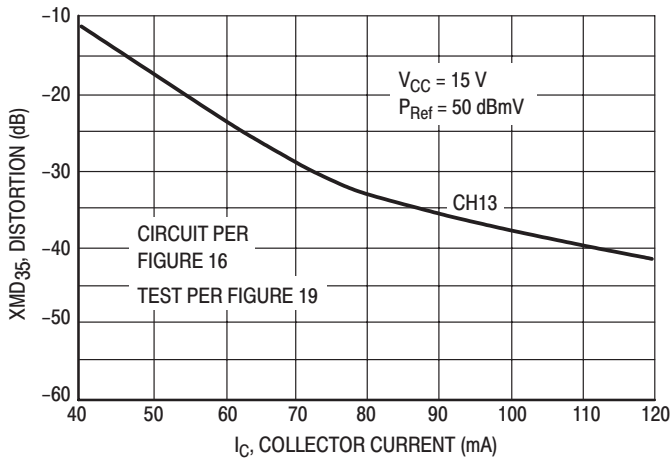

Figure 11. 35-Channel X-Modulation Distortion versus Collector Current

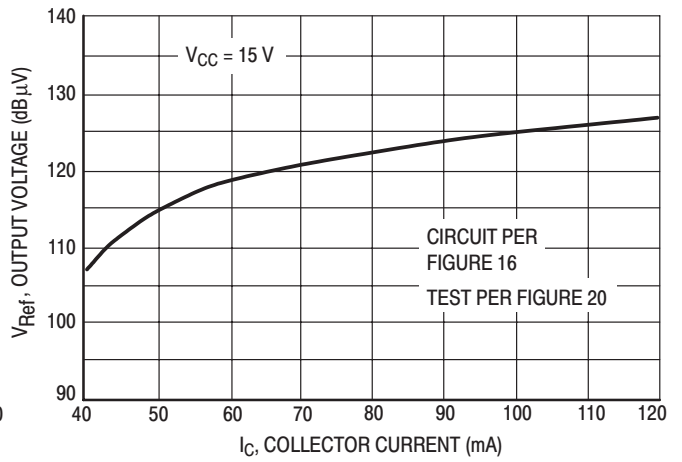

Figure 12. DIN 45004B versus Collector Current

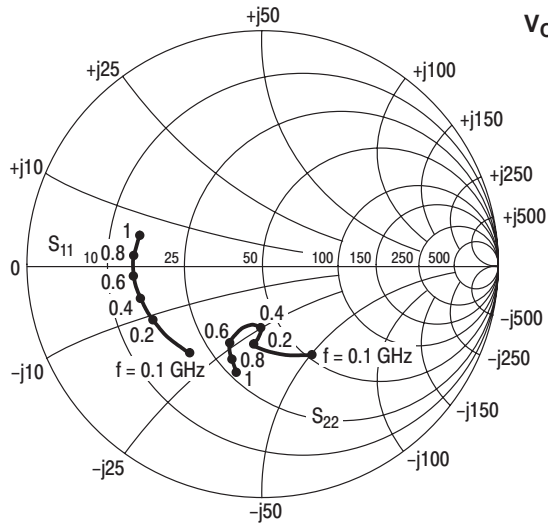

Figure 13. Input/Output Reflection Coefficient versus Frequency (GHz)

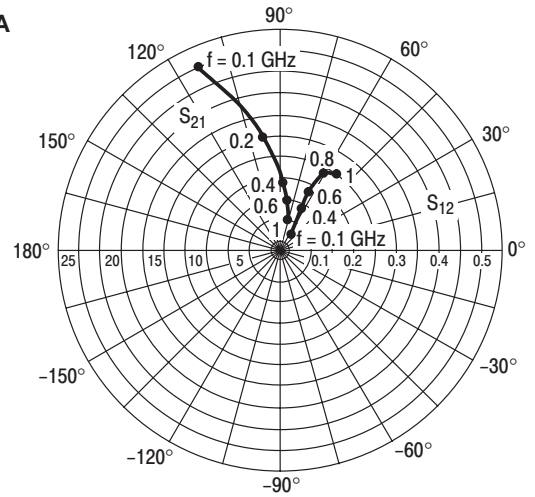

Figure 14. Forward/Reverse Transmission Coefficients versus Frequency (GHz)

V <sub>CE</sub> (Volts)	I <sub>C</sub> (mA)	f (MHz)	S <sub>11</sub>		S <sub>21</sub>		S <sub>12</sub>		S <sub>22</sub>	
			S <sub>11</sub>	∠φ	S <sub>21</sub>	∠φ	S <sub>12</sub>	∠φ	S <sub>22</sub>	∠φ
5.0	30	100	0.56	-131	16.45	113	0.04	45	0.49	-91
		200	0.58	-159	9.42	98	0.06	49	0.38	-116
		400	0.60	-178	5.00	86	0.08	55	0.35	-132
		600	0.64	170	3.61	76	0.11	56	0.38	-138
		800	0.67	162	2.92	67	0.14	55	0.41	-144
		1000	0.70	155	2.55	58	0.17	54	0.44	-152
	60	100	0.53	-141	17.89	110	0.04	50	0.47	-102
		200	0.56	-164	10.05	97	0.05	55	0.39	-126
		400	0.59	178	5.31	85	0.09	60	0.38	-141
		600	0.63	169	3.82	76	0.12	59	0.40	-146
		800	0.66	161	3.09	67	0.15	57	0.44	-153
		1000	0.69	155	2.67	58	0.18	55	0.47	-160
	90	100	0.52	-145	18.26	109	0.04	52	0.47	-106
		200	0.56	-166	10.20	96	0.05	57	0.39	-130
		400	0.59	177	5.38	85	0.09	62	0.39	-144
		600	0.63	168	3.86	76	0.12	60	0.41	-149
		800	0.66	161	3.12	67	0.15	58	0.45	-155
		1000	0.69	155	2.70	58	0.19	55	0.48	-162
10	30	100	0.53	-122	18.36	115	0.04	48	0.50	-75
		200	0.53	-153	10.63	100	0.05	51	0.36	-96
		400	0.55	175	5.71	87	0.08	57	0.33	-112
		600	0.59	173	4.16	78	0.10	58	0.35	-119
		800	0.62	165	3.37	68	0.13	57	0.39	-127
		1000	0.65	158	2.95	59	0.15	55	0.42	-136
	60	100	0.49	-132	20.19	112	0.03	51	0.46	-85
		200	0.51	-158	11.54	99	0.05	57	0.35	-107
		400	0.53	-178	6.12	87	0.08	61	0.33	-123
		600	0.58	171	4.43	78	0.11	60	0.36	-129
		800	0.60	164	3.58	68	0.14	59	0.40	-136
		1000	0.63	157	3.12	60	0.16	57	0.44	-144
	90	100	0.48	-135	20.82	111	0.03	53	0.45	-88
		200	0.50	-160	11.77	98	0.05	59	0.34	-111
		400	0.53	-179	6.22	86	0.08	63	0.33	-126
		600	0.57	171	4.50	78	0.11	62	0.36	-131
		800	0.60	164	3.64	68	0.14	59	0.41	-139
		1000	0.63	157	3.18	60	0.17	57	0.44	-147

(continued)

Table 1. Common-Emitter S-Parameters

V <sub>CE</sub> (Volts)	I <sub>C</sub> (mA)	f (MHz)	S <sub>11</sub>		S <sub>21</sub>		S <sub>12</sub>		S <sub>22</sub>	
			S <sub>11</sub>	∠φ	S <sub>21</sub>	∠φ	S <sub>12</sub>	∠φ	S <sub>22</sub>	∠φ
15	30	100	0.49	-112	20.34	118	0.04	54	0.51	-52
		200	0.52	-145	11.51	101	0.05	56	0.36	-77
		400	0.48	-164	6.12	87	0.09	63	0.32	-74
		600	0.52	-174	4.19	75	0.12	62	0.32	-90
		800	0.53	177	3.29	68	0.16	61	0.38	-90
		1000	0.53	168	2.76	61	0.20	56	0.47	-90
	60	100	0.45	-122	22.14	115	0.03	56	0.45	-60
		200	0.49	-150	12.24	99	0.05	60	0.33	-86
		400	0.45	-166	6.45	86	0.09	65	0.30	-83
		600	0.50	-175	4.42	75	0.13	63	0.32	-99
		800	0.51	177	3.47	68	0.16	61	0.38	-98
		1000	0.51	168	2.91	62	0.20	55	0.46	-96
	90	100	0.44	-127	22.76	114	0.03	58	0.43	-62
		200	0.48	-152	12.44	98	0.05	62	0.32	-89
		400	0.44	-167	6.55	85	0.09	66	0.29	-85
		600	0.50	-176	4.47	75	0.13	64	0.32	-102
		800	0.51	176	3.51	69	0.17	61	0.38	-100
		1000	0.51	168	2.95	62	0.20	55	0.46	-98

Table 1. Common-Emitter S-Parameters (continued)

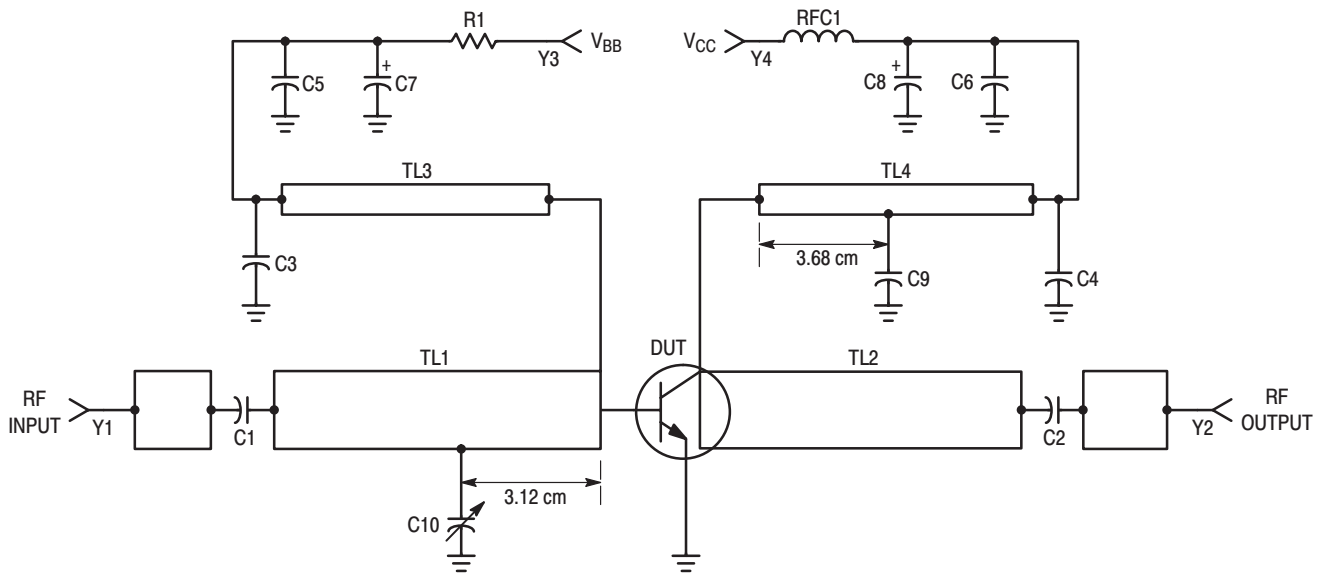

- C1, C2 — 470 pF Chip (Ceramic)
- C3, C4 — 0.018 μF Chip Capacitor
- C5, C6 — 0.1 μF Mylar
- C7, C8 — 1.0 μF, 25 Vdc Electrolytic
- C9 — 91 pF Mini-Unelco (C9 Taped 3.68 cm from Collector Connection on TL4 as shown)
- C10 — 35–45 pF Johanson Ceramic Capacitor, JMC 5801 or Equivalent (C10 Taped 3.12 cm from Base Connection on TL1)
- R1 — 2.7 kΩ, 1-1/2 W
- RFC1 — 0.15 μH Molded Choke
- TL1, TL2 — Z<sub>0</sub> = 26 Ω, 0.0625 TFG as shown in Photomaster
- TL3, TL4 — λ/4 Microstrip, Z<sub>0</sub> = 100 Ω
- Y1, Y2 — N-Type Connection (Female)
- Y3, Y4 — BNC-Type Connector (Female)
- Board Material — 0.0625" Thick Glass Teflon ε<sub>r</sub> = 2.5

Figure 15. Narrowband Test Fixture Schematic  
500 MHz

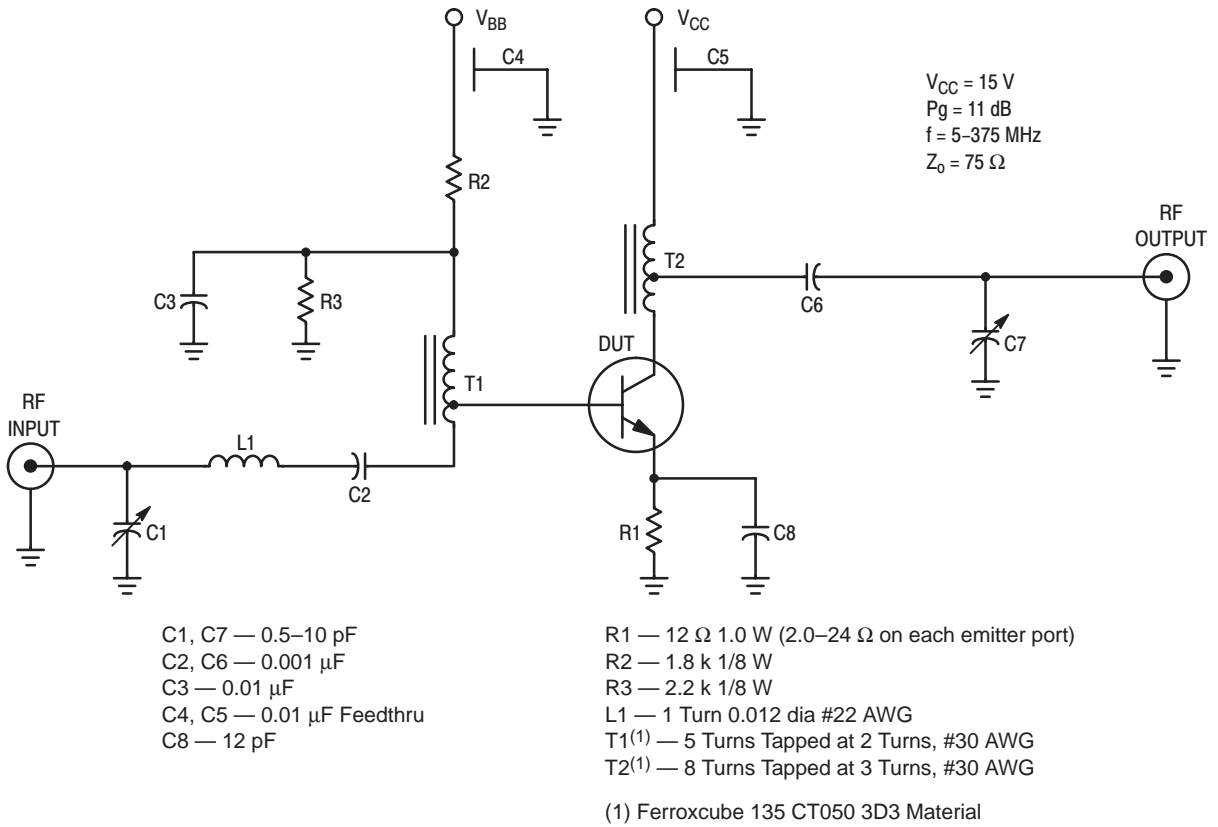

Figure 16. Broadband Test Circuit Schematic

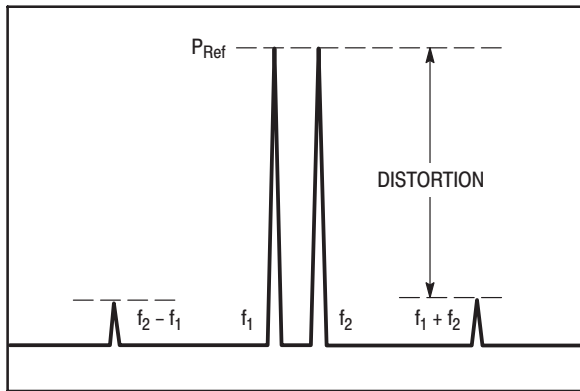

Figure 17. Second Order Distortion Test

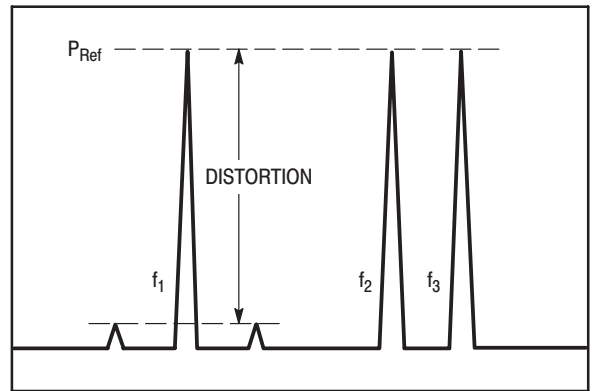

Figure 18. Triple Beat Distortion Test

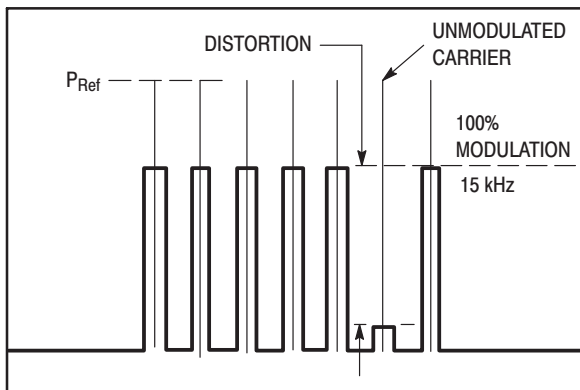

Figure 19. Cross Modulation Distortion Test

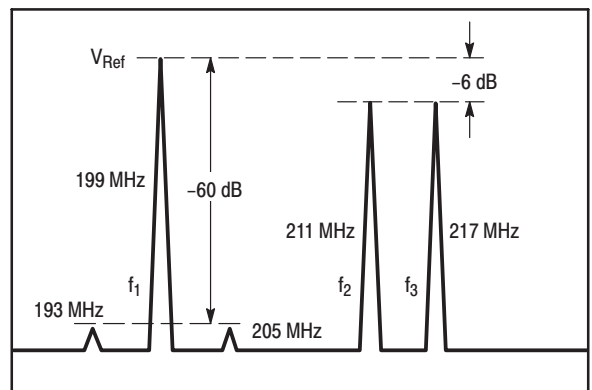
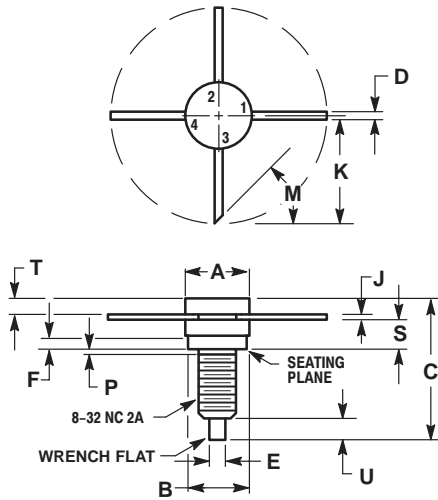

Figure 20. DIN 45004B Intermodulation Test

## PACKAGE DIMENSIONS



DIM	MILLIMETERS		INCHES	
	MIN	MAX	MIN	MAX
A	7.06	7.26	0.278	0.286
B	6.20	6.50	0.244	0.256
C	15.24	16.51	0.600	0.650
D	0.66	0.86	0.026	0.034
E	1.40	1.65	0.055	0.065
F	1.52	—	0.060	—
J	0.10	0.15	0.004	0.006
K	11.17	—	0.440	—
M	45° NOM		45° NOM	
P	—	1.27	—	0.050
S	2.74	3.35	0.108	0.132
T	1.40	1.78	0.055	0.070
U	2.92	3.68	0.115	0.145

STYLE 1:  
 PIN 1. EMITTER  
 2. BASE  
 3. EMITTER  
 4. COLLECTOR

**CASE 244A-01  
 ISSUE A**

*Specifications subject to change without notice.*

- **North America:** Tel. (800) 366-2266, Fax (800) 618-8883
- **Asia/Pacific:** Tel.+81-44-844-8296, Fax +81-44-844-8298
- **Europe:** Tel. +44 (1344) 869 595, Fax+44 (1344) 300 020

Visit [www.macom.com](http://www.macom.com) for additional data sheets and product information.

REV 6

**tyco** / Electronics

**MACOM**