

Silicon Double Balanced HMIC™ Mixer, 3000 - 4000 MHz

MA4EX370H-1225

Features

- Low Cost Miniature Plastic Package
- 6.8 dB Typical Conversion Loss
- +13 to +17 dBm LO Drive
- HMIC™ IC Process
- Silicon High Barrier Schottky Diodes
- DC - 1050 MHz IF Bandwidth

Description

M/A-COM's MA4EX370H-1225 is a silicon monolithic 3.0-4.0 GHz double balanced mixer in a low cost miniature surface mount SOT-25 package. The die uses M/A-COM's unique HMIC™ silicon/glass process to achieve low loss passive elements while retaining the advantages of high barrier silicon Schottky diodes.

Applications

These mixers are well suited for high volume WLL and WLAN applications where small size and repeatability are required. Typical applications include frequency conversion, modulation, and demodulation in wireless receivers and transmitters.

Absolute Maximum Ratings¹

Parameter	Maximum Ratings
Operating Temperature	-40 °C to +85 °C
Storage Temperature	-65 °C to +150 °C
Incident LO Power	+20 dBm
Incident RF Power	+20 dBm

1. Exceeding these limits may cause permanent damage.

Package Outline

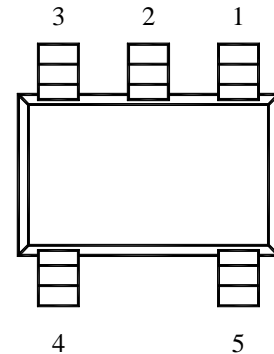

PIN Configuration

PIN	Function	PIN	Function
1	RF	4	GND
2	GND	5	IF
3	LO		

Functional Schematic

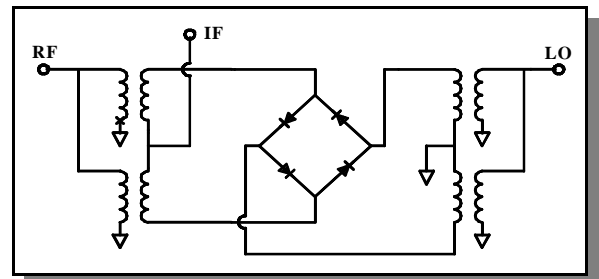

Electrical Specifications: @ + 25 °C

Parameter	Frequency Range	Test Conditions	Units	Min.	Typ.	Max.
Conversion Loss	3500 MHz 3.0-4.0 GHz	LO Drive = +15 dBm RF = -10 dBm, IF = 60 MHz	dB		6.8 6.8	8.5 9.0
L - R Isolation	3500 MHz 3.0-4.0 GHz	LO Drive = +15 dBm RF Level = -10 dBm	dB		27.5 26.0	
L - I Isolation	3500 MHz 3.0-4.0 GHz	LO Drive = +15 dBm RF Level = -10 dBm	dB		29.0 27.0	
R - I Isolation	3500 MHz 3.0-4.0 GHz	LO Drive = +15 dBm RF Level = -10 dBm	dB		11.0 12.0	
RF VSWR	3500 MHz 3.0-4.0 GHz	LO Drive = +15 dBm RF Level = -10 dBm			1.25 2.0	
IF VSWR	DC - 500 MHz	LO Drive = +15 dBm RF Level = -10 dBm			2.0	
Input IP3	3500 MHz 3.0-4.0 GHz	LO Drive = +15 dBm RF = -10 dBm, IF = 60 MHz	dBm		12.5 13.5	
Input 1 dB Compression	3500 MHz 3.0-4.0 GHz	LO Drive = +15 dBm RF = -10 dBm, IF = 60 MHz	dBm		8.0 8.5	
IF 1 dB Bandwidth	DC - 500 MHz	LO = 3650 MHz @ +15 dBm	MHz			1050

M/A-COM Inc. and its affiliates reserve the right to make changes to the product(s) or information contained herein without notice. MA-COM makes no warranty, representation or guarantee regarding the suitability of its products for any particular purpose, nor does M/A-COM assume any liability whatsoever arising out of the use or application of any product(s) or information.

Visit www.macom.com for additional data sheets and product information.

- North America: Tel. (800) 366-2266 2
- Asia/Pacific: Tel.+81-44-844-8296, Fax +81-44-844-8298
- Europe: Tel. +44 (1344) 869 595, Fax+44 (1344) 300 020

tyco / Electronics

M/A-COM

Typical Performance Curves (LO Drive = +15 dBm, RF = -10 dBm, IF = 60 MHz)

Conversion Loss

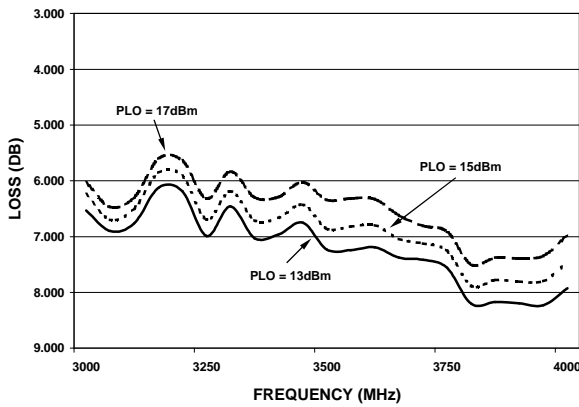

Isolation

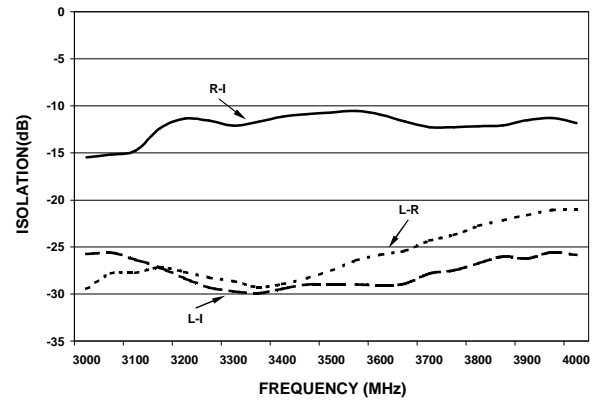

VSWR

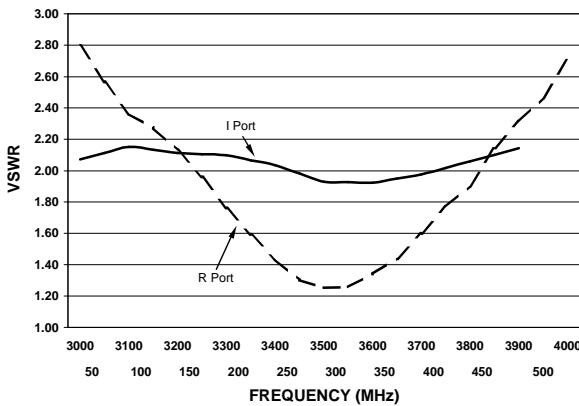

Input IP3 & 1 dB Compression Point

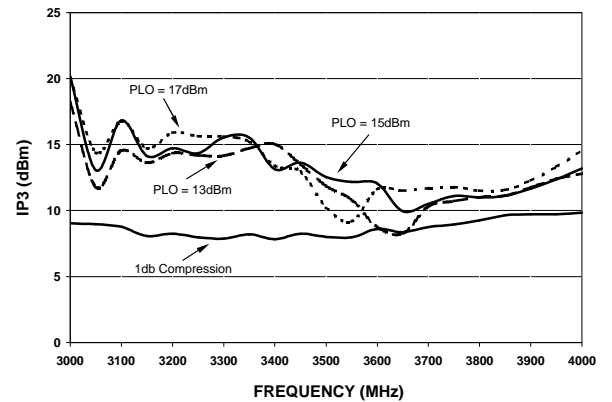

M/A-COM Inc. and its affiliates reserve the right to make changes to the product(s) or information contained herein without notice. MA-COM makes no warranty, representation or guarantee regarding the suitability of its products for any particular purpose, nor does M/A-COM assume any liability whatsoever arising out of the use or application of any product(s) or information.

Visit www.macom.com for additional data sheets and product information.

- North America: Tel. (800) 366-2266
- Asia/Pacific: Tel. +81-44-844-8296, Fax +81-44-844-8298
- Europe: Tel. +44 (1344) 869 595, Fax +44 (1344) 300 020

Case Style - SOT-25

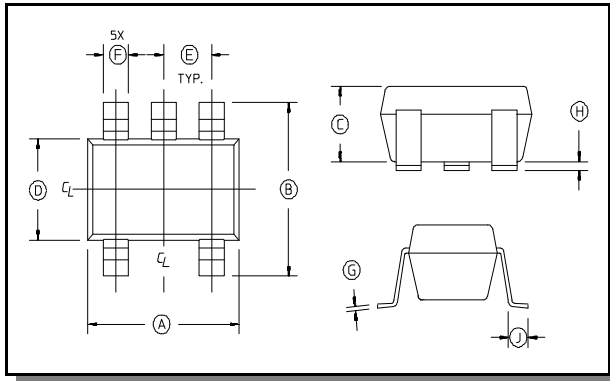

SOT-25 Dimensions

Dim	Inches		Millimeters	
	Min.	Max.	Min.	Max.
A	.106	.122	2.70	3.10
B	.100	.118	2.54	3.00
C	—	.051	—	1.30
D	.063 REF.		1.60 REF.	
E	.032	.043	.80	1.10
F	.014	.020	.35	.50
G	.003	—	.08	—
H	.000	.006	.00	.15
J	.018 REF.		.45 REF.	

Notes: 1. Leads Coplanarity should be 0.003 (0.08) max.

Ordering Information

Part Number	Package
MA4EX370H-1225	Tube
MA4EX370H-1225T	Tape and Reel

M/A-COM Inc. and its affiliates reserve the right to make changes to the product(s) or information contained herein without notice. MA-COM makes no warranty, representation or guarantee regarding the suitability of its products for any particular purpose, nor does M/A-COM assume any liability whatsoever arising out of the use or application of any product(s) or information.

Visit www.macom.com for additional data sheets and product information.

- North America: Tel. (800) 366-2266
- Asia/Pacific: Tel.+81-44-844-8296, Fax +81-44-844-8298
- Europe: Tel. +44 (1344) 869 595, Fax+44 (1344) 300 020