

M/A-COM 3.3V 0.5W RF Power Amplifier IC for DECT

Applications

- DECT
- PCS
- Personal Wireless Telephony (PWT)
- Cordless PBX
- Radio/Wireless Local Loop (RLL/WLL)

Features

- Single Positive Supply
- 16 Pin TSSOP Plastic Package
- Class AB Bias
- 1700 to 2200 MHz Operation
- 50 Ω Input Impedance
- Simple Output Match
- Accommodates Battery Charging Conditions up to 5 Volts
- Self-Aligned MSAG®-Lite MESFET Process
- Guaranteed Stability and Ruggedness

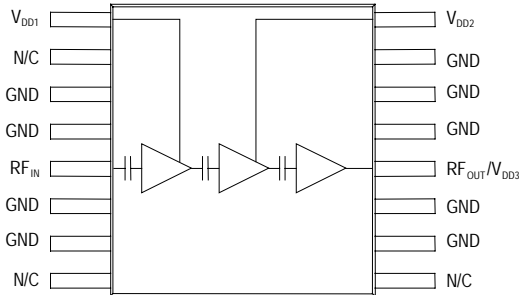

Typical 3.3 Volt Performance

- 27 dBm Output Power
- 32 dB Power Gain
- 42% Power Added Efficiency
- 40 dBc 2nd Harmonic
- 45 dBc 3rd Harmonic

ELECTRICAL CHARACTERISTICS V_{DD}= 3.3 V, P_{IN}= -5 dBm, T_S=55 °C (Note 1), Output externally matched to 50 Ω

Characteristic	Symbol	Min	Typ	Max	Unit
Frequency Range	f	1880	1905	1930	MHz
Output Power	P_{OUT}	26	27	28	dB
Power Gain	G_P	31	32	33	dB
Power Added Efficiency	η	38	42	—	%
Drain Current	I_{DD}	—	360	470	mA
Harmonics	$2f_o$	—	-40	-34	dBc
	$3f_o$	—	-45	-38	dBc
Input VSWR	—	—	1.3:1	2.0:1	—
Off Isolation (V _{DD} =0 V)	—	35	40	—	dB
Thermal Resistance (Junction of 3 rd stage FET to solder point of pin 13)	$R_{TH J-S}$	—	—	60	°C/W
Load Mismatch (V _{DD} = 5 V, VSWR = 6:1, P _{IN} = +5 dBm)	—	No Degradation in Power Output			
Stability (P _{IN} = -6 to +5 dBm, V _{DD} = 0-5 V, T _S = -40 to +85 °C, Load VSWR = 6:1)	—	All non-harmonically related outputs more than 60 dB below desired signal			

Note 1: T_s is the temperature measured at the soldering point of pin 13, mounted on 60 mil GETEK evaluation board in a free air condition with ambient room temperature T_A=25°C. The electrical data presented herein was taken with the evaluation board shown in Figures 1 & 6, under room temperature conditions, operating at 500 mW of load power (V_{DD} = 3.3 V), unless otherwise specified.

Specifications subject to change without notice.

901642 K

- North America: Tel. (800)366-2266, Fax (800)618-8883
- Asia/Pacific: Tel. +81-44-844-8296, Fax +81-44-844-8298
- Europe: Tel. +44 (1344) 869 595, Fax +44 (1344) 300 020

Visit www.macom.com for additional data sheets and product information



MAXIMUM RATINGS ($T_A = 25\text{ }^\circ\text{C}$ unless otherwise noted)

Rating	Symbol	Value	Unit
DC Supply Voltage (Pins 1, 12, 16)	V_{DD}	5	Vdc
RF Input Power	P_{IN}	3	mW
Junction Temperature	T_J	150	$^\circ\text{C}$
Storage Temperature Range	T_{STG}	-40 to +150	$^\circ\text{C}$

APPLICATION INFORMATION

Figure 1. Evaluation Board Schematic

List of components:

- C1 = 0.1 μF Kemet multilayer ceramic chip capacitor (C1206C104K5RAC)
- C2 = 4700 pF Kemet multilayer ceramic chip capacitor (C0805C472K5RAC)
- C3 = 6.2 pF DLI multilayer ceramic chip capacitor (C11AH6R2B5TXL)
- C4 = 2 pF DLI multilayer ceramic chip capacitor (C11AH2R0B5TXL)
- L1 = 39 nH Coilcraft chip inductor (1008CS.390XMBB)
- T1 = 0.10" of 50 Ω grounded coplanar waveguide (60 mil GETEK board)
- T2 = 0.07" of 50 Ω grounded coplanar waveguide (60 mil GETEK board)

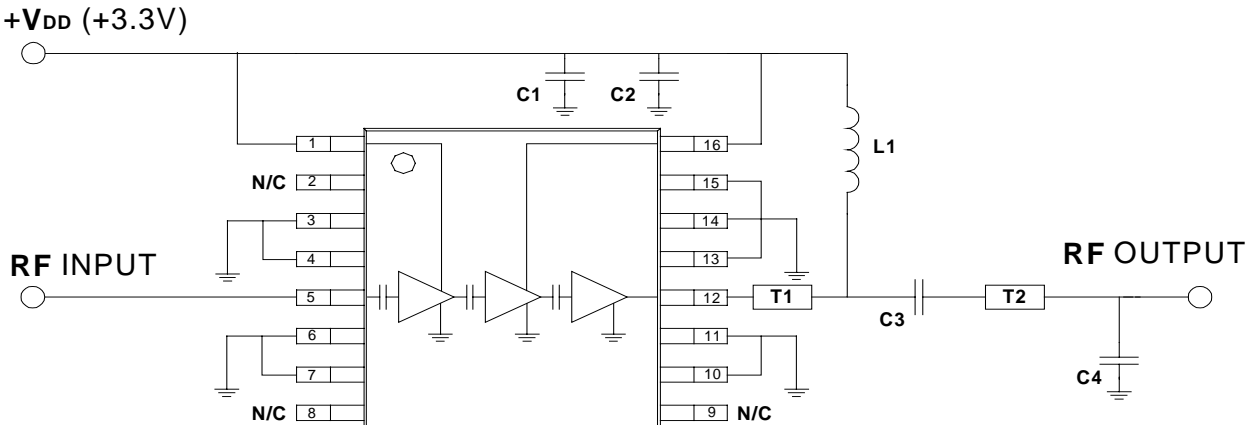

Component layout and printed circuit board drawing for RF IC evaluation board are shown in Figure 6.

Specifications subject to change without notice.

- North America: Tel. (800)366-2266, Fax (800)618-8883
- Asia/Pacific: Tel. +81-44-844-8296, Fax +81-44-844-8298
- Europe: Tel. +44 (1344) 869 595, Fax +44 (1344) 300 020

901642 K

tyco / Electronics / **M/A-COM**

Visit www.macom.com for additional data sheets and product information

TYPICAL CHARACTERISTICS

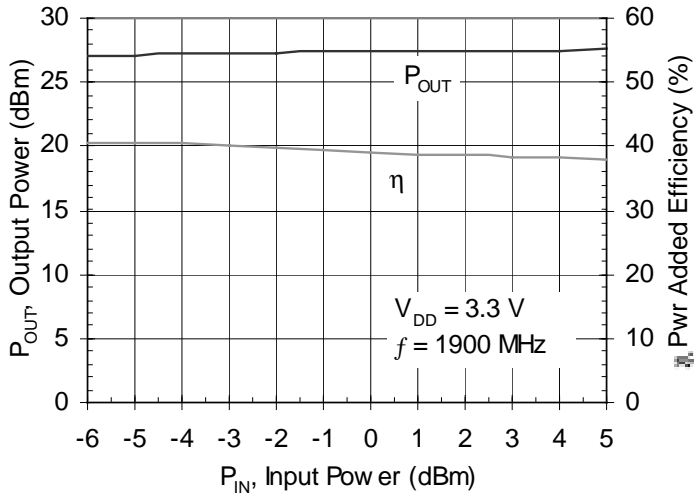

Figure 2. Output power and efficiency vs. input power

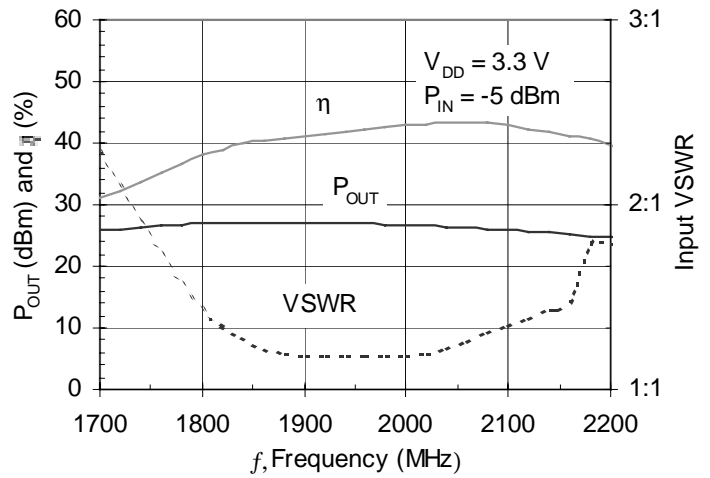

Figure 3. Output power, efficiency and input VSWR vs. frequency

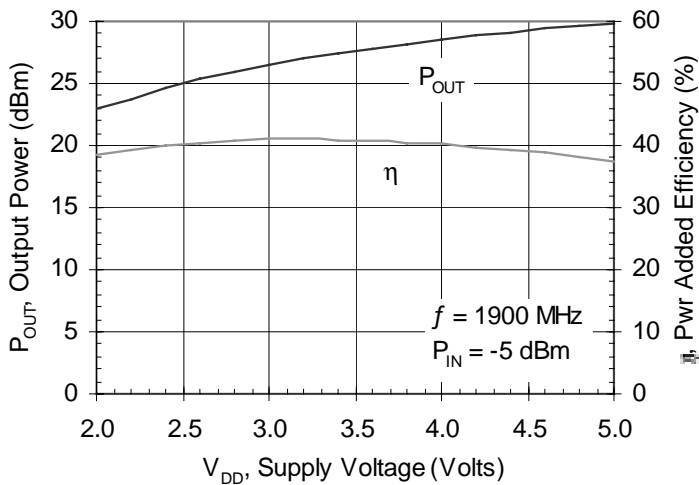

Figure 4. Output power and efficiency vs. supply voltage

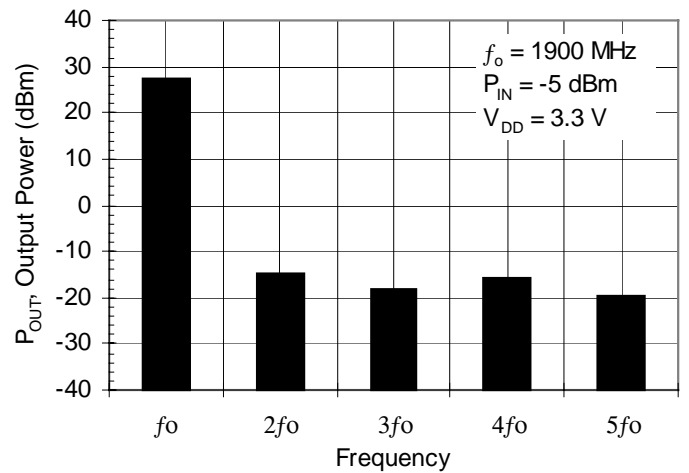

Figure 5. Harmonics

Specifications subject to change without notice.

- North America: Tel. (800)366-2266, Fax (800)618-8883
- Asia/Pacific: Tel. +81-44-844-8296, Fax +81-44-844-8298
- Europe: Tel. +44 (1344) 869 595, Fax +44 (1344) 300 020

901642 K

Visit www.macom.com for additional data sheets and product information

MECHANICAL DATA

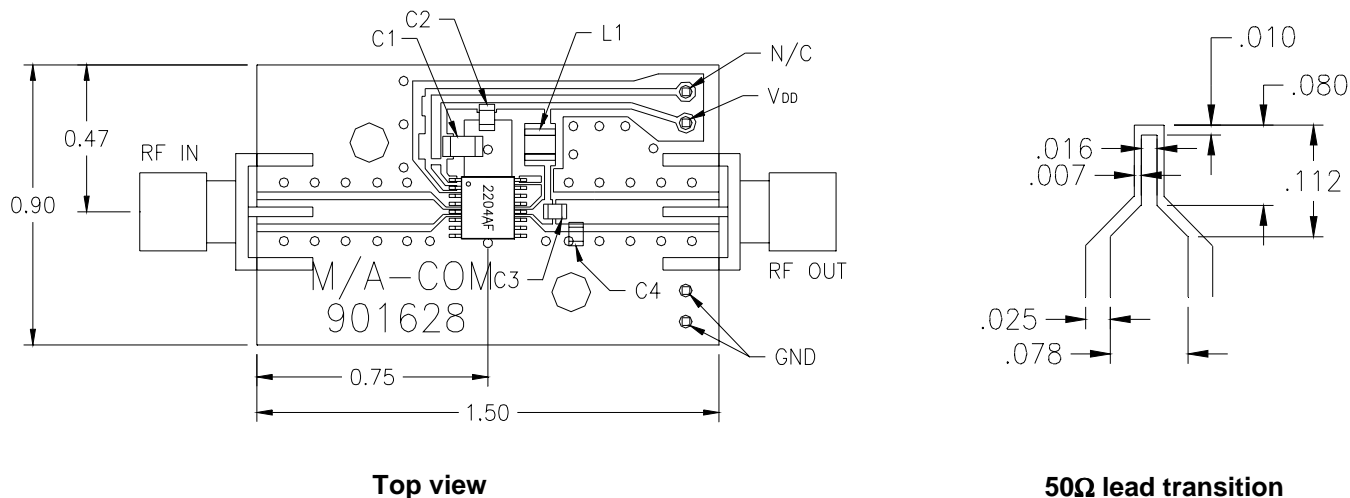

Figure 6. Component layout and printed circuit drawing for evaluation board

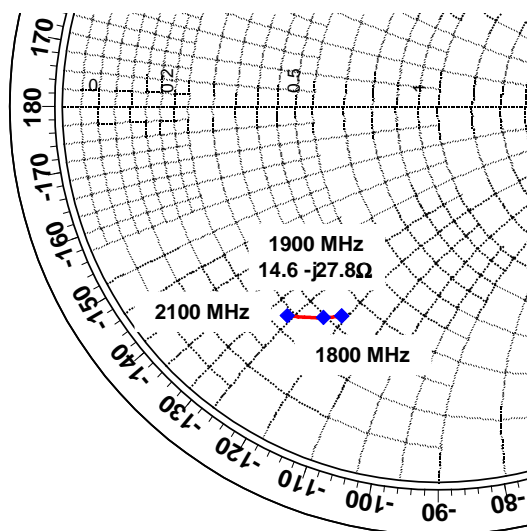

Figure 7. Output match impedance (as seen from pin 12)

Specifications subject to change without notice.

- North America: Tel. (800)366-2266, Fax (800)618-8883
- Asia/Pacific: Tel. +81-44-844-8296, Fax +81-44-844-8298
- Europe: Tel. +44 (1344) 869 595, Fax +44 (1344) 300 020

901642 K

Visit www.macom.com for additional data sheets and product information

