



# Monolithic PIN Diode Switches



## Features

- Broad Bandwidth
  - Specified up to 20 GHz
  - Usable to 26.5 GHz
- Low Insertion Loss / High Isolation
- Rugged, Fully Monolithic, Glass Encapsulated Construction

## Description

The MA4SW110, 210 and 310 series are broad band monolithic switches using series and shunt connected silicon PIN diodes. They are designed for use as small signal, high performance switches in applications up to 26.5 GHz. They provide performance levels superior to those realized by hybrid MIC designs incorporating beam lead and PIN chip diodes that require chip and wire assembly.

These switches are fabricated using M/A-COM's patented HMIC™ (Heterolithic Microwave Integrated Circuit) process, US Patent 5,268,310. This process allows the incorporation of silicon pedestals that form series and shunt diodes or vias by imbedding them in low loss glass. By using small spacing between elements, this combination of silicon and glass gives HMIC devices low loss and high isolation performance through low millimeter frequencies.

Large bond pads facilitate the use of low inductance ribbon leads, while gold backside metalization allows for manual or automatic chip bonding via 80/20 AuSn solder or conductive epoxy.

## Absolute Maximum Rating<sup>1</sup>

| Parameter                 | Absolute Maximum |
|---------------------------|------------------|
| Operating Temperature     | -65°C to +125°C  |
| Storage Temperature       | -65°C to +150°C  |
| Applied Voltage (Reverse) | 50 volts         |
| RF Incident Power         | +30 dBm          |
| Bias Current              | 50 mA            |

1. Exceeding these limits may cause permanent damage.

MA4SW110

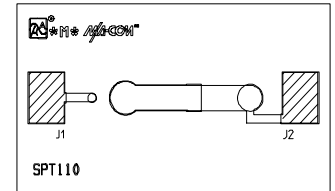
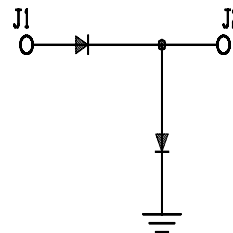

MA4SW210

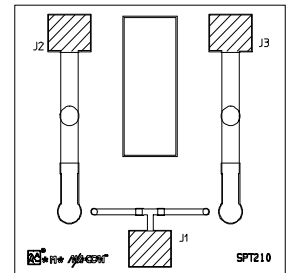
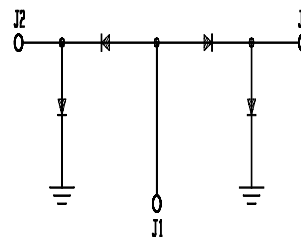

MA4SW310

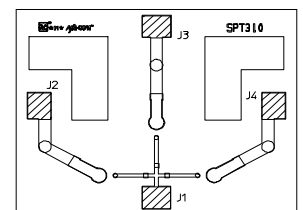
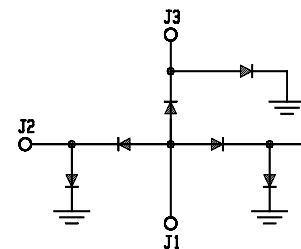

**MA4SW110 (SPST)****Electrical Specifications @  $T_A = +25^\circ\text{C}$ , +/- 20 mA Bias Current**

| Parameter                    | Frequency | Minimum | Nominal | Maximum | Units |
|------------------------------|-----------|---------|---------|---------|-------|
| Insertion Loss               | 6 GHz     | -       | 0.4     | 0.7     | dB    |
|                              | 13 GHz    | -       | 0.5     | 0.9     | dB    |
|                              | 20 GHz    | -       | 0.7     | 1.2     | dB    |
| Isolation                    | 6 GHz     | 46      | 55      | -       | dB    |
|                              | 13 GHz    | 39      | 47      | -       | dB    |
|                              | 20 GHz    | 34      | 42      | -       | dB    |
| Input Return Loss            | 6 GHz     | 22      | 31      | -       | dB    |
|                              | 13 GHz    | 15      | 33      | -       | dB    |
|                              | 20 GHz    | 14      | 27      | -       | dB    |
| Switching Speed <sup>1</sup> | -         | -       | 20      | -       | ns    |
| Voltage Rating <sup>2</sup>  | -         | -       | -       | 50      | V     |
| Signal Compression @ 500mW   | 1GHz      | -       | 0.2     | -       | dB    |

**MA4SW210 (SPDT)****Electrical Specifications @  $T_A = +25^\circ\text{C}$ , +/- 20 mA Bias Current**

| Parameter                    | Frequency | Minimum | Nominal | Maximum | Units |
|------------------------------|-----------|---------|---------|---------|-------|
| Insertion Loss               | 6 GHz     | -       | 0.4     | 0.7     | dB    |
|                              | 13 GHz    | -       | 0.5     | 1.0     | dB    |
|                              | 20 GHz    | -       | 0.7     | 1.2     | dB    |
| Isolation                    | 6 GHz     | 48      | 63      | -       | dB    |
|                              | 13 GHz    | 40      | 50      | -       | dB    |
|                              | 20 GHz    | 34      | 42      | -       | dB    |
| Input Return Loss            | 6 GHz     | 20      | 27      | -       | dB    |
|                              | 13 GHz    | 18      | 25      | -       | dB    |
|                              | 20 GHz    | 15      | 25      | -       | dB    |
| Switching Speed <sup>1</sup> | -         | -       | 20      | -       | ns    |
| Voltage Rating <sup>2</sup>  | -         | -       | -       | 50      | V     |
| Signal Compression @ 500mW   | 1 GHz     | -       | 0.2     | -       | dB    |

**MA4SW310 (SP3T)****Electrical Specifications @  $T_A = +25^\circ\text{C}$ , +/- 20 mA Bias Current**

| Parameter                    | Frequency | Minimum | Nominal | Maximum | Units |
|------------------------------|-----------|---------|---------|---------|-------|
| Insertion Loss               | 6 GHz     | -       | 0.5     | 0.8     | dB    |
|                              | 13 GHz    | -       | 0.7     | 1.1     | dB    |
|                              | 20 GHz    | -       | 0.9     | 1.5     | dB    |
| Isolation                    | 6 GHz     | 49      | 57      | -       | dB    |
|                              | 13 GHz    | 42      | 48      | -       | dB    |
|                              | 20 GHz    | 33      | 42      | -       | dB    |
| Input Return Loss            | 6 GHz     | 20      | 24      | -       | dB    |
|                              | 13 GHz    | 14      | 22      | -       | dB    |
|                              | 20 GHz    | 11      | 21      | -       | dB    |
| Switching Speed <sup>1</sup> | -         | -       | 20      | -       | ns    |
| Voltage Rating <sup>2</sup>  | -         | -       | -       | 50      | V     |
| Signal Compression @ 500mW   | 1 GHz     | -       | 0.2     | -       | dB    |

1 Typical Switching Speed measured from 10 % to 90 % of detected RF signal driven by TTL compatible drivers.

2 The Reverse Current in the shunt or series PIN diode shall be 10 $\mu$ A maximum at 50 volts reverse voltage.

V4.00

Typical Performance Curves @  $T_A = +25^\circ\text{C}$ , +/- 20mA Bias Current

MA4SW110 Return Loss vs Frequency

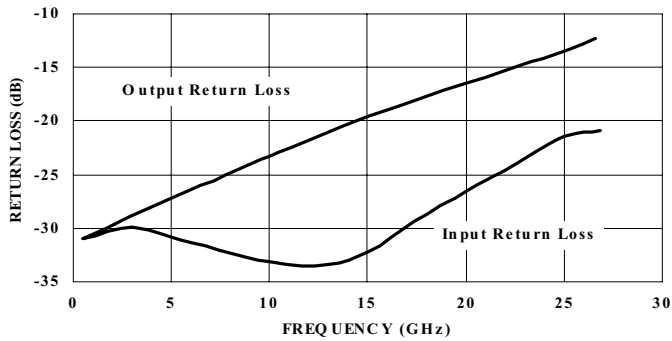

MA4SW210 Return Loss vs. Frequency

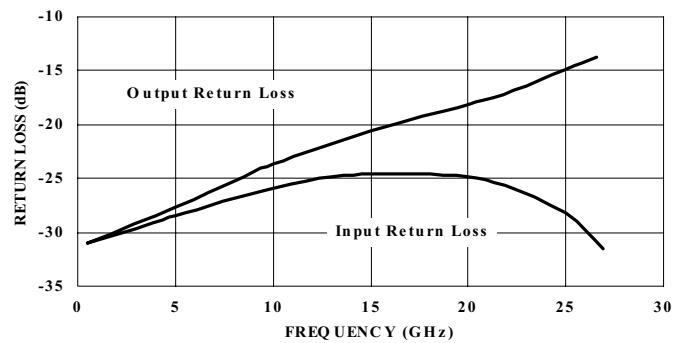

MA4SW310 Return Loss vs Frequency

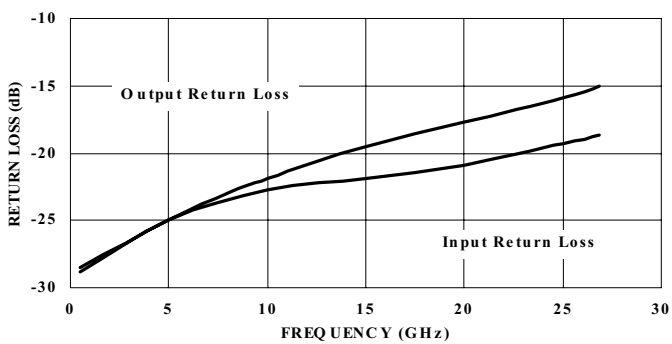

MA4SW110 Insertion Loss vs Frequency

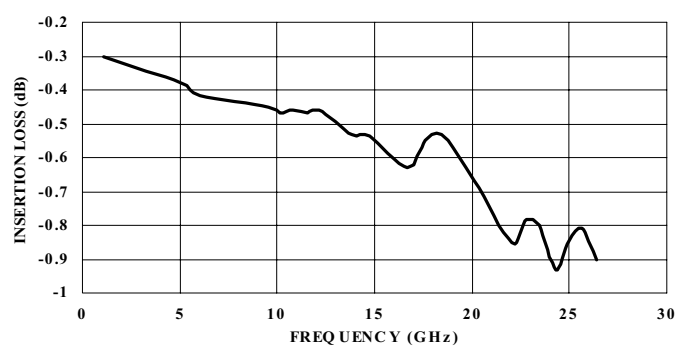

MA4SW210 Insertion Loss vs Frequency

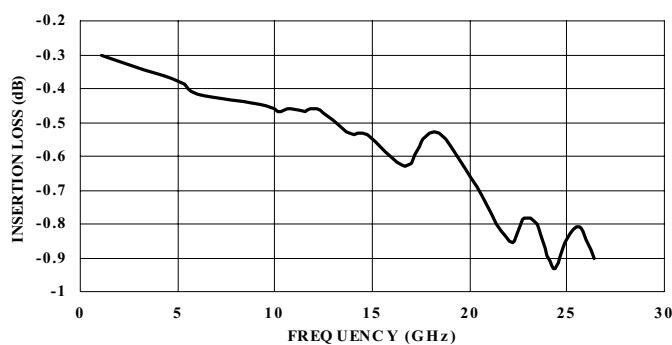

MA4SW310 Insertion Loss vs Frequency

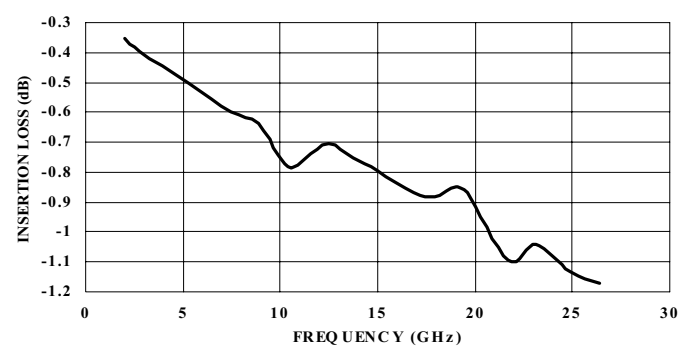

**S-Parameters:** Touchstone files containing S-Parameter data for these devices are available upon request.

Typical Performance Curves @  $T_A = +25^\circ\text{C}$ , +/- 20mA Bias Current

MA4SW110 Isolation vs Frequency

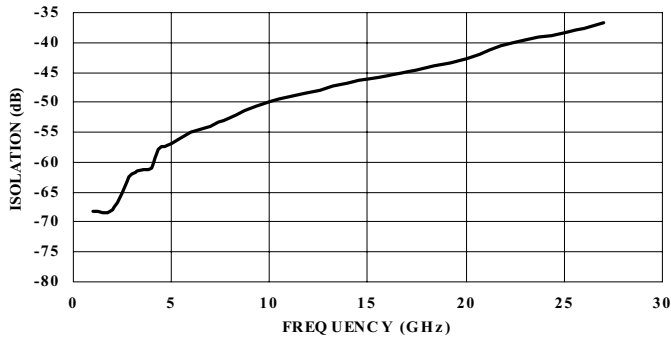

MA4SW210 Isolation vs Frequency

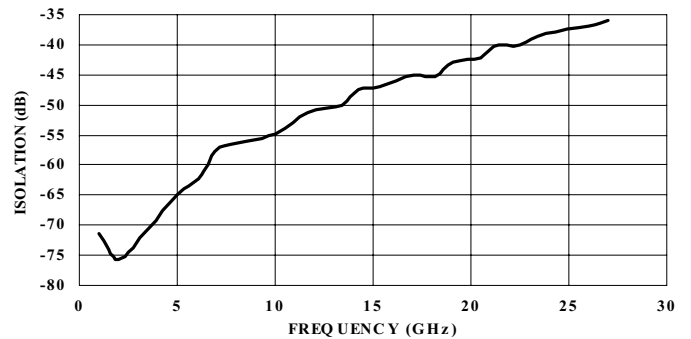

MA4SW310 Isolation vs Frequency

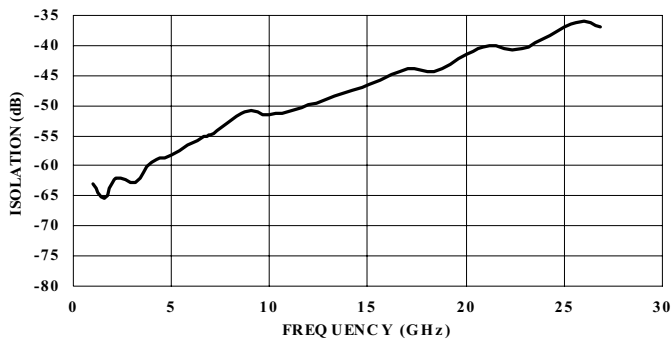

Input Return Loss vs Bias Current @ 10 GHz

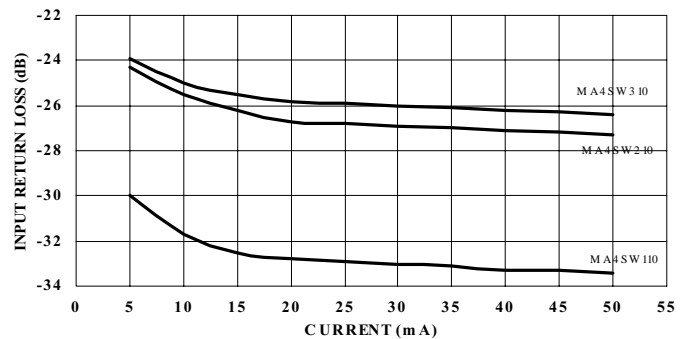

Insertion Loss vs Bias Current @ 10 GHz

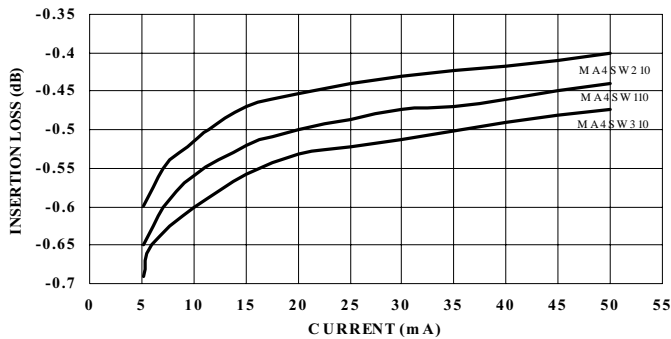

Output Return Loss vs Bias Current @ 10 GHz

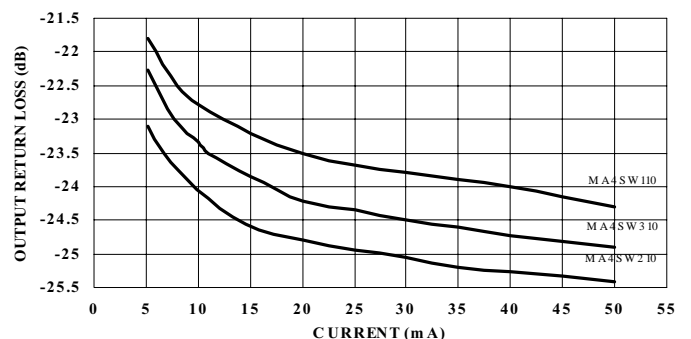

Isolation vs Bias Current @ 10 GHz

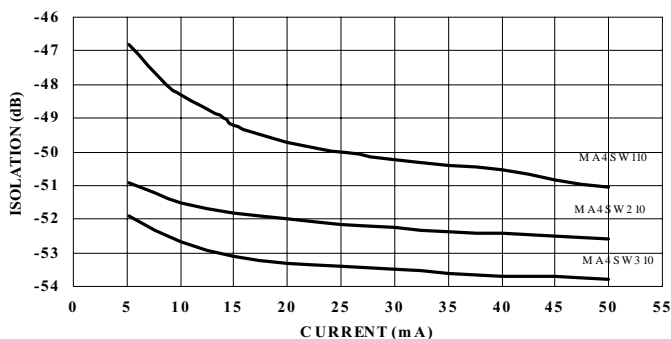

**Operation of the MA4SW Series**

Operation of the MA4SW series of PIN Switches is achieved by simultaneous application of negative DC current to the low loss switching arm J1, J2, or J3, and positive DC current to the remaining switching arms as shown in the Bias Connection circuits. DC return is achieved via J1. The control currents should be supplied by constant current sources. The voltages at these points will not exceed + 1.5 volts (1.2 volts typical) at currents up to + 50 mA. In the Low Loss state, the series diode must be forward biased and the shunt diode reverse biased. In the isolated arm, the shunt diode is forward biased and the series diode is reverse biased.

**MA4SW110 and Bias Connections <sup>1</sup>**

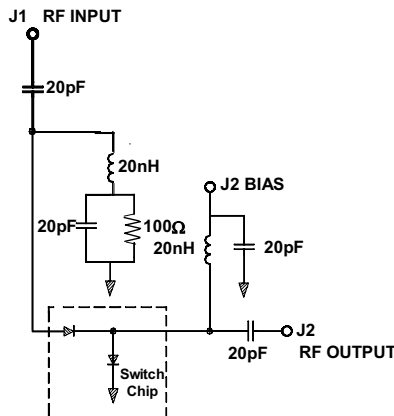

**Driver Connections**

**MA4SW110**

| Control Level (DC Current) at | Condition of RF Output |
|-------------------------------|------------------------|
| J2                            | J1-J2                  |
| -20 mA                        | Low Loss               |
| +20 mA                        | Isolation              |

**MA4SW210 and Bias Connections <sup>1</sup>**

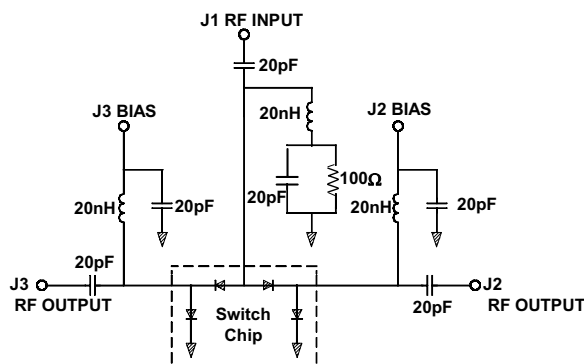

**MA4SW210**

| Control Level (DC Current) at |        | Condition of RF Output | Condition of RF Output |
|-------------------------------|--------|------------------------|------------------------|
| J2                            | J3     | J1-J2                  | J1-J3                  |
| -20 mA                        | +20 mA | Low Loss               | Isolation              |
| +20 mA                        | -20 mA | Isolation              | Low Loss               |

**MA4SW310**

| Control Level (DC Current) at |        |        | Condition of RF Output | Condition of RF Output | Condition of RF Output |
|-------------------------------|--------|--------|------------------------|------------------------|------------------------|
| J2                            | J3     | J4     | J1-J2                  | J1-J3                  | J1-J4                  |
| -20 mA                        | +20 mA | +20 mA | Low Loss               | Isolation              | Isolation              |
| +20 mA                        | -20 mA | +20 mA | Isolation              | Low Loss               | Isolation              |
| +20 mA                        | +20 mA | -20 mA | Isolation              | Isolation              | Low Loss               |

**MA4SW310 and Bias Connections <sup>1</sup>**

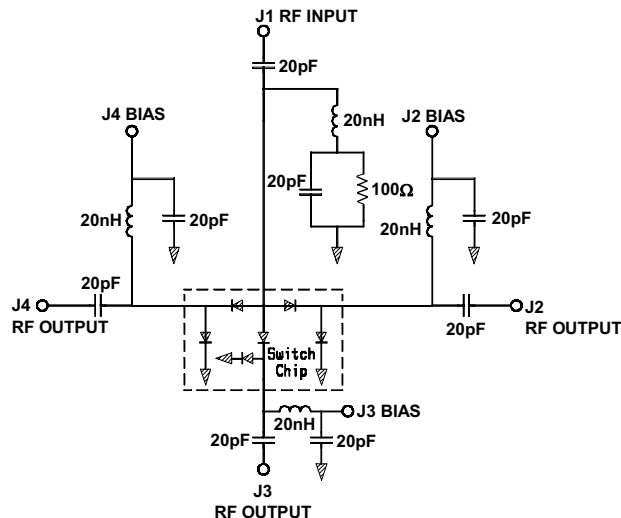

**Handling Considerations**

**Cleanliness:** These chips should be handled in a clean environment. Do not attempt to clean chips after installation.

**Electro-Static Sensitivity:** The MA4SW Series PIN switches are ESD, Class 1 sensitive. The proper ESD handling procedures should be used.

Notes:

1. RLC values are for a typical operating frequency of 2 - 18 GHz and Bias Current of ± 20mA per diode.

**Wire Bonding**

Thermosonic wedge wire bonding using 0.003” x 0.00025” ribbon or 0.001” diameter gold wire is recommended. A stage temperature of 150 °C and a force of 18 to 22 grams should be used. Ultrasonic energy should be adjusted to the minimum required. RF bonds should be as short as possible.

**Mounting**

These chips have TiPtAu back metal. They can be die mounted with a gold-tin eutectic solder preform or conductive epoxy. Mounting surface must be clean and flat.

**Eutectic Die Attachment:** An 80/20 gold-tin eutectic solder preform is recommended with a work surface temperature of 255 °C and a tool tip temperature of 265°C. When hot gas is applied, the tool tip temperature should be 290 °C. The chip should not be exposed to temperatures greater than 320 °C for more than 20 seconds. No more than three seconds should be required for attachment.

**Epoxy Die Attachment:** Assembly should be preheated to 125-150 °C. A minimum amount of epoxy should be used. A thin epoxy fillet should be visible around the perimeter of the chip after placement. Cure epoxy per manufacturer’s schedule.

**Chip Outline Drawings<sup>1,2</sup>**

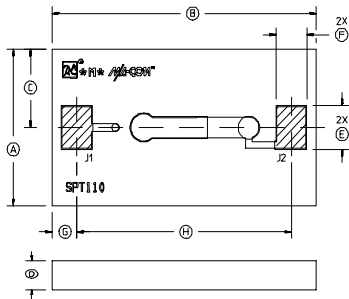

| DIM | INCHES    |       | MM       |      |
|-----|-----------|-------|----------|------|
|     | MIN.      | MAX.  | MIN.     | MAX. |
| A   | 0.014     | 0.018 | 0.35     | 0.45 |
| B   | 0.025     | 0.029 | 0.64     | 0.74 |
| C   | 0.008 REF |       | 0.20 REF |      |
| D   | 0.004     | 0.006 | 0.10     | 0.15 |
| E   | 0.004 REF |       | 0.10 REF |      |
| F   | 0.003 REF |       | 0.08 REF |      |
| G   | 0.003 REF |       | 0.08 REF |      |
| H   | 0.020 REF |       | 0.52 REF |      |

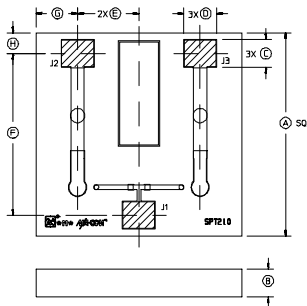

| DIM | INCHES    |       | MM       |      |
|-----|-----------|-------|----------|------|
|     | MIN.      | MAX.  | MIN.     | MAX. |
| A   | 0.029     | 0.033 | 0.73     | 0.83 |
| B   | 0.004     | 0.006 | 0.10     | 0.15 |
| C   | 0.004 REF |       | 0.10 REF |      |
| D   | 0.005 REF |       | 0.13 REF |      |
| E   | 0.009 REF |       | 0.23 REF |      |
| F   | 0.023 REF |       | 0.58 REF |      |
| G   | 0.007 REF |       | 0.17 REF |      |
| H   | 0.004 REF |       | 0.10 REF |      |

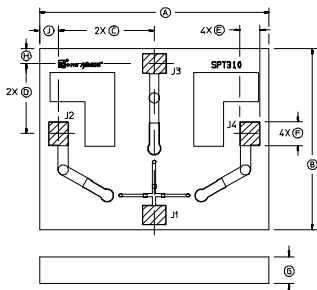

| DIM | INCHES    |       | MM       |      |
|-----|-----------|-------|----------|------|
|     | MIN.      | MAX.  | MIN.     | MAX. |
| A   | 0.046     | 0.050 | 1.16     | 1.26 |
| B   | 0.036     | 0.040 | 0.92     | 1.02 |
| C   | 0.019 REF |       | 0.48 REF |      |
| D   | 0.014 REF |       | 0.36 REF |      |
| E   | 0.004 REF |       | 0.10 REF |      |
| F   | 0.005 REF |       | 0.13 REF |      |
| G   | 0.004     | 0.006 | 0.10     | 0.15 |
| H   | 0.005 REF |       | 0.12 REF |      |
| J   | 0.004 REF |       | 0.10 REF |      |

- Notes:** 1. Topside metallization is gold 2.5µm thick typ. Backside metallization is gold. 1.0µm thick typ.  
 2. Hatched areas indicate wire bonding pads.



