

# Miniature Broadband Gain Stage

## 200 - 3000 MHz

MAALSS0012

### Features

- Low Noise Figure
- High IP<sub>3</sub>
- Single +3 V or +5 V Supply Voltage
- Very Stable Over Temperature

### Description

M/A-COM's MAALSS0012 broadband gain stage is a GaAs MMIC amplifier in a low-cost miniature SOT-363 surface mount plastic package. The MAALSS0012 employs a monolithic 1-stage self-biased design featuring a convenient 50 ohm input/output impedance that minimizes the number of external components required. The device typically runs from a single 3.0 volt supply and may also operate at any voltage up to 5.0 volts for improved power performance. Its broadband design provides usable performance from 200 to 3000 MHz.

M/A-COM fabricates the MAALSS0012 using an E/D MESFET process to realize low noise and high dynamic range. The process features full passivation for performance and reliability.

### Functional Block Diagram

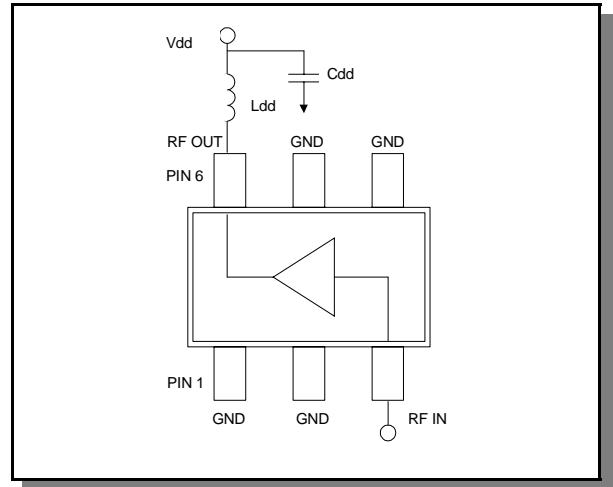

### External Circuitry

Part	Value	Purpose
C <sub>dd</sub>	470 pF	Decoupling capacitor
L <sub>dd</sub>	12 nH	RF choke

### Electrical Specifications<sup>1</sup>: T<sub>A</sub> = 25 °C

Parameter	Test Conditions	Units	+3 V			+5 V		
			Min.	Typ.	Max.	Min.	Typ.	Max.
Gain <sup>2</sup>	F = 0.9 GHz	dB	13.0	14.0	15.0	13.2	14.2	15.2
	F = 1.9 GHz	dB	10.9	11.9	12.9	11.0	12.0	13.0
	F = 3.0 GHz	dB		9.4			9.6	
Noise Figure <sup>3</sup>	F = 0.9 GHz	dB		1.4	2.0		1.5	2.0
	F = 1.9 GHz	dB		1.4	2.0		1.5	2.0
	F = 3.0 GHz	dB		1.5			1.6	
Input Return Loss	F = 0.9 GHz	dB		9.3			9.4	
	F = 1.9 GHz	dB		13.2			13.2	
	F = 3.0 GHz	dB		14.9			14.7	
Output Return Loss	F = 0.9 GHz	dB		9.0			9.7	
	F = 1.9 GHz	dB		15.2			15.5	
	F = 3.0 GHz	dB		27.0			33.0	
1dB Compression	200 – 3000 MHz	dBm		18			21	
Output IP <sub>3</sub>	200 – 3000 MHz	dBm		33			36	
Current		mA	50	79	95	65	87	100

1. All measurements taken in a 50-Ω system unless otherwise specified.

2. Gain varies at -0.0025 dB/°C typical.

3. Noise figure varies at 0.007 dB/°C typical.

### Absolute Maximum Ratings<sup>1</sup>

Parameter	Absolute Maximum
RF Input Power	15 dBm
Voltage	6.0 volts
Operating Temperature	-40 °C to +85 °C
Storage Temperature	-65 °C to +150 °C

1. Exceeding any one or combination of these limits may cause permanent damage.
2. Minimum MTTF is 1x10<sup>6</sup> at +85°C, +5V, and 100 mA.

### PIN Configuration

PIN	Function	Description
1	GND	Ground
2	GND	Ground
3	RF In	RF input
4	GND	Ground
5	GND	Ground
6 <sup>1</sup>	RF Out/V <sub>DD</sub>	RF output & drain voltage input

1. Series inductor and decoupling capacitor recommended on pin 6.

### Typical Performance Curves

S-Parameters V<sub>DD</sub> @ 2.7 V, T = 25 °C

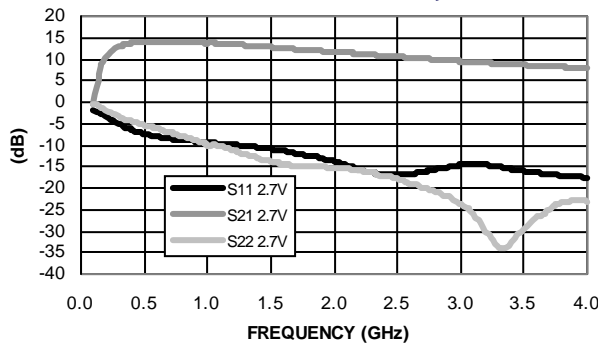

S-Parameters V<sub>DD</sub> @ 3.0 V, T = 25 °C

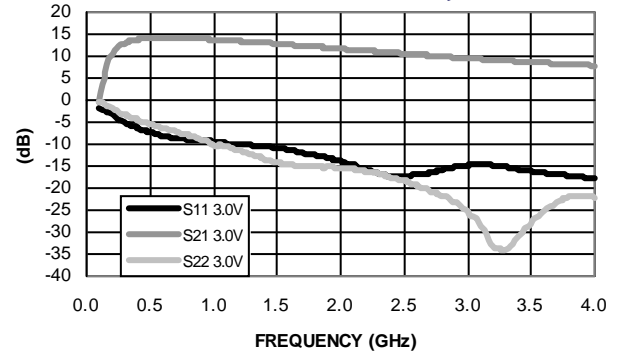

S-Parameters V<sub>DD</sub> @ 5.0 V, T = 25 °C

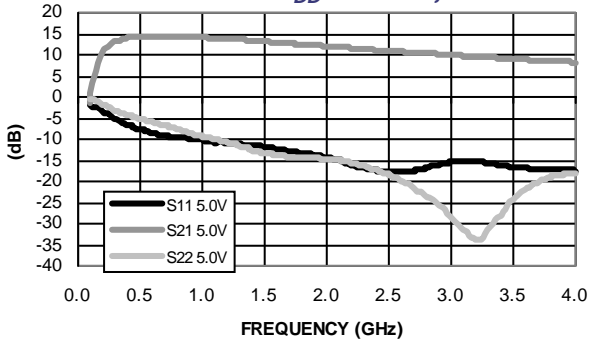

S-Parameters V<sub>DD</sub> @ 2.7 V, T = - 40 °C

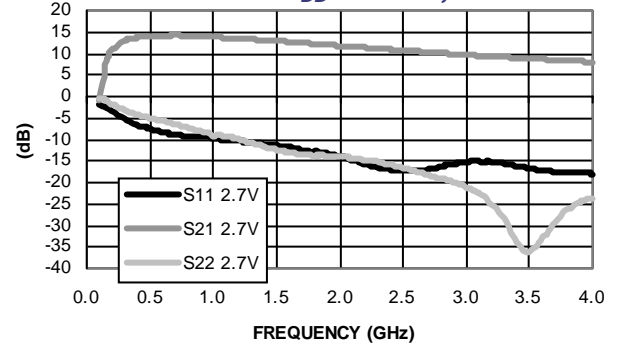

Specifications subject to change without notice.

- North America: Tel. (800) 366-2266
- Asia/Pacific: Tel.+81-44-844-8296, Fax +81-44-844-8298
- Europe: Tel. +44 (1344) 869 595, Fax+44 (1344) 300 020

Visit [www.macom.com](http://www.macom.com) for additional data sheets and product information.

Typical Performance Curves (Cont'd)

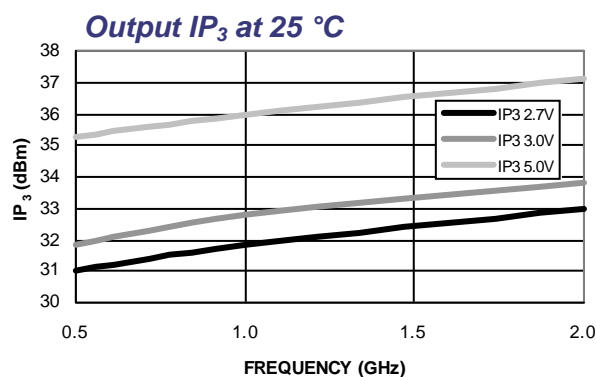
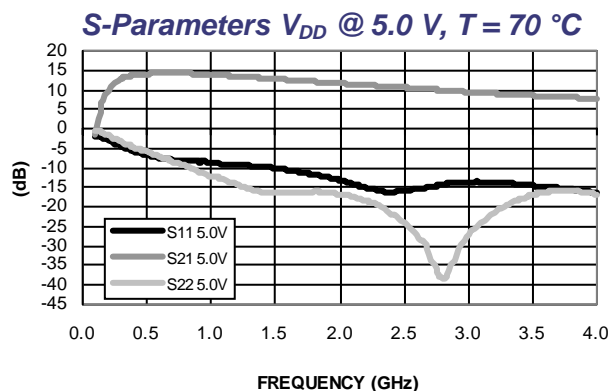
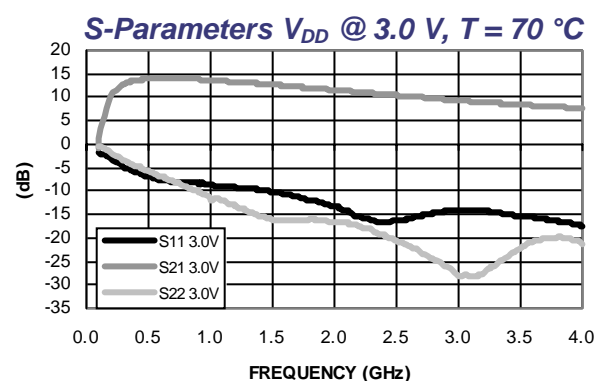
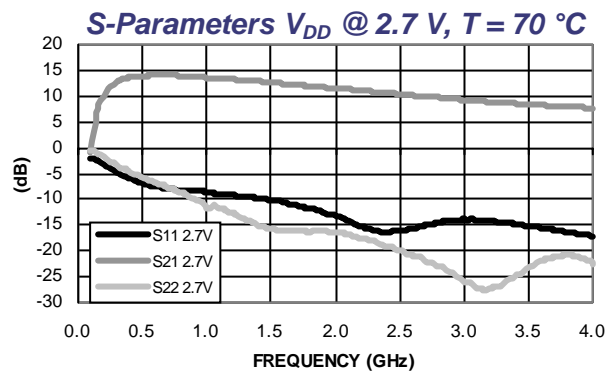
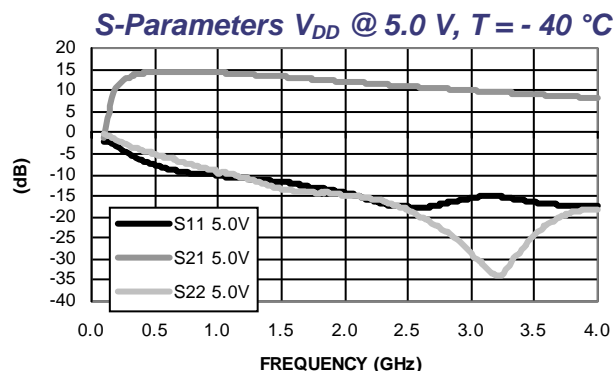
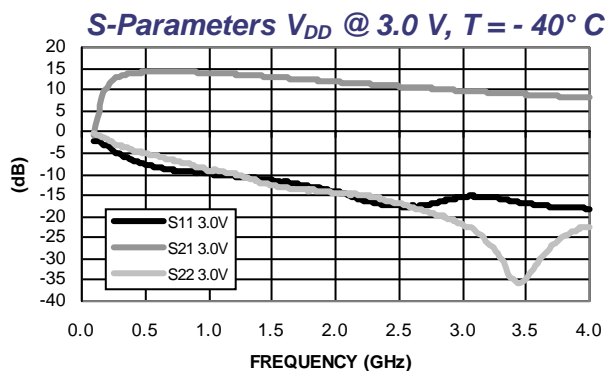

Specifications subject to change without notice.

- North America: Tel. (800) 366-2266
- Asia/Pacific: Tel.+81-44-844-8296, Fax +81-44-844-8298
- Europe: Tel. +44 (1344) 869 595, Fax+44 (1344) 300 020

Visit [www.macom.com](http://www.macom.com) for additional data sheets and product information.

Typical Performance Curves (Cont'd)

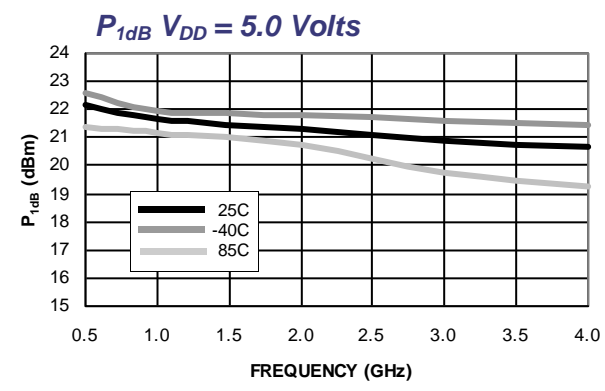
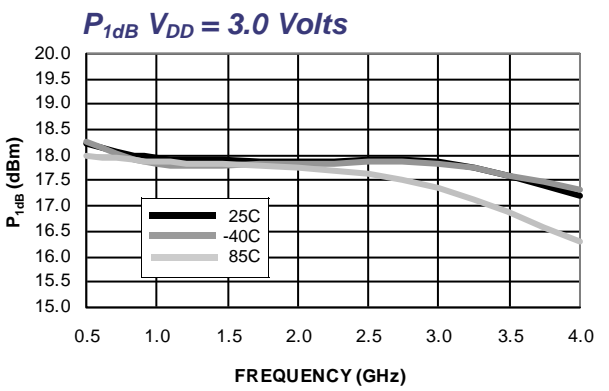
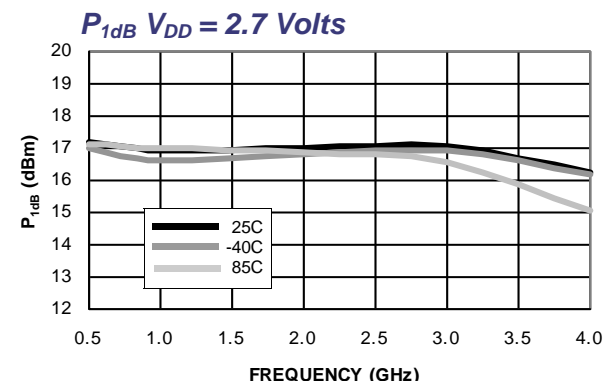
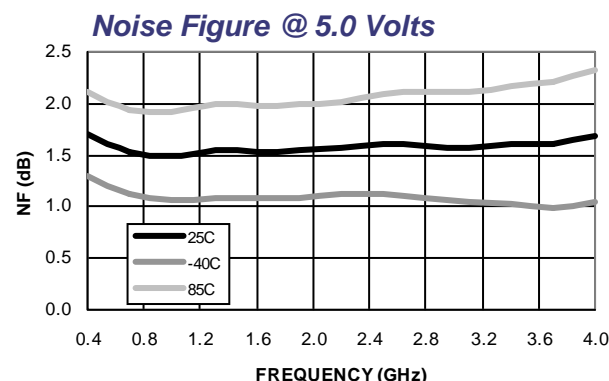
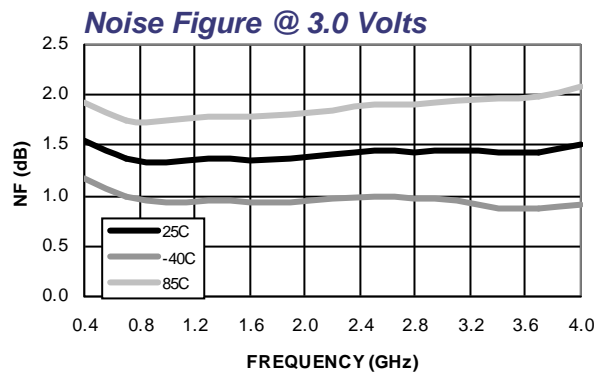
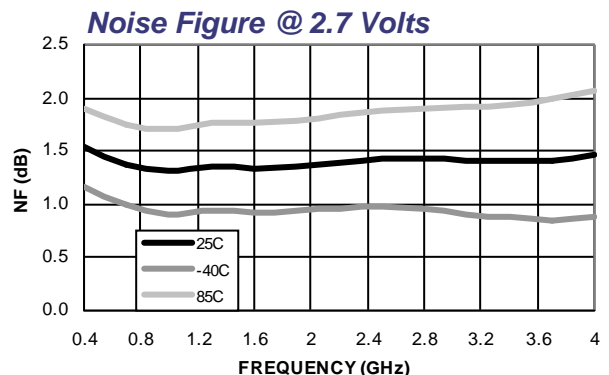

Specifications subject to change without notice.

- North America: Tel. (800) 366-2266
- Asia/Pacific: Tel.+81-44-844-8296, Fax +81-44-844-8298
- Europe: Tel. +44 (1344) 869 595, Fax+44 (1344) 300 020

Visit [www.macom.com](http://www.macom.com) for additional data sheets and product information.



## Typical S-Parameter Data: 2.7 Volts @ 80 mA

Frequency MHz	S <sub>11</sub>		S <sub>21</sub>		S <sub>12</sub>		S <sub>22</sub>	
	Mag	Ang	Mag	Ang	Mag	Ang	Mag	Ang
400.000	0.2256	-37.03	6.0729	156.17	0.0589	9.34	0.2671	165.08
504.000	0.2219	-42.93	5.9561	151.08	0.0591	10.84	0.2619	160.07
608.000	0.2226	-49.32	5.8267	146.22	0.0591	12.80	0.2526	156.14
660.000	0.2221	-52.48	5.7584	143.68	0.0592	13.54	0.2466	154.05
764.000	0.2214	-58.65	5.6232	138.86	0.0599	15.45	0.2374	149.97
868.000	0.2210	-64.80	5.4826	134.19	0.0600	17.93	0.2267	146.22
972.000	0.2197	-70.49	5.3068	129.42	0.0603	19.95	0.2148	142.03
1076.000	0.2216	-76.33	5.1677	125.01	0.0616	22.51	0.2043	139.02
1180.000	0.2224	-82.01	5.0128	120.76	0.0624	24.49	0.1926	136.09
1284.000	0.2211	-87.07	4.8508	116.57	0.0644	27.03	0.1848	132.86
1388.000	0.2231	-92.07	4.7231	112.63	0.0660	29.49	0.1743	130.63
1492.000	0.2241	-96.75	4.5778	108.93	0.0679	31.65	0.1646	128.19
1596.000	0.2252	-101.10	4.4398	105.21	0.0702	33.37	0.1556	125.64
1700.000	0.2270	-105.62	4.3034	101.69	0.0724	35.52	0.1462	124.69
1804.000	0.2292	-109.34	4.1744	98.20	0.0759	37.62	0.1375	123.32
1908.000	0.2305	-113.34	4.0432	94.87	0.0783	38.40	0.1275	122.77
2012.000	0.2310	-117.21	3.9288	91.64	0.0816	39.90	0.1223	121.44
2116.000	0.2344	-120.73	3.8106	88.45	0.0851	41.32	0.1137	121.94
2220.000	0.2358	-124.00	3.7100	85.29	0.0885	42.07	0.1068	121.71
2324.000	0.2373	-127.52	3.6114	82.27	0.0928	43.01	0.1017	121.75
2428.000	0.2393	-130.65	3.5092	79.46	0.0963	44.00	0.0976	122.79
2532.000	0.2409	-134.18	3.4345	76.78	0.1004	44.58	0.0953	124.23
2636.000	0.2433	-137.24	3.3304	74.03	0.1050	45.43	0.0917	126.82
2740.000	0.2464	-139.90	3.2393	71.51	0.1089	45.57	0.0893	129.07
2844.000	0.2053	-142.69	3.1674	68.72	0.1134	46.28	0.0896	132.63
2948.000	0.2525	-145.50	3.0927	66.24	0.1179	46.25	0.0879	136.79
3000.000	0.2559	-146.99	3.0589	64.75	0.1206	46.24	0.0897	139.73

Specifications subject to change without notice.

- North America: Tel. (800) 366-2266
- Asia/Pacific: Tel.+81-44-844-8296, Fax +81-44-844-8298
- Europe: Tel. +44 (1344) 869 595, Fax+44 (1344) 300 020

Visit [www.macom.com](http://www.macom.com) for additional data sheets and product information.

**tyco** / Electronics

**MACOM**

## Typical S-Parameter Data: 3.0 Volts @ 80 mA

Frequency MHz	S <sub>11</sub>		S <sub>21</sub>		S <sub>12</sub>		S <sub>22</sub>	
	Mag	Ang	Mag	Ang	Mag	Ang	Mag	Ang
400.000	0.2217	-37.17	6.1208	156.01	0.0596	9.08	0.2571	164.78
504.000	0.2185	-43.03	6.0097	151.06	0.0597	10.32	0.2524	159.65
608.000	0.2189	-49.53	5.8826	146.15	0.0599	11.96	0.2431	155.35
660.000	0.2183	-52.47	5.8120	143.58	0.0596	12.71	0.2372	153.28
764.000	0.2183	-58.45	5.6770	138.56	0.0599	14.81	0.2268	148.96
868.000	0.2178	-64.74	5.5235	134.02	0.0601	15.52	0.2168	145.11
972.000	0.2161	-70.43	5.3531	129.36	0.0607	19.05	0.2055	140.83
1076.000	0.2177	-76.18	5.2169	124.85	0.0615	21.45	0.1943	137.52
1180.000	0.2191	-81.63	5.0515	120.50	0.0620	23.71	0.1824	134.49
1284.000	0.2185	-86.99	4.8849	116.49	0.0640	25.82	0.1744	131.16
1388.000	0.2204	-91.89	4.7566	112.46	0.0655	28.30	0.1639	128.64
1492.000	0.2210	-96.64	4.6199	108.70	0.0668	30.25	0.1544	126.24
1596.000	0.2220	-100.87	4.4673	105.01	0.0693	32.29	0.1454	123.52
1700.000	0.2245	-105.37	4.3237	101.54	0.0715	34.45	0.1359	122.59
1804.000	0.2256	-109.44	4.2047	97.80	0.0743	36.49	0.1270	120.97
1908.000	0.2278	-112.96	4.0709	94.80	0.0774	37.77	0.1168	120.42
2012.000	0.2290	-116.96	3.9559	91.34	0.0802	39.16	0.1115	119.03
2116.000	0.2326	-120.45	3.8444	88.15	0.0833	40.17	0.1029	119.85
2220.000	0.2335	-123.50	3.7348	85.21	0.0866	41.50	0.0957	119.48
2324.000	0.2361	-127.10	3.6417	81.97	0.0907	42.69	0.0901	119.40
2428.000	0.2367	-130.26	3.5391	79.23	0.0941	43.36	0.0860	121.05
2532.000	0.2393	-133.86	3.4526	76.49	0.0979	44.38	0.0831	123.09
2636.000	0.2413	-136.65	3.3595	73.97	0.1027	44.76	0.0799	125.91
2740.000	0.2447	-139.31	3.2545	71.32	0.1065	45.55	0.0767	129.77
2844.000	0.2492	-142.46	3.1890	68.28	0.1107	46.22	0.0770	133.95
2948.000	0.2503	-144.99	3.1108	66.04	0.1155	46.29	0.0758	138.83
3000.000	0.2544	-146.53	3.0716	64.61	0.1177	46.58	0.0774	142.74

Specifications subject to change without notice.

- North America: Tel. (800) 366-2266
- Asia/Pacific: Tel.+81-44-844-8296, Fax +81-44-844-8298
- Europe: Tel. +44 (1344) 869 595, Fax+44 (1344) 300 020

Visit [www.macom.com](http://www.macom.com) for additional data sheets and product information.

**tyco** / Electronics

**MACOM**

## Typical S-Parameter Data: 5.0 Volts @ 80 mA

Frequency MHz	S <sub>11</sub>		S <sub>21</sub>		S <sub>12</sub>		S <sub>22</sub>	
	Mag	Ang	Mag	Ang	Mag	Ang	Mag	Ang
400.000	0.2201	-36.83	6.2856	155.55	0.0630	6.31	0.1920	162.51
504.000	0.2168	-42.60	6.1754	150.33	0.0630	6.80	0.1873	156.15
608.000	0.2168	-49.10	6.0428	145.41	0.0624	8.37	0.1784	151.21
660.000	0.2171	-52.05	5.9696	142.78	0.0625	8.93	0.1726	148.40
764.000	0.2169	-58.23	5.8192	137.69	0.0618	10.35	0.1628	142.85
868.000	0.2171	-64.21	5.6613	133.08	0.0616	11.53	0.1530	137.95
972.000	0.2160	-69.66	5.4627	128.34	0.0613	13.58	0.1427	131.92
1076.000	0.2182	-75.25	5.3271	123.76	0.0612	15.60	0.1316	127.62
1180.000	0.2193	-80.96	5.1602	119.36	0.0614	17.63	0.1202	123.48
1284.000	0.2186	-85.87	4.9814	115.17	0.0619	19.83	0.1124	118.48
1388.000	0.2206	-90.84	4.8421	111.31	0.0627	22.28	0.1026	114.89
1492.000	0.2220	-95.46	4.7014	107.35	0.0630	24.88	0.0931	111.09
1596.000	0.2234	-99.67	4.5447	103.59	0.0644	27.25	0.0844	106.04
1700.000	0.2250	-104.07	4.4061	100.18	0.0652	29.29	0.0744	104.39
1804.000	0.2285	-107.97	4.2764	96.52	0.0676	32.04	0.0654	100.69
1908.000	0.2291	-111.40	4.1327	93.22	0.0692	33.71	0.0543	98.35
2012.000	0.2313	-115.29	4.0120	89.86	0.0712	35.83	0.0483	95.51
2116.000	0.2344	-118.71	3.9018	86.51	0.0742	37.94	0.0381	94.97
2220.000	0.2369	-121.95	3.7920	83.58	0.0767	39.36	0.0295	91.77
2324.000	0.2396	-125.10	3.6950	80.37	0.0798	41.07	0.0229	93.73
2428.000	0.2415	-128.09	3.5850	77.59	0.0833	42.65	0.0166	100.42
2532.000	0.2439	-131.73	3.4994	74.72	0.0867	43.82	0.0130	118.93
2636.000	0.2471	-134.41	3.4058	72.17	0.0901	45.59	0.0117	160.83
2740.000	0.2499	-137.00	3.2991	69.33	0.0942	46.50	0.0148	-170.99
2844.000	0.2546	-140.01	3.2340	66.41	0.0987	47.70	0.0232	-160.77
2948.000	0.2572	-142.28	3.1539	64.07	0.1027	48.04	0.0317	-152.16
3000.000	0.2611	-143.98	3.1213	62.63	0.1050	48.47	0.0386	-151.48

Specifications subject to change without notice.

- North America: Tel. (800) 366-2266
- Asia/Pacific: Tel.+81-44-844-8296, Fax +81-44-844-8298
- Europe: Tel. +44 (1344) 869 595, Fax+44 (1344) 300 020

Visit [www.macom.com](http://www.macom.com) for additional data sheets and product information.

**tyco** / Electronics

**MACOM**

SC-70 6-Lead (SOT-363) Package <sup>1</sup>

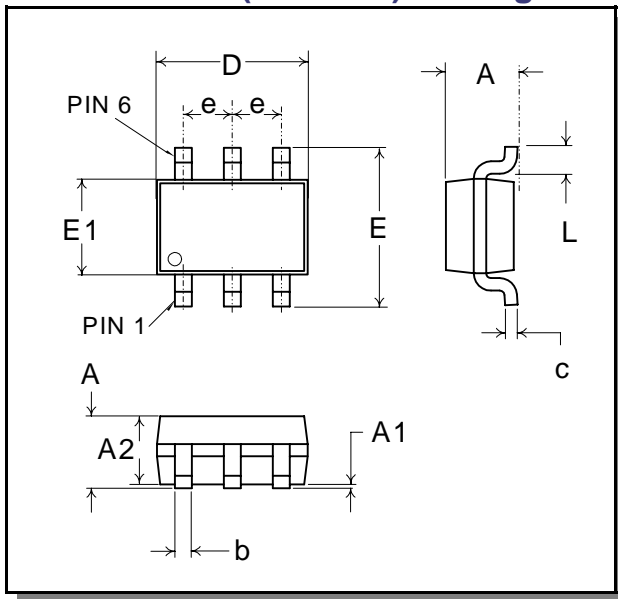

Dimensions	Measurements (mm)		
	Min.	Nom.	Max.
A	—	—	1.10
A1	0	—	0.10
A2	0.70	0.90	1.00
b	0.15	—	0.30
c	0.08	—	0.22
D	—	2.00 basic	—
e	—	0.65 basic	—
E	—	2.10 basic	—
E1	—	1.25 basic	—
L	—	0.42 ref.	—

1. See JEDEC MO-203 VAR AB for additional dimensions and tolerances.

Ordering Information

Part Number	Package
MAALSS0012TR	1000 tape and reel <sup>1</sup>
MAALSS0012-3000	3000 tape and reel <sup>1</sup>
MAALSS0012SMB	Sample test board

1. Please see Application Note M513 for reel size information.

Specifications subject to change without notice.

- North America: Tel. (800) 366-2266
- Asia/Pacific: Tel.+81-44-844-8296, Fax +81-44-844-8298
- Europe: Tel. +44 (1344) 869 595, Fax+44 (1344) 300 020

Visit [www.macom.com](http://www.macom.com) for additional data sheets and product information.