



Low Cost Five-Way GMIC SMT Power Divider 1850-1990 MHz

Features

- Small Size, Low Profile
- Superior Repeatability (Lot-to-Lot Variation)
- Industry Standard SOIC-16 SMT Plastic Package
- Typical Isolation: 28 dB
- Typical Insertion Loss: 0.7 dB
- Low Cost
- 1 Watt Power Handling

Description

M/A-COM's DS55-0003 is an IC-based monolithic power divider using M/A-COM's GMIC technology in a low cost SOIC-16 plastic package. This 5-way power divider is ideally suited for applications where PCB real estate is at a premium and part count reduction and cost are critical. Typical applications include base station switching networks and other cellular equipment, including subscriber units. Available in tape and reel.

The DS55-0003 is fabricated using a passive-integrated circuit process. The process features full-chip passivation for increased performance and reliability.

SOIC-16

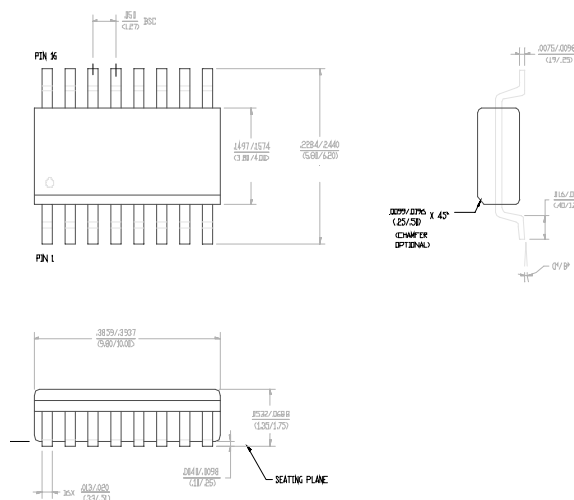

Ordering Information

Part Number	Package
DS55-0003	SOIC-16 Lead Plastic Package
DS55-0003-TR	Forward Tape and Reel ¹
DS55-0003-RTR	Reverse Tape and Reel ¹

1. If specific reel size is required, consult factory for part number assignment.

Typical Electrical Specifications¹, T_A = +25°C

Parameter	Units	Min	Typ	Max
Insertion Loss Above 6.0dB	dB	—	0.7	1.2
Isolation	dB	21	28	—
VSWR Input	—	—	1.5:1	1.6:1
VSWR Output	—	—	1.2:1	1.5:1
Amplitude Balance	dB	—	0.2	0.5
Phase Balance	°	—	6	12

1. All specifications apply with a 50-Ohm source and load impedance.

Specifications subject to change without notice.

■ **North America:** Tel. (800) 366-2266, Fax (800) 618-8883
 ■ **Asia/Pacific:** Tel.+81-44-844-8296, Fax +81-44-844-8298
 ■ **Europe:** Tel. +44 (1344) 869 595, Fax+44 (1344) 300 020

Visit www.macom.com for additional data sheets and product information.

tyco Electronics

M/A-COM

Absolute Maximum Ratings¹

Parameter	Absolute Maximum
Input Power ²	1 W CW
Operating Temperature	-40°C to +85°C
Storage Temperature	-65°C to +150°C

1. Exceeding these limits may cause permanent damage.
2. With Internal load dissipation of 0.125 W maximum.

Functional Diagram

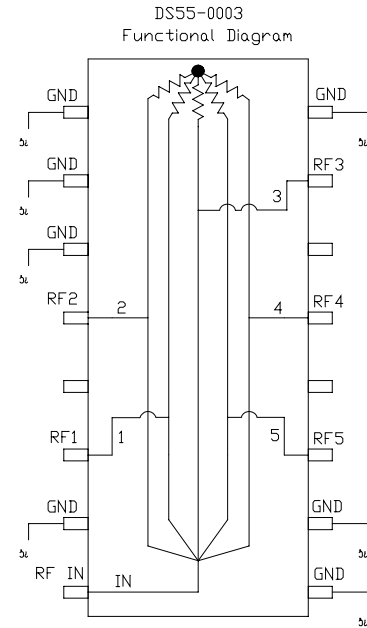

Pins labeled as ground should be DC and RF grounded

Specifications subject to change without notice.

- North America: Tel. (800) 366-2266, Fax (800) 618-8883
- Asia/Pacific: Tel.+81-44-844-8296, Fax +81-44-844-8298
- Europe: Tel. +44 (1344) 869 595, Fax+44 (1344) 300 020

Visit www.macom.com for additional data sheets and product information.