

Digital Attenuator, 5 Bit, 15.5 dB, 500 - 2500 MHz

MAATSS0001

Features

- 5 Bits, 0.5 dB Steps
- Excellent Accuracy
- Single Positive Control (+3 to +5V)
- Small Low Cost QSOP-16 (SSOP-16) Package

Description

The M/A-COM MAATSS0001 is a 0.5 dB step GaAs MMIC digital attenuator with 15.5 dB dynamic range in a low cost QSOP-16 (SSOP-16) package. It requires external DC blocking capacitors on the RF ports, positive supply voltage and five individual bit control voltages. It is particularly suited where high attenuation accuracy, low insertion loss and low intermodulation products are required. Typical applications include base stations, wireless data, and wireless local loop gain level control circuits.

The MAATSS0001 is fabricated using M/A-COM's GaAs 1.0 micron process. The process features full chip passivation for increased performance and reliability.

Functional Schematic

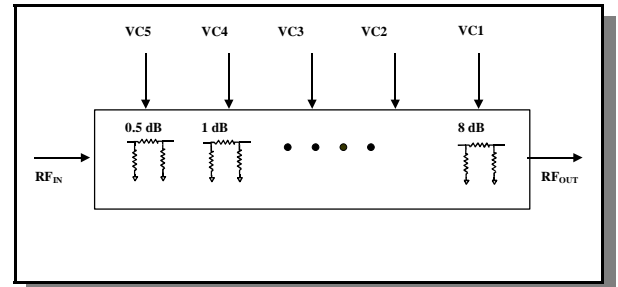

Absolute Maximum Ratings ¹

Parameter	Absolute Maximum
Max Input Power 0.5 - 2.5 GHz	+34 dBm
Operating Temperature	-40°C to +85°C
Storage Temperature	-65°C to +150°C

1. Operation of this device above any one of these parameters may cause permanent damage.

Electrical Specifications: $T_A = 25\text{ }^\circ\text{C}$, $Z_0 = 50\text{ }\Omega$

Parameter	Conditions	Frequency	Units	Min.	Typ.	Max.
Insertion Loss	—	0.5 - 1.8 GHz	dB	—	1.9	2.2
		1.8 - 2.2 GHz	dB	—	2.2	2.5
		2.2 - 2.5 GHz	dB	—	2.5	2.8
VSWR	Any State	0.5 - 2.5 GHz	Ratio	—	1.6:1	1.9:1
Accuracy	Any State	0.5 - 0.8 GHz		± (0.3 + 4% atten setting)		
		0.8 - 1.8 GHz		± (0.3 + 3% atten setting)		
		1.8 - 2.2 GHz		± (0.3 + 6% atten setting)		
		2.2 - 2.5 GHz		± (0.3 + 8% atten setting)		
Step Change	Any State	0.5 - 1.8 GHz	dB	0.3	—	0.8
		1.8 - 2.2 GHz	dB	0.2	—	0.9
		2.2 - 2.5 GHz	dB	0.1	—	1.0
Attenuation Range	—	0.5 - 2.5 GHz	dB	14.0	15.0	—
1 dB Compression Input Power	+3 V +5 V	0.5 - 2.5 GHz	dBm	19	25	—
		0.5 - 2.5 GHz	dBm	22	30	—
IP3	+3 V Two tones input power up to +5 dBm +5 V Two tones input power up to +5 dBm	0.5 - 2.5 GHz	dBm	34	36	—
		0.5 - 2.5 GHz	dBm	43	46	—
Trise, Tfall	10/90% or 90/10% RF	—	µS	—	2.14	—
Ton, Toff	50% CNTL to 90/10% RF	—	µS	—	2.14	—
Transients	In Band	—	mV	—	62	—
Control Voltages	+3 V +5 V	—	µA	—	—	40
		—	µA	—	—	40

Pin Out

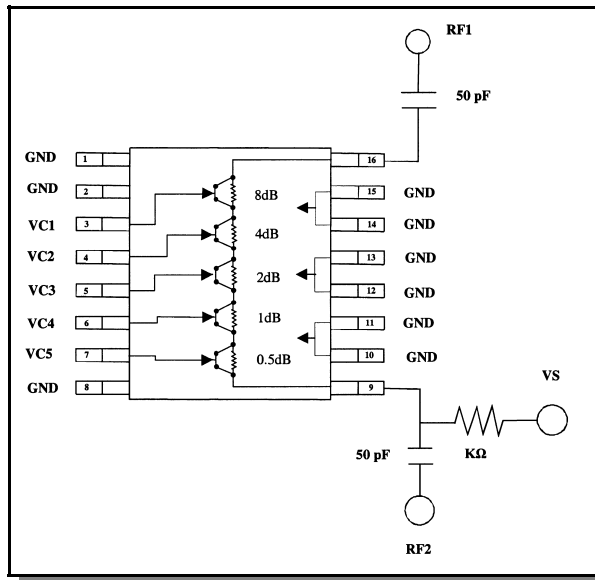

QSOP-16 (SSOP-16)

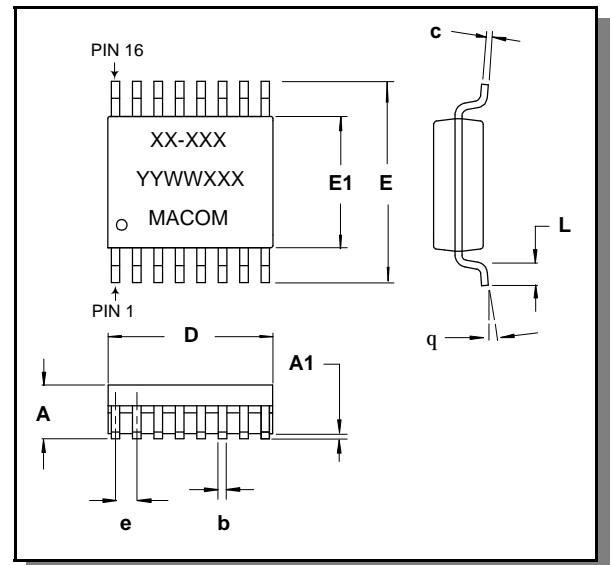

Truth Table

Control Inputs					Attenuation (dB)
VC5	VC4	VC3	VC2	VC1	
1	1	1	1	1	Reference
0	1	1	1	1	0.5 dB
1	0	1	1	1	1 dB
1	1	0	1	1	2 dB
1	1	1	0	1	4 dB
1	1	1	1	0	8 dB

1 = Vhigh = (Vs ± 0.1) V, 0 = (0.0 ± 0.2) V

Dimensions	Measurement (Inches)		
	Minimum	Nominal	Maximum
A	0.053	0.064	0.069
A1	0.004	0.006	0.010
b	0.008	—	0.012
c	0.007	—	0.010
D	0.189	0.193	0.197
e	0.025 basic	0.025 basic	0.025 basic
E	0.228	0.236	0.244
E1	0.150	0.154	0.157
L	0.016	0.025	0.050
0	—	0.025 basic	—

Specifications subject to change without notice.

- North America: Tel. (800) 366-2266
- Asia/Pacific: Tel.+81-44-844-8296, Fax +81-44-844-8298
- Europe: Tel. +44 (1344) 869 595, Fax+44 (1344) 300 020

Visit www.macom.com for additional data sheets and product information.

Typical Performance Curves

Attenuation Flatness vs. Frequency

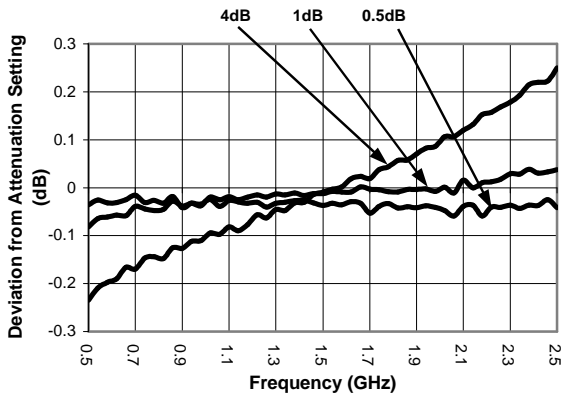

Attenuation Flatness vs. Frequency

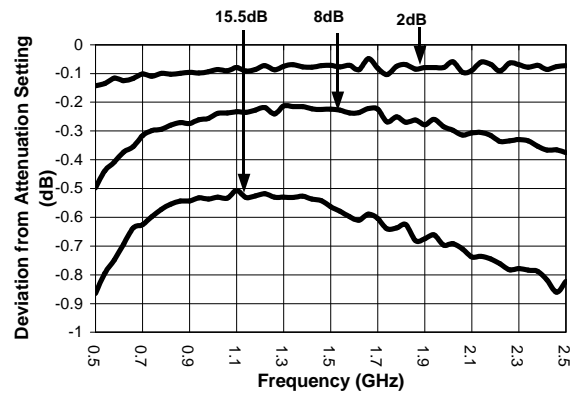

VSWR vs. Frequency

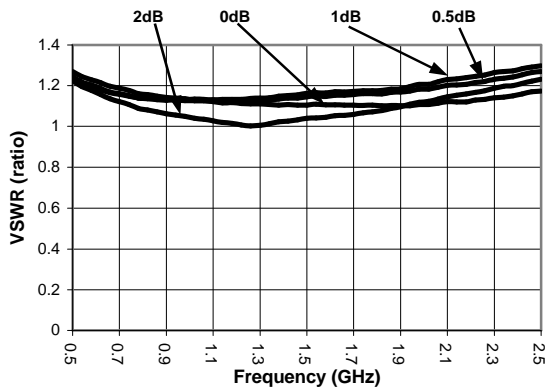

VSWR vs. Frequency

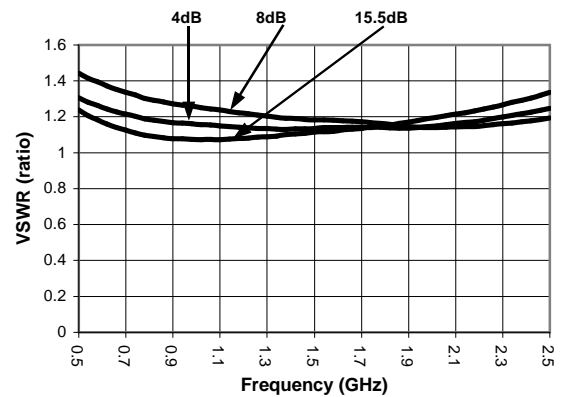

Insertion Loss vs. Frequency

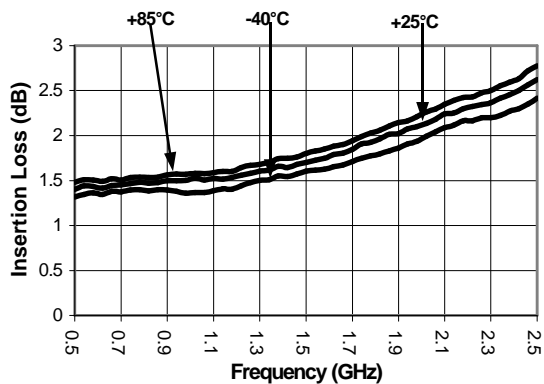

Ordering Information

Part Number	Package
MAATSS0001	Bulk Packaging
MAATSS0001TR	Tape and Reel (1K Reel)
MAATSS0001-TB	Units Mounted on Test Board

Specifications subject to change without notice.

- North America: Tel. (800) 366-2266
- Asia/Pacific: Tel.+81-44-844-8296, Fax +81-44-844-8298
- Europe: Tel. +44 (1344) 869 595, Fax+44 (1344) 300 020

Visit www.macom.com for additional data sheets and product information.