

## Features

- Operates DC - 4 GHz on Single Supply
- ASIC TTL / CMOS Driver
- Leadless 4 x 6 mm Chip Scale Plastic Package
- Low DC Power Consumption
- 50 Ohm Nominal Impedance
- Test Boards are Available
- Tape and Reel are Available

## Description

M/A-COM's SW90-0002 is a SPDT absorptive pHEMT switch with integral TTL driver. This device is in an MLP plastic surface mount package. This switch offers excellent broadband performance and repeatability from DC to 4 GHz, while maintaining low DC power dissipation. The SW90-0002 is ideally suited for wireless infrastructure applications.

## CSP-1

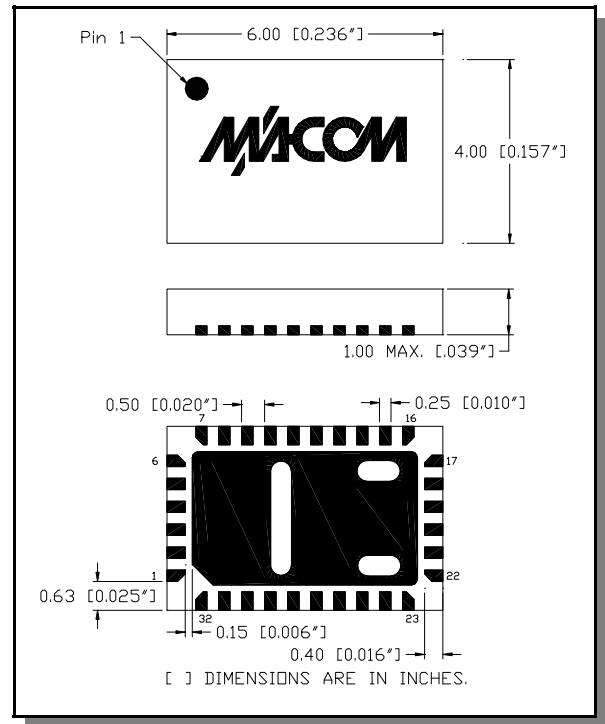

## Electrical Specifications: $T_A = 25^\circ\text{C}$

Parameter	Test Conditions	Frequency	Units	Min.	Typ.	Max.
Insertion Loss	RFC—RF1,RF2 (Logic per truth table)	DC - 4.0 GHz	dB	—	—	1.8
Isolation	RF1—RF2 (All Logic "0")	DC - 4.0 GHz	dB	30	—	—
VSWR	On (RFC,RF1, RF2) (Logic per truth table)	DC - 4.0 GHz	Ratio	—	—	2.0:1
VSWR	Off (RF1, RF2) (Logic per truth table)	DC - 4.0 GHz	Ratio	—	—	1.8:1
1 dB Compression	— —	50 MHz	dBm	—	18	—
		0.5 - 4.0 GHz	dBm	—	29	—
Input $IP_3$	Two-tone inputs up to +5 dBm	50 MHz	dBm	—	36	—
		0.5 - 4.0 GHz	dBm	—	46	—
Switching Speed	Ton (50% Control to 10% RF)		nS	—	31	—
	Toff (50% Control to 90% RF)		nS	—	19	—
	Trise (10% to 90% RF)		nS	—	6	—
	Tfall (90% to 10% RF)		nS	—	2	—
Vcc	—	—	V	4.5	5.0	5.5
Logic "0"	Sink Current is 20 $\mu\text{A}$ max.	—	V	0.0	—	0.8
Logic "1"	Source Current is 20 $\mu\text{A}$ max.	—	V	2.0	—	5.0
Icc	Vcc min to max, Logic "0" or "1"	—	mA	—	5	8

Pin Configuration <sup>1,2,3</sup>

Pin No.	Function	Pin No.	Function
1	NC	17	NC
2	GND	18	C1
3	RFC	19	NC
4	GND	20	V <sub>CC</sub>
5	NC	21	NC
6	NC	22	NC
7	GND	23	CP1
8	RF1	24	CP2
9	GND	25	NC
10	NC	26	V <sub>EE</sub>
11	NC	27	NC
12	V <sub>EE</sub>	28	NC
13	NC	29	NC
14	V <sub>CC</sub>	30	GND
15	NC	31	RF2
16	NC	32	GND

1. NC = No Connection
2. V<sub>EE</sub> is internally generated and must remain isolated from external power supplies.
3. Connections and external components shown in functional schematic are required. 0.1  $\mu$ F Capacitors need to be located near pins 20 & 26.

## Functional Schematic

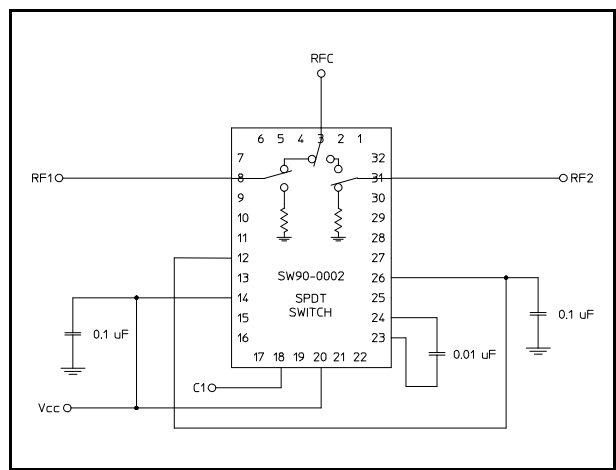
Absolute Maximum Ratings <sup>4,5</sup>

Parameter	Absolute Maximum
Max. Input Power 0.05 GHz 0.5 - 4.0 GHz	+27 dBm +34 dBm
Bias Voltages V <sub>CC</sub> Control Voltage <sup>6</sup>	+5.5V -0.5V to V <sub>CC</sub> +0.5V
Operating Temperature	-40°C to +85°C
Storage Temperature	-65°C to +125°C

4. Operation of this device above any one of these parameters may cause permanent damage.
5. When the RF input is applied to the terminated port, the absolute maximum power is +30 dBm.
6. Standard CMOS TTL interface, latch-up will occur if logic signal is applied prior to power supply.

## Truth Table

Control Input	Condition of the Switch	
	RF Common to each RF Port	
C1	RF1	RF2
0	Off	On
1	On	Off

"0" = TTL Low "1" = TTL High

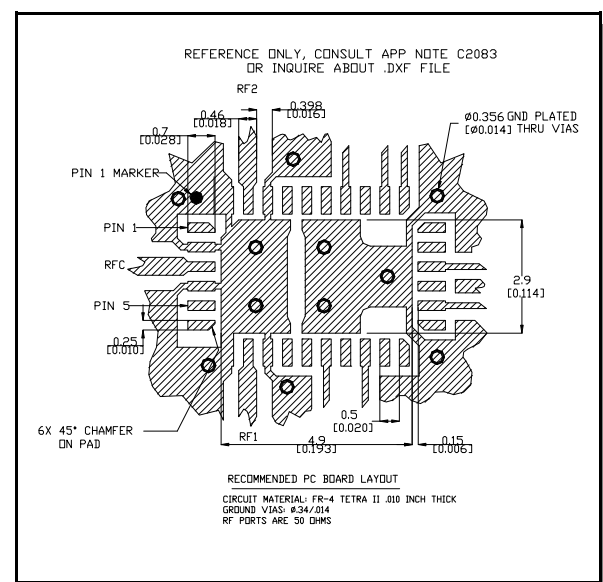
Recommended PCB Layout <sup>7</sup>

7. Application Note C2083 is available on line at [www.macom.com](http://www.macom.com)

Specifications subject to change without notice.

- North America: Tel. (800) 366-2266
- Asia/Pacific: Tel. +81-44-844-8296, Fax +81-44-844-8298
- Europe: Tel. +44 (1344) 869 595, Fax +44 (1344) 300 020

Visit [www.macom.com](http://www.macom.com) for additional data sheets and product information.

### Typical Performance Curves

**Insertion Loss vs. Frequency**

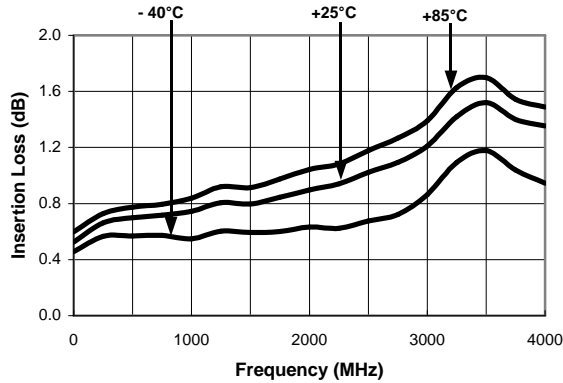

**Isolation (dB) vs. Frequency**

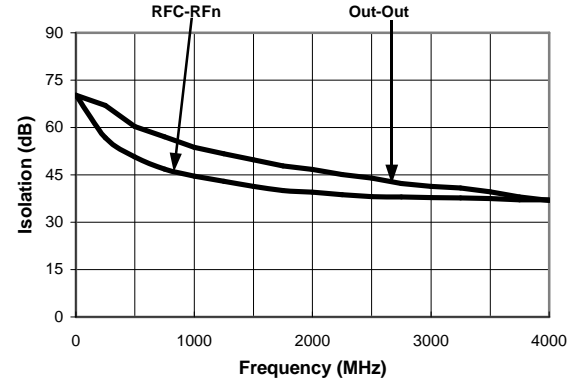

**On VSWR vs. Frequency**

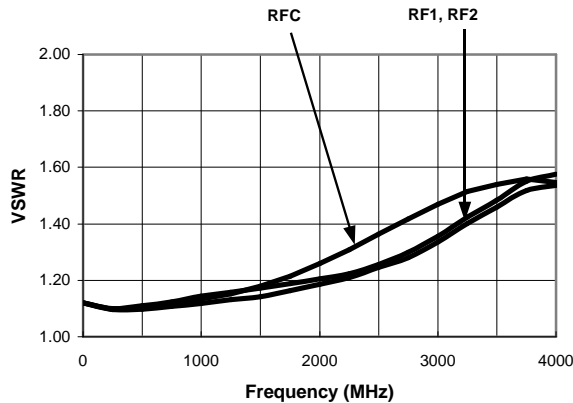

**VSWR (Terminations) vs. Frequency**

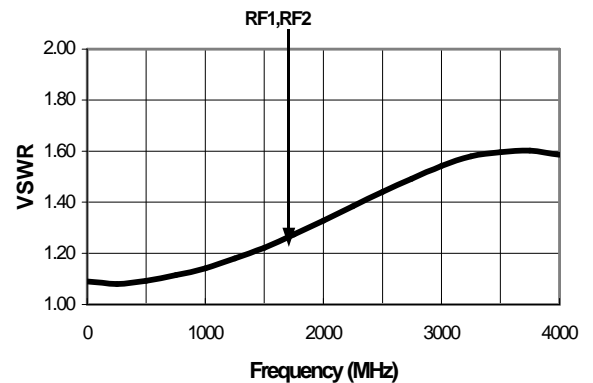

### Ordering Information

Part Number	Package
SW90-0002	Bulk Packaging
SW90-0002TR	Tape and Reel (1K Reel)
SW90-0002-TB	Units Mounted on Test Board

Specifications subject to change without notice.

- North America: Tel. (800) 366-2266
- Asia/Pacific: Tel.+81-44-844-8296, Fax +81-44-844-8298
- Europe: Tel. +44 (1344) 869 595, Fax+44 (1344) 300 020

Visit [www.macom.com](http://www.macom.com) for additional data sheets and product information.