

Low Cost SMT Low Pass Filter DC - 2000 MHz



Features

- Small Size and Low Profile
- Industry Standard SOIC-8 SMT Plastic Package
- Superior Repeatability
- Typical Insertion Loss 0.6 dB
- Typical Rejection 20dB
- 2 Watt Power Handling

Description

M/A-COM's FL07-0002-G is an IC-based monolithic low pass filter in a low cost SOIC-8 plastic package. This filter is ideally suited for applications where small size, low cost and low loss are required.

Typical applications include base station switching networks and portable phones where size and PCB real estate are at a premium. Available in tape and reel.

The FL07-0002-G is fabricated using a passive-integrated circuit process. The process features full-chip passivation for increased performance and reliability.

SO-8

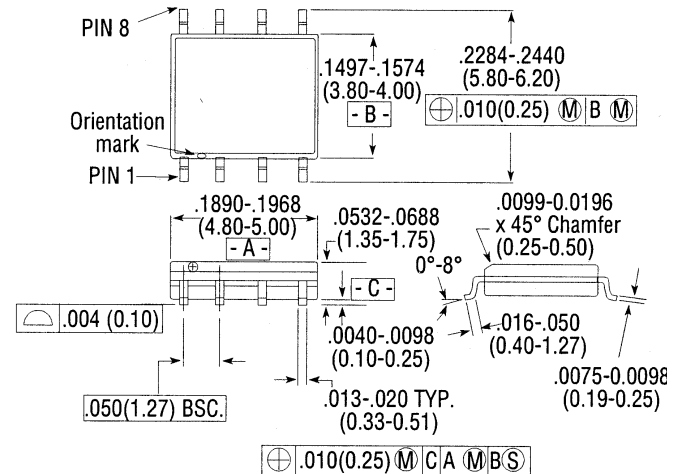

8- Lead SOP outline dimensions
Narrow body .150

(All dimensions per JEDEC No. MS-012-AA, Issue C)
Dimensions in () are in mm.

Unless Otherwise Noted: .xxx = ± 0.010 (.xx = ± 0.25)
.xx = ± 0.02 (.x = ± 0.5)

Ordering Information

Part Number	Package
FL07-0002-G	SOIC 8-Lead Plastic Package
FL07-0002-G-TR	Forward Tape and Reel*
FL07-0002-G-RTR	Reverse Tape and Reel*

* If specific reel size is required, consult factory for part number assignment.

Typical Electrical Specifications¹, $T_A = +25^\circ\text{C}$

Parameter	Units	Min	Typ	Max
Insertion Loss: DC-2000MHz	dB	—	0.6	1.0
VSWR: DC-2000 MHz			1.6:1	2.0:1
Rejection: 3500-4000 MHz	dB	15	20	
4000-6000 MHz	dB	20	30	

1. All specifications apply with a 50-Ohm source and load impedance.

Absolute Maximum Ratings¹

Parameter	Absolute Maximum
Input Power	2 W CW
Operating Temperature	-40°C to +85°C
Storage Temperature	-65°C to +150°C

1. Exceeding these limits may cause permanent damage.

Functional Diagram

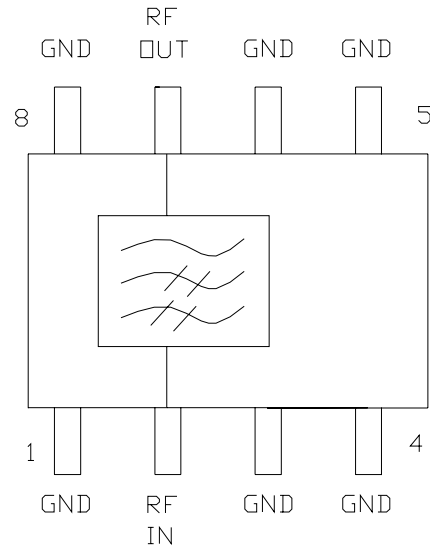

All unused pins must be RF and DC grounded.
Pins 1 and 4 are thermal ground contacts.

Typical Performance @ +25°C

Insertion Loss vs Frequency

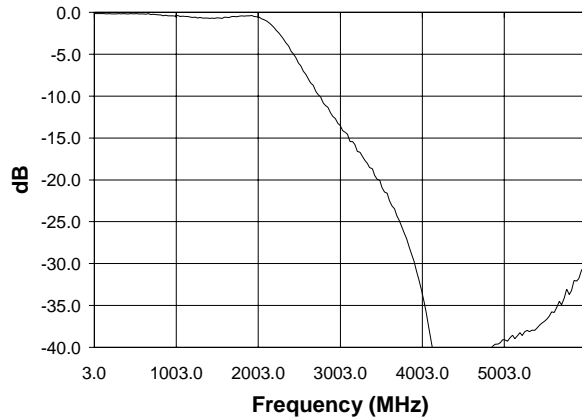

VSWR vs Frequency

