



Single/Dual/Quad, Wide-Bandwidth, Low-Power, Single-Supply, Rail-to-Rail I/O Op Amps

General Description

The MAX4130–MAX4134 family of operational amplifiers combines 10MHz gain-bandwidth product and excellent DC accuracy with rail-to-rail operation at the inputs and outputs. These devices require only 900 μ A per amplifier, and operate from either a single supply (+2.7V to +6.5V) or dual supplies (\pm 1.35V to \pm 3.25V) with a common-mode voltage range that extends 250mV beyond V_{EE} and V_{CC} . They are capable of driving 250 Ω loads and are unity-gain stable. In addition, the MAX4131/MAX4133 feature a shutdown mode in which the outputs are placed in a high-impedance state and the supply current is reduced to only 25 μ A per amplifier.

With their rail-to-rail input common-mode range and output swing, the MAX4130–MAX4134 are ideal for low-voltage, single-supply operation. Although the minimum operating voltage is specified at 2.7V, the devices typically operate down to 1.8V. In addition, low offset voltage and high speed make them the ideal signal-conditioning stages for precision, low-voltage data-acquisition systems. **The MAX4130 comes in the space-saving SOT23-5 package.**

Selection Table

| PART | AMPS PER PACKAGE | SHUTDOWN MODE | PIN-PACKAGE |
|---------|------------------|---------------|-----------------|
| MAX4130 | 1 | — | 5 SOT23-5 |
| MAX4131 | 1 | Yes | 8 SO/ μ MAX |
| MAX4132 | 2 | — | 8 SO/ μ MAX |
| MAX4133 | 2 | Yes | 14 SO |
| MAX4134 | 4 | — | 14 SO |

Applications

Battery-Powered Instruments
 Portable Equipment
 Data-Acquisition Systems
 Signal Conditioning
 Low-Power, Low-Voltage Applications

Pin Configurations appear at end of data sheet.

Features

- ◆ 5-Pin SOT23-5 Package (MAX4130)
- ◆ +2.7V to +6.5V Single-Supply Operation
- ◆ Rail-to-Rail Input Common-Mode Voltage Range
- ◆ Rail-to-Rail Output Voltage Swing
- ◆ 10MHz Gain-Bandwidth Product
- ◆ 900 μ A Quiescent Current per Amplifier
- ◆ 25 μ A Shutdown Function (MAX4131/MAX4133)
- ◆ 200 μ V Offset Voltage
- ◆ No Phase Reversal for Overdriven Inputs
- ◆ Drive 250 Ω Loads
- ◆ Stable with 160pF Capacitive Loads
- ◆ Unity-Gain Stable

Ordering Information

| PART | TEMP. RANGE | PIN-PACKAGE | SOT TOP MARK |
|------------|----------------|-------------|--------------|
| MAX4130EUK | -40°C to +85°C | 5 SOT23-5 | AABB |
| MAX4131C/D | 0°C to +70°C | Dice* | — |
| MAX4131ESA | -40°C to +85°C | 8 SO | — |
| MAX4131EUA | -40°C to +85°C | 8 μ MAX | — |

Ordering Information continued at end of data sheet.

*Dice are specified at $T_A = +25^\circ\text{C}$, DC parameters only.

Typical Operating Circuit

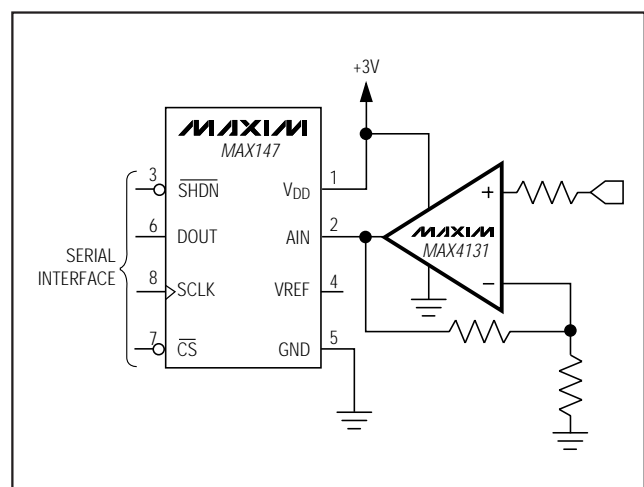

Single/Dual/Quad, Wide-Bandwidth, Low-Power, Single-Supply Rail-to-Rail I/O Op Amps

ABSOLUTE MAXIMUM RATINGS

| | |
|--|--|
| Supply Voltage (V_{CC} - V_{EE}) | 7.5V |
| $IN+$, $IN-$, \overline{SHDN} Voltage | ($V_{CC} + 0.3V$) to ($V_{EE} - 0.3V$) |
| Output Short-Circuit Duration (Note 1) | Continuous (short to either supply) |
| Continuous Power Dissipation ($T_A = +70^\circ C$) | |
| 5-pin SOT23-5 (derate 7.1mW/ $^\circ C$ above $+70^\circ C$) | 571mW |
| 8-pin SO (derate 5.88mW/ $^\circ C$ above $+70^\circ C$) | 471mW |
| 8-pin μ MAX (derate 4.10mW/ $^\circ C$ above $+70^\circ C$) | 330mW |
| 14-pin SO (derate 8.00mW/ $^\circ C$ above $+70^\circ C$) | 640mW |

| | |
|-------------------------------------|-----------------------------------|
| Operating Temperature Range | |
| MAX413_E__ | -40 $^\circ C$ to +85 $^\circ C$ |
| Maximum Junction Temperature | +150 $^\circ C$ |
| Storage Temperature Range | -65 $^\circ C$ to +160 $^\circ C$ |
| Lead Temperature (soldering, 10sec) | +300 $^\circ C$ |

Note 1: Provided that the maximum package power-dissipation rating is met.

Stresses beyond those listed under "Absolute Maximum Ratings" may cause permanent damage to the device. These are stress ratings only, and functional operation of the device at these or any other conditions beyond those indicated in the operational sections of the specifications is not implied. Exposure to absolute maximum rating conditions for extended periods may affect device reliability.

DC ELECTRICAL CHARACTERISTICS

($V_{CC} = +2.7V$ to $+6.5V$, $V_{EE} = 0V$, $V_{CM} = 0V$, $V_{OUT} = V_{CC} / 2$, R_L tied to $V_{CC} / 2$, $\overline{SHDN} \geq 2V$ (or open), $T_A = +25^\circ C$, unless otherwise noted.)

| PARAMETER | CONDITIONS | | MIN | TYP | MAX | UNITS |
|---------------------------------|---|---|-----------------|------------|-----------------|------------|
| Input Offset Voltage | $V_{CM} = V_{EE}$ to V_{CC} | MAX4130EUK | | ± 0.35 | ± 1.50 | mV |
| | | MAX4131ESA | | ± 0.20 | ± 0.60 | |
| | | MAX4131EUA | | ± 0.35 | ± 1.20 | |
| | | MAX4132ESA/MAX4133ESD | | ± 0.25 | ± 0.75 | |
| | | MAX4132EUA | | ± 0.40 | ± 1.50 | |
| | | MAX4134ESD | | ± 0.35 | ± 1.50 | |
| Input Bias Current | $V_{CM} = V_{EE}$ to V_{CC} | | | ± 50 | ± 150 | nA |
| Input Offset Current | $V_{CM} = V_{EE}$ to V_{CC} | | | ± 1 | ± 12 | nA |
| Differential Input Resistance | $-1.5V < V_{DIFF} < 1.5V$ | | | 500 | | k Ω |
| Common-Mode Input Voltage Range | | | $V_{EE} - 0.25$ | | $V_{CC} + 0.25$ | V |
| Common-Mode Rejection Ratio | $(V_{EE} - 0.25V) < V_{CM} < (V_{CC} + 0.25V)$ | MAX4130EUK | 67 | 90 | | dB |
| | | MAX4131ESA | 78 | 98 | | |
| | | MAX4131EUA | 68 | 88 | | |
| | | MAX4132ESA/MAX4133ESD | 74 | 94 | | |
| | | MAX4132EUA | 66 | 86 | | |
| | | MAX4134ESD | 64 | 84 | | |
| Power-Supply Rejection Ratio | $V_{CC} = 2.7V$ to $6.5V$ | | 78 | 100 | | dB |
| Output Resistance | $A_V = 1$ | | | 0.1 | | Ω |
| Off-Leakage Current | $\overline{SHDN} < 0.8V$, $V_{OUT} = 0V$ to V_{CC} | | | ± 0.1 | ± 1 | μA |
| Large-Signal Voltage Gain | $V_{CC} = 2.7V$ | $V_{OUT} = 0.25V$ to $2.45V$, $R_L = 100k\Omega$ | 92 | 108 | | dB |
| | | $V_{OUT} = 0.4V$ to $2.3V$, $R_L = 250\Omega$ | 72 | 82 | | |
| | $V_{CC} = 5V$ | $V_{OUT} = 0.25V$ to $4.75V$, $R_L = 100k\Omega$ | 94 | 108 | | |
| | | $V_{OUT} = 0.4V$ to $4.6V$, $R_L = 250\Omega$ | 75 | 86 | | |

Single/Dual/Quad, Wide-Bandwidth, Low-Power, Single-Supply Rail-to-Rail I/O Op Amps

MAX4130-MAX4134

DC ELECTRICAL CHARACTERISTICS (continued)

($V_{CC} = +2.7V$ to $+6.5V$, $V_{EE} = 0V$, $V_{CM} = 0V$, $V_{OUT} = V_{CC} / 2$, R_L tied to $V_{CC} / 2$, $\overline{SHDN} \geq 2V$ (or open), $T_A = +25^\circ C$, unless otherwise noted.)

| PARAMETER | CONDITIONS | | | MIN | TYP | MAX | UNITS |
|---------------------------------------|--|--------------------|-------------------|---------|---------|---------|-------|
| Output Voltage Swing | MAX4130/ MAX4131 | $R_L = 100k\Omega$ | $V_{CC} - V_{OH}$ | 12 | 20 | mV | |
| | | | $V_{OL} - V_{EE}$ | 20 | 35 | | |
| | | $R_L = 250\Omega$ | $V_{CC} - V_{OH}$ | 240 | 290 | | |
| | | | $V_{OL} - V_{EE}$ | 125 | 170 | | |
| | MAX4132/ MAX4133/ MAX4134 | $R_L = 100k\Omega$ | $V_{CC} - V_{OH}$ | 15 | 30 | | |
| | | | $V_{OL} - V_{EE}$ | 25 | 40 | | |
| | $R_L = 250\Omega$ | $V_{CC} - V_{OH}$ | 280 | 330 | | | |
| | | $V_{OL} - V_{EE}$ | 180 | 230 | | | |
| Output Short-Circuit Current | | | | 50 | | mA | |
| \overline{SHDN} Logic Threshold | MAX4131-MAX4134 | | Low | 0.8 | | V | |
| | | | High | 2.0 | | | |
| \overline{SHDN} Input Current | MAX4131-MAX4134 | | | ± 1 | ± 3 | μA | |
| Operating Supply-Voltage Range | | | | 2.7 | 6.5 | V | |
| Supply Current per Amplifier | $V_{CM} = V_{OUT} = V_{CC} / 2$ | | $V_{CC} = 2.7V$ | 900 | 1050 | μA | |
| | | | $V_{CC} = 5V$ | 1000 | 1150 | | |
| Shutdown Supply Current per Amplifier | $\overline{SHDN} > 0.8V$, MAX4131-MAX4134 | | $V_{CC} = 2.7V$ | 25 | 40 | μA | |
| | | | $V_{CC} = 5V$ | 40 | 60 | | |

DC ELECTRICAL CHARACTERISTICS

($V_{CC} = +2.7V$ to $+6.5V$, $V_{EE} = 0V$, $V_{CM} = 0V$, $V_{OUT} = V_{CC} / 2$, R_L tied to $V_{CC} / 2$, $\overline{SHDN} \geq 2V$ (or open), $T_A = -40^\circ C$ to $+85^\circ C$, unless otherwise noted.)

| PARAMETER | CONDITIONS | | | MIN | TYP | MAX | UNITS |
|---------------------------------|--|-----------------------|--|-----------------|------------|------------------|-------|
| Input Offset Voltage | $V_{CM} = V_{EE}$ to V_{CC} | MAX4130EUK | | | ± 3.50 | mV | |
| | | MAX4131ESA | | | ± 0.75 | | |
| | | MAX4131EUA | | | ± 4.40 | | |
| | | MAX4132ESA/MAX4133ESD | | | ± 0.95 | | |
| | | MAX4132EUA | | | ± 4.70 | | |
| | | MAX4134ESD | | | ± 4.00 | | |
| Input Offset Voltage Tempco | | | | | ± 2 | $\mu V/^\circ C$ | |
| Input Bias Current | $V_{CM} = V_{EE}$ to V_{CC} | | | | | ± 160 | nA |
| Input Offset Current | $V_{CM} = V_{EE}$ to V_{CC} | | | | | ± 18 | nA |
| Common-Mode Input Voltage Range | | | | $V_{EE} - 0.20$ | | $V_{CC} + 0.20$ | V |
| Common-Mode Rejection Ratio | $(V_{EE} - 0.2V) < V_{CM} < (V_{CC} + 0.2V)$ | MAX4130EUK | | 62 | | dB | |
| | | MAX4131ESA | | 76 | | | |
| | | MAX4131EUA | | 60 | | | |
| | | MAX4132ESA/MAX4133ESD | | 74 | | | |
| | | MAX4132EUA | | 58 | | | |
| | | MAX4134ESD | | 60 | | | |

Single/Dual/Quad, Wide-Bandwidth, Low-Power, Single-Supply Rail-to-Rail I/O Op Amps

DC ELECTRICAL CHARACTERISTICS (continued)

($V_{CC} = +2.7V$ to $+6.5V$, $V_{EE} = 0V$, $V_{CM} = 0V$, $V_{OUT} = V_{CC} / 2$, R_L tied to $V_{CC} / 2$, $\overline{SHDN} \geq 2V$ (or open), $T_A = -40^\circ C$ to $+85^\circ C$, unless otherwise noted.)

| PARAMETER | CONDITIONS | | MIN | TYP | MAX | UNITS |
|---------------------------------------|---|---|-------------------|-----|----------|---------|
| Power-Supply Rejection Ratio | $V_{CC} = 2.7V$ to $6.5V$ | | 74 | | | dB |
| Off-Leakage Current | $\overline{SHDN} < 0.8V$, $V_{OUT} = 0V$ to V_{CC} | | | | ± 12 | μA |
| Large-Signal Voltage Gain | $V_{CC} = 2.7V$ | $V_{OUT} = 0.25V$ to $2.45V$, $R_L = 100k\Omega$ | 84 | | | dB |
| | | $V_{OUT} = 0.4V$ to $2.3V$, $R_L = 250\Omega$ | 66 | | | |
| | $V_{CC} = 5V$ | $V_{OUT} = 0.25V$ to $4.75V$, $R_L = 100k\Omega$ | 86 | | | |
| | | $V_{OUT} = 0.4V$ to $4.6V$, $R_L = 250\Omega$ | 68 | | | |
| Output Voltage Swing | MAX4130/ MAX4131 | $R_L = 100k\Omega$ | $V_{CC} - V_{OH}$ | | 25 | mV |
| | | | $V_{OL} - V_{EE}$ | | 40 | |
| | | $R_L = 250\Omega$ | $V_{CC} - V_{OH}$ | | 300 | |
| | | | $V_{OL} - V_{EE}$ | | 190 | |
| | MAX4132/ MAX4133/ MAX4134 | $R_L = 100k\Omega$ | $V_{CC} - V_{OH}$ | | 35 | |
| | | | $V_{OL} - V_{EE}$ | | 50 | |
| | | $R_L = 250\Omega$ | $V_{CC} - V_{OH}$ | | 350 | |
| | | | $V_{OL} - V_{EE}$ | | 250 | |
| \overline{SHDN} Logic Threshold | MAX4131-MAX4134 | | Low | | 0.8 | V |
| | | | High | 2.0 | | |
| \overline{SHDN} Input Current | MAX4131-MAX4134 | | | | ± 3 | μA |
| Operating Supply-Voltage Range | | | 2.7 | | 6.5 | V |
| Supply Current per Amplifier | $V_{CM} = V_{OUT} = V_{CC} / 2$ | | $V_{CC} = 2.7V$ | | 1100 | μA |
| | | | $V_{CC} = 5V$ | | 1200 | |
| Shutdown Supply Current per Amplifier | $\overline{SHDN} < 0.8V$, MAX4131-MAX4134 | | $V_{CC} = 2.7V$ | | 50 | μA |
| | | | $V_{CC} = 5V$ | | 70 | |

AC ELECTRICAL CHARACTERISTICS

($V_{CC} = +2.7V$ to $+6.5V$, $V_{EE} = 0V$, $\overline{SHDN} \geq 2V$ (or open), $T_A = +25^\circ C$, unless otherwise noted.)

| PARAMETER | CONDITIONS | | MIN | TYP | MAX | UNITS |
|-----------------------------|--|--|---------|-------|-----|----------------|
| Gain-Bandwidth Product | | | | 10 | | MHz |
| Phase Margin | | | | 62 | | degrees |
| Gain Margin | | | | 12 | | dB |
| Total Harmonic Distortion | $f = 10kHz$, $V_{OUT} = 2V_{p-p}$ ($A_v = 1$) | | | 0.003 | | % |
| Slew Rate | | | | 4 | | $V/\mu s$ |
| Settling Time to 0.01% | $A_v = 1$, $V_{OUT} = 2V$ step | | | 2.0 | | μs |
| Turn-On Time | $V_{CC} = 0V$ to $3V$ step, $V_{OUT} = V_{CC} / 2$ | | | 1 | | μs |
| \overline{SHDN} Delay | MAX4131-MAX4134, $V_{CC} = 3V$, $V_{OUT} = V_{CC} / 2$ | | Enable | | 1 | μs |
| | | | Disable | | 0.2 | |
| Input Capacitance | | | | 3 | | pF |
| Input Noise Voltage Density | $f = 1kHz$ | | | 22 | | nV/\sqrt{Hz} |
| Input Noise Current Density | $f = 1kHz$ | | | 0.4 | | pA/\sqrt{Hz} |
| Capacitive Load Stability | $A_v = 1$ | | | 160 | | pF |

Single/Dual/Quad, Wide-Bandwidth, Low-Power, Single-Supply, Rail-to-Rail I/O Op Amps

Typical Operating Characteristics

($V_{CC} = +5V$, $V_{EE} = 0V$, $V_{CM} = V_{CC} / 2$, $T_A = +25^\circ C$, unless otherwise noted.)

MAX4130-MAX4134

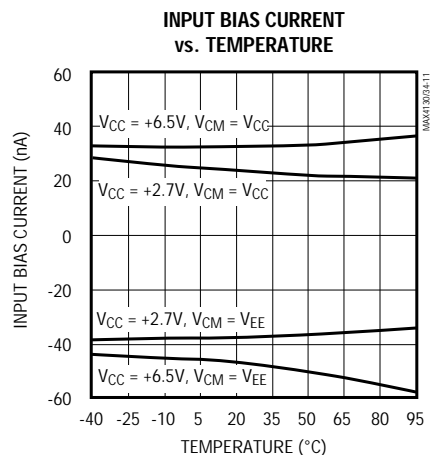
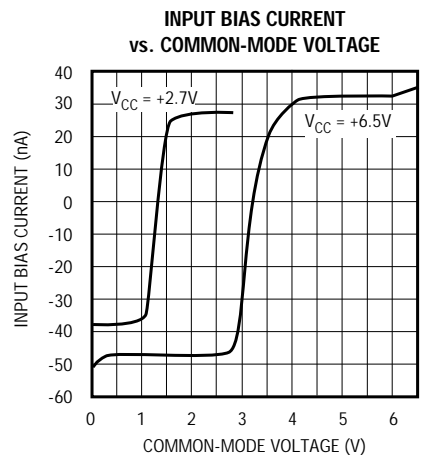
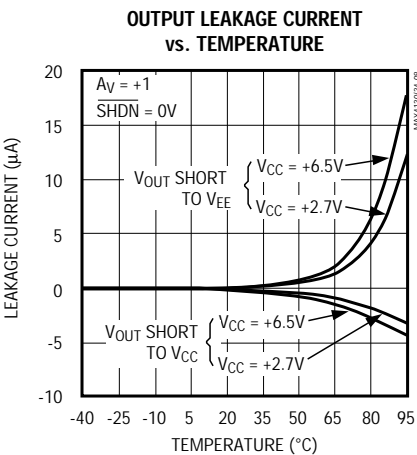
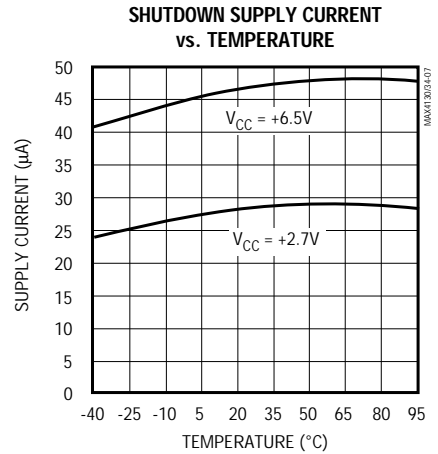
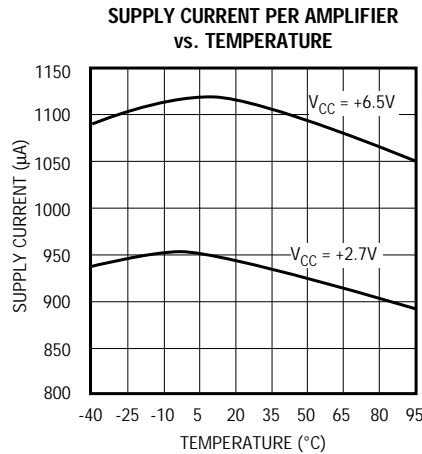
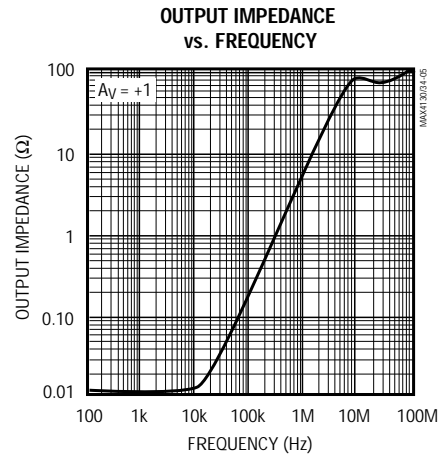
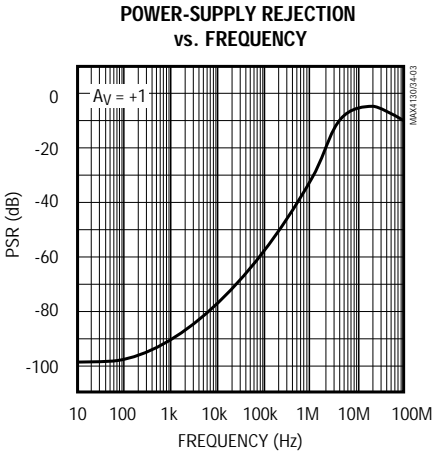
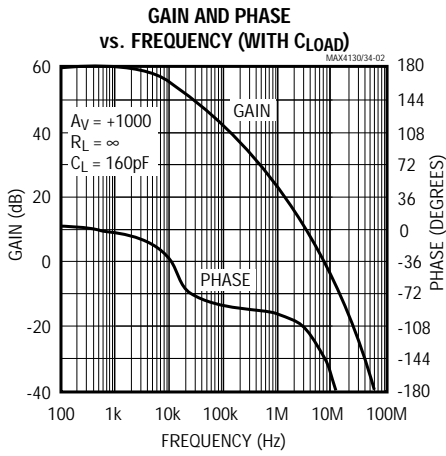
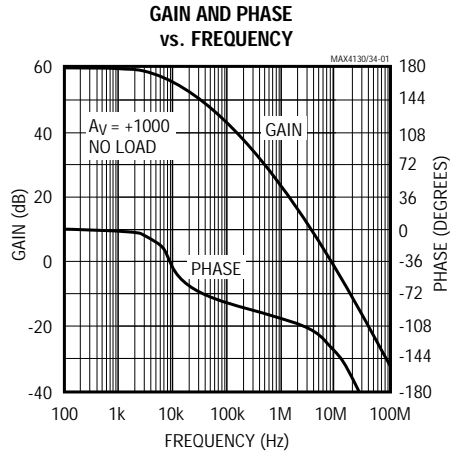

Single/Dual/Quad, Wide-Bandwidth, Low-Power, Single-Supply, Rail-to-Rail I/O Op Amps

Typical Operating Characteristics (continued)

($V_{CC} = +5V$, $V_{EE} = 0V$, $V_{CM} = V_{CC} / 2$, $T_A = +25^\circ C$, unless otherwise noted.)

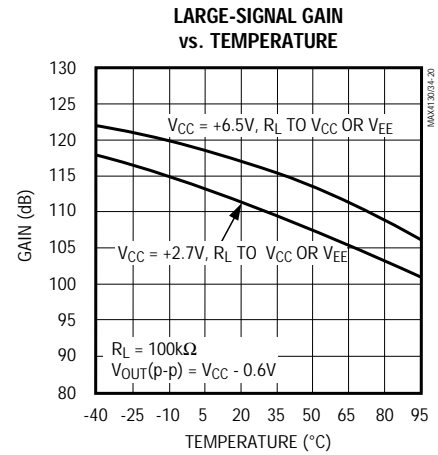
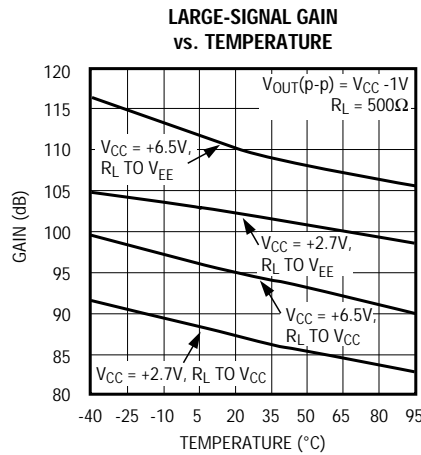
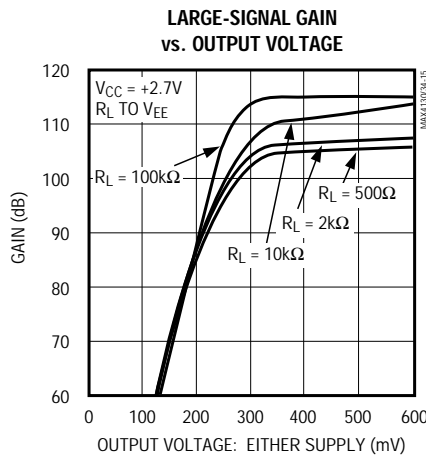
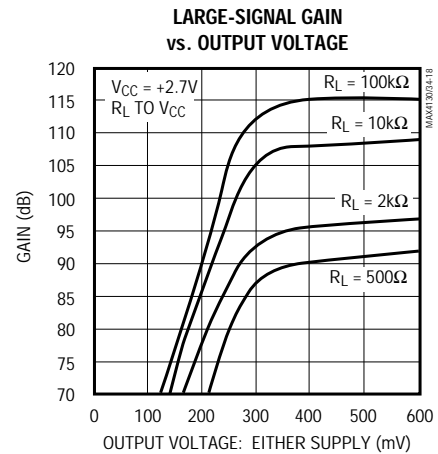
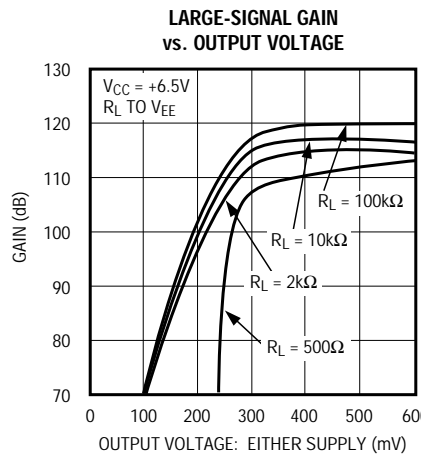
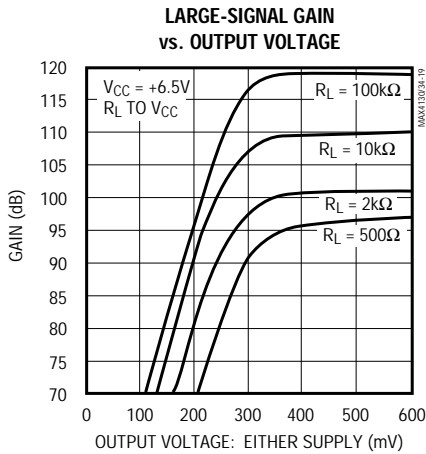
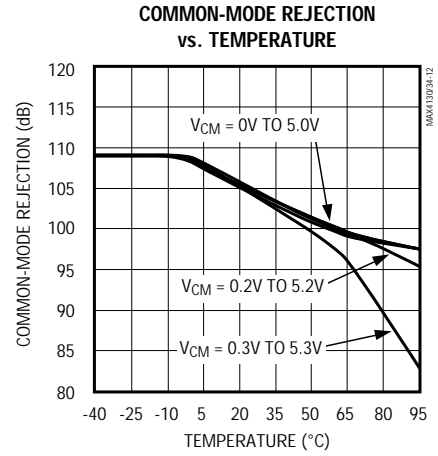
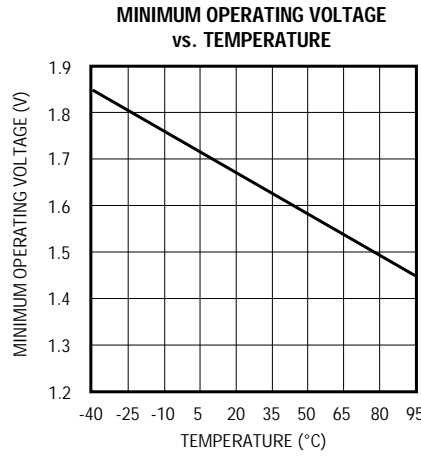
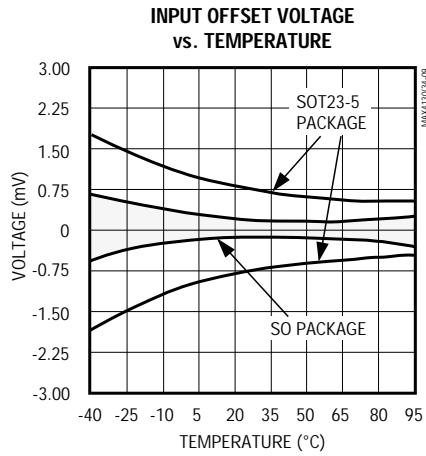

Single/Dual/Quad, Wide-Bandwidth, Low-Power, Single-Supply, Rail-to-Rail I/O Op Amps

MAX4130-MAX4134

Typical Operating Characteristics (continued)

($V_{CC} = +5V$, $V_{EE} = 0V$, $V_{CM} = V_{CC} / 2$, $T_A = +25^\circ C$, unless otherwise noted.)

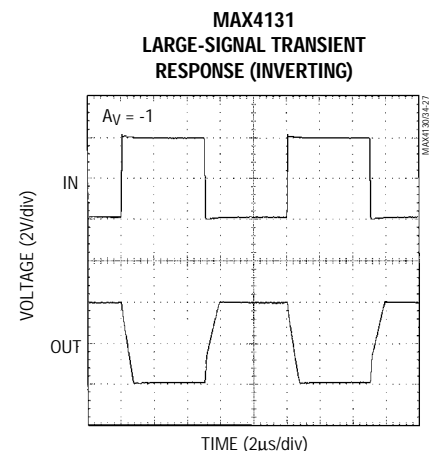
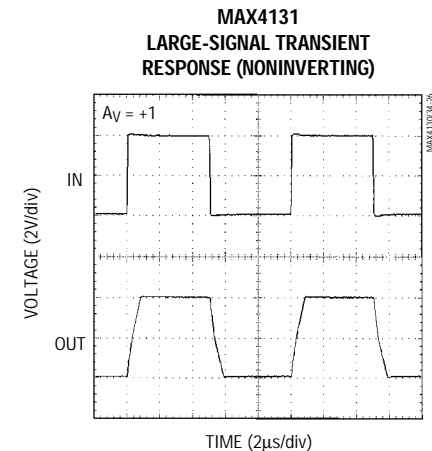
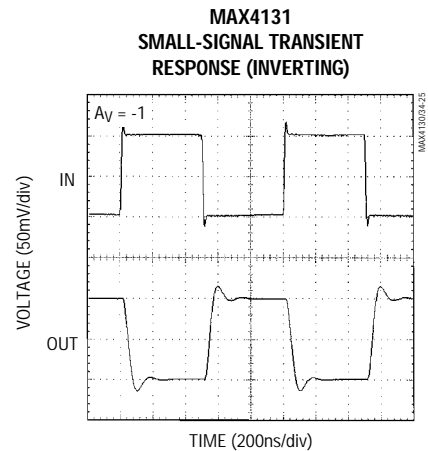
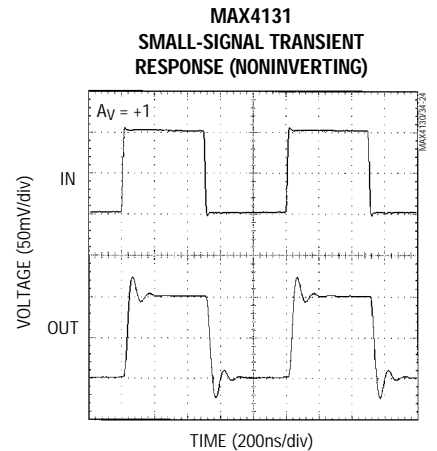
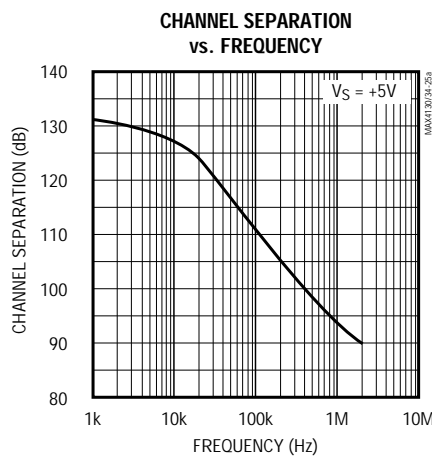
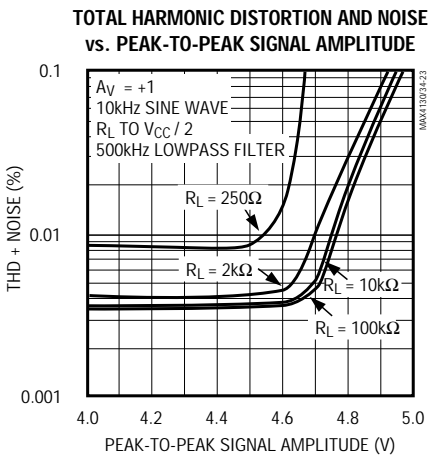
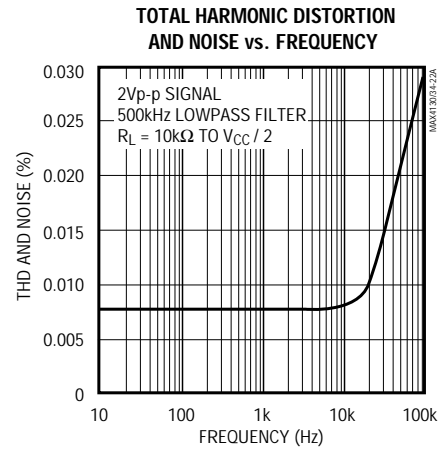
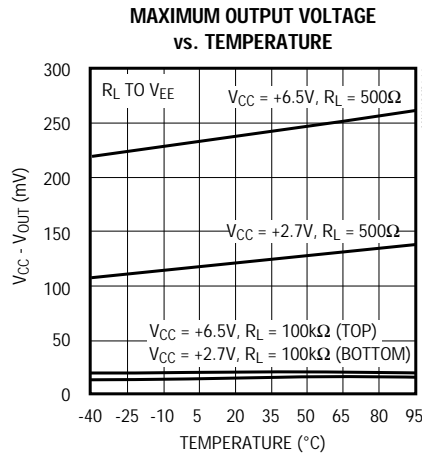
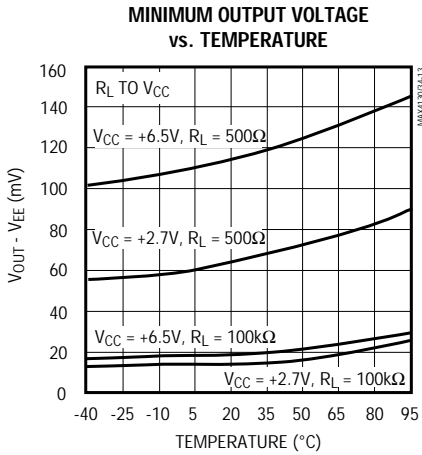

Single/Dual/Quad, Wide-Bandwidth, Low-Power, Single-Supply, Rail-to-Rail I/O Op Amps

Pin Description

| MAX4130 | MAX4131 | MAX4132 | MAX4133 | MAX4134 | NAME | FUNCTION |
|---------|---------|---------|-------------|---------|---|---|
| 1 | 6 | — | — | — | OUT | Output |
| 2 | 4 | 4 | 4 | 11 | VEE | Negative Supply. Ground for single-supply operation. |
| 3 | 3 | — | — | — | IN+ | Noninverting Input |
| 4 | 2 | — | — | — | IN- | Inverting Input |
| 5 | 7 | 8 | 14 | 4 | VCC | Positive Supply |
| — | 1, 5 | — | 5, 7, 8, 10 | — | N.C. | No Connect. Not internally connected. |
| — | 8 | — | — | — | $\overline{\text{SHDN}}$ | Shutdown Control. Tie high or leave floating to enable amplifier. |
| — | — | 1, 7 | 1, 13 | 1, 7 | OUT1, OUT2 | Outputs for amps 1 and 2 |
| — | — | 2, 6 | 2, 12 | 2, 6 | IN1-, IN2- | Inverting Inputs for amps 1 and 2 |
| — | — | 3, 5 | 3, 11 | 3, 5 | IN1+, IN2+ | Noninverting Inputs for amps 1 and 2 |
| — | — | — | 6, 9 | — | $\overline{\text{SHDN1}}$, $\overline{\text{SHDN2}}$ | Shutdown Control, independent for amps 1 and 2. Tie high or leave floating to enable amplifier. |
| — | — | — | — | 8, 14 | OUT3, OUT4 | Outputs for amps 3 and 4 |
| — | — | — | — | 9, 13 | IN3-, IN4- | Inverting Inputs for amps 3 and 4 |
| — | — | — | — | 10, 12 | IN3+, IN4+ | Noninverting Inputs for amps 3 and 4 |

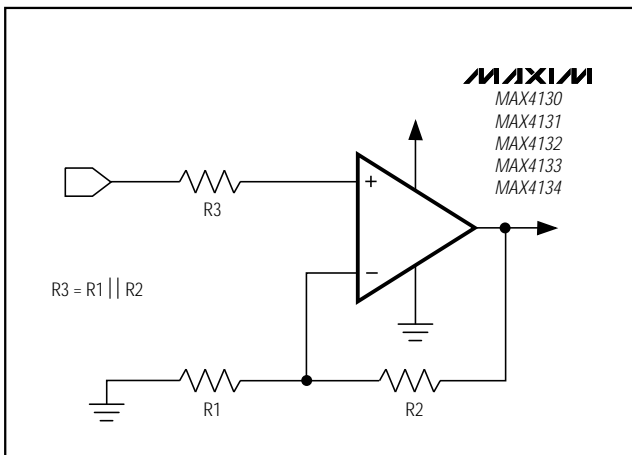

Figure 1a. Reducing Offset Error Due to Bias Current (Noninverting)

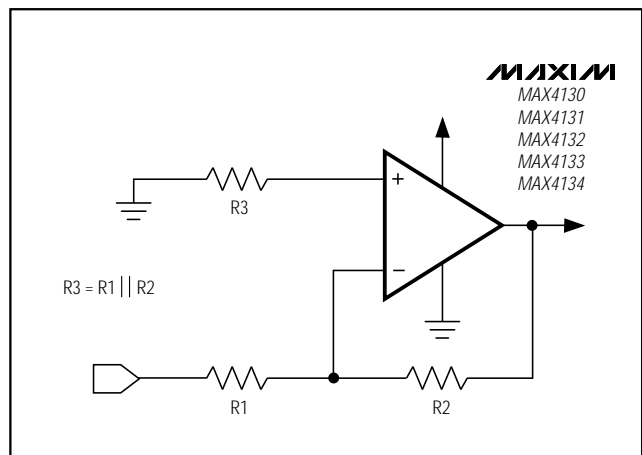

Figure 1b. Reducing Offset Error Due to Bias Current (Inverting)

Single/Dual/Quad, Wide-Bandwidth, Low-Power, Single-Supply, Rail-to-Rail I/O Op Amps

Applications Information

Rail-to-Rail Input Stage

Devices in the MAX4130–MAX4134 family of high-speed amplifiers have rail-to-rail input and output stages designed for low-voltage, single-supply operation. The input stage consists of separate NPN and PNP differential stages that combine to provide an input common-mode range that extends 0.2V beyond the supply rails. The PNP stage is active for input voltages close to the negative rail, and the NPN stage is active for input voltages near the positive rail. The input offset voltage is typically below 200 μ V. The switchover transition region, which occurs near $V_{CC} / 2$, has been extended to minimize the slight degradation in common-mode rejection ratio caused by the mismatch of the input pairs. Their low offset voltage, high bandwidth, and rail-to-rail common-mode range make these op amps excellent choices for precision, low-voltage data-acquisition systems.

Since the input stage switches between the NPN and PNP pairs, the input bias current changes polarity as the input voltage passes through the transition region.

Reduce the offset error caused by input bias currents flowing through external source impedances by matching the effective impedance seen by each input (Figures 1a, 1b). High source impedances, together with input capacitance, can create a parasitic pole that produces an underdamped signal response. Reducing the input impedance or placing a small (2pF to 10pF) capacitor across the feedback resistor improves response.

The MAX4130–MAX4134's inputs are protected from large differential input voltages by 1k Ω series resistors and back-to-back triple diodes across the inputs (Figure 2). For differential input voltages less than 1.8V, input resistance is typically 500k Ω . For differential input voltages greater than 1.8V, input resistance is approximately 2k Ω . The input bias current is given by the following equation:

$$I_{BIAS} = \frac{V_{DIFF} - 1.8V}{2k\Omega}$$

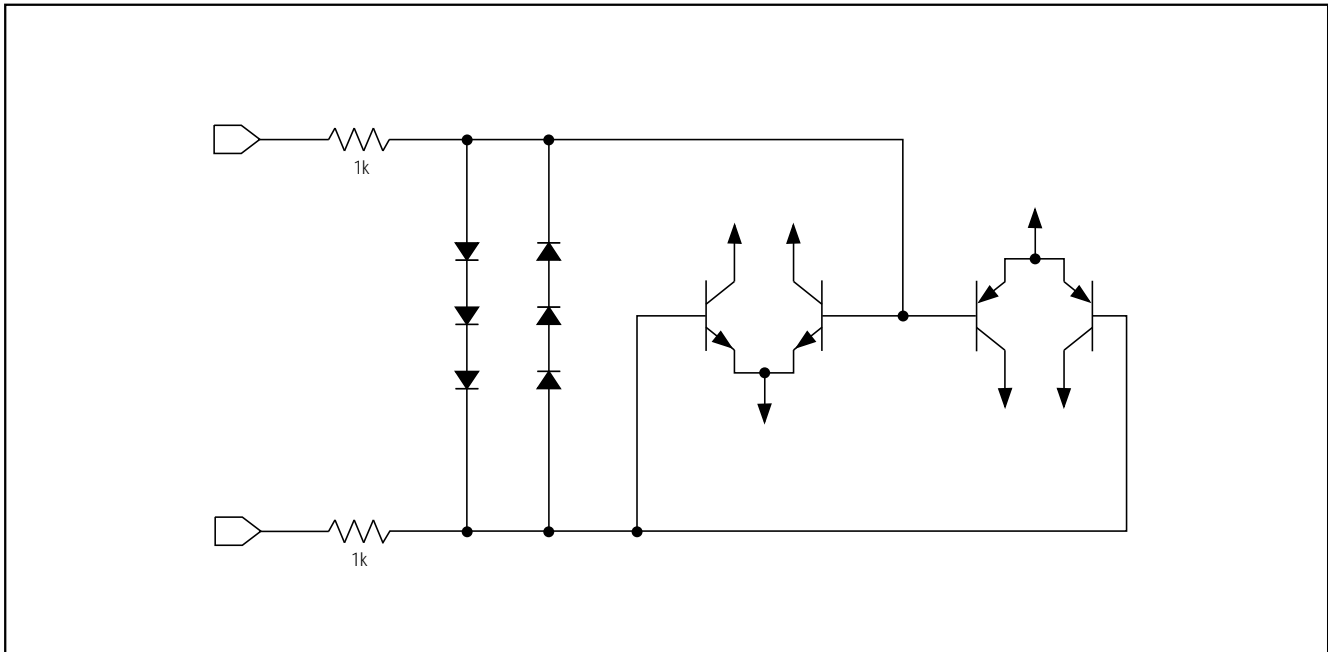

Figure 2. Input Protection Circuit

Single/Dual/Quad, Wide-Bandwidth, Low-Power, Single-Supply, Rail-to-Rail I/O Op Amps

Rail-to-Rail Output Stage

The minimum output voltage is within millivolts of ground for single-supply operation where the load is referenced to ground (V_{EE}). Figure 3 shows the input voltage range and output voltage swing of a MAX4131 connected as a voltage follower. With a +3V supply and the load tied to ground, the output swings from 0.00V to 2.90V. The maximum output voltage swing depends on the load, but will be within 150mV of a +3V supply, even with the maximum load (500Ω to ground).

Driving a capacitive load can cause instability in most high-speed op amps, especially those with low quiescent current. The MAX4130-MAX4134 have a high tolerance for capacitive loads. They are stable with capacitive loads up to 160pF. Figure 4 gives the stable operating region for capacitive loads. Figures 5 and 6 show the response with capacitive loads and the results of adding an isolation resistor in series with the output (Figure 7). The resistor improves the circuit's phase margin by isolating the load capacitor from the op amp's output.

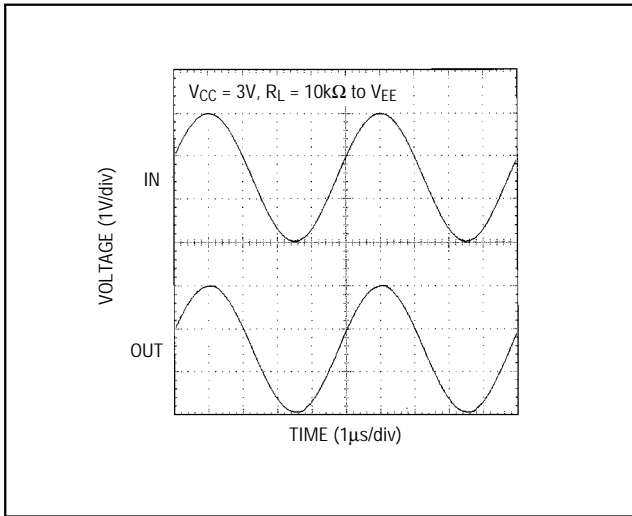

Figure 3. Rail-to-Rail Input/Output Voltage Range

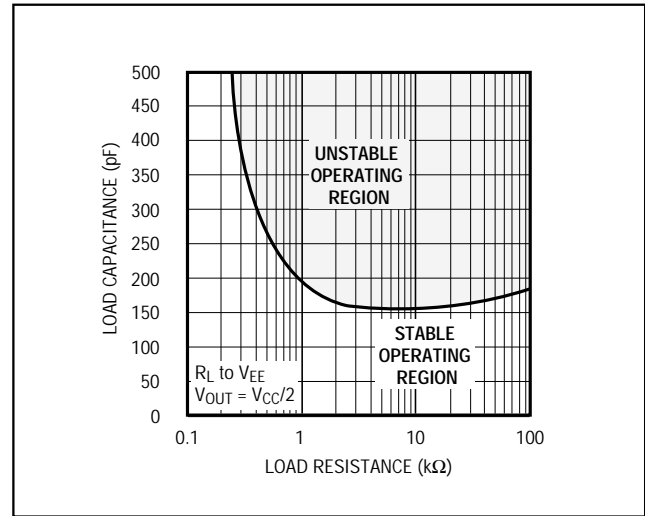

Figure 4. Capacitive-Load Stability

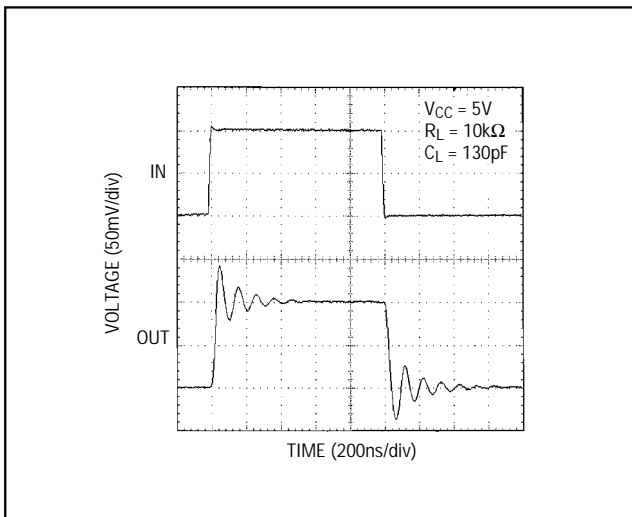

Figure 5. MAX4131 Small-Signal Transient Response with Capacitive Load

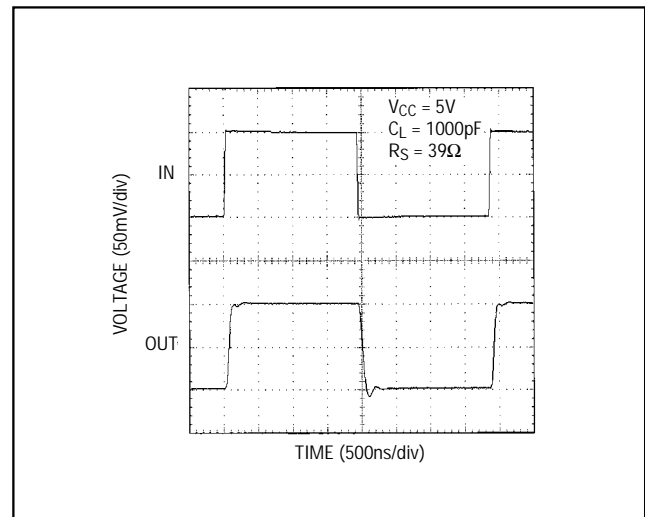

Figure 6. MAX4131 Transient Response to Capacitive Load with Isolation Resistor

Single/Dual/Quad, Wide-Bandwidth, Low-Power, Single-Supply, Rail-to-Rail I/O Op Amps

Power-Up and Shutdown Mode

The MAX4130–MAX4134 amplifiers typically settle within 1 μ s after power-up. Figures 9 and 10 show the output voltage and supply current on power-up, using the test circuit of Figure 8.

The MAX4131 and MAX4133 have a shutdown option. When the shutdown pin ($\overline{\text{SHDN}}$) is pulled low, the supply current drops below 25 μ A per amplifier and the

amplifiers are disabled with the outputs in a high-impedance state. Pulling $\overline{\text{SHDN}}$ high or leaving it floating enables the amplifier. In the dual-amplifier MAX4133, the shutdown functions operate independently. Figures 11 and 12 show the output voltage and supply current responses of the MAX4131 to a shutdown pulse, using the test circuit of Figure 8.

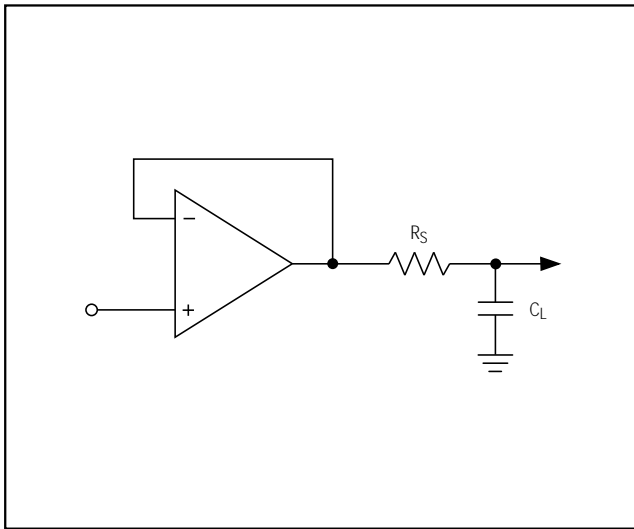

Figure 7. Capacitive-Load Driving Circuit

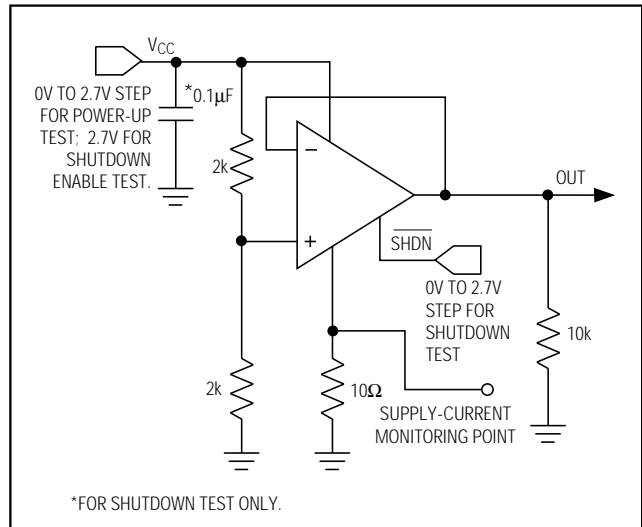

Figure 8. Power-Up/Shutdown Test Circuit

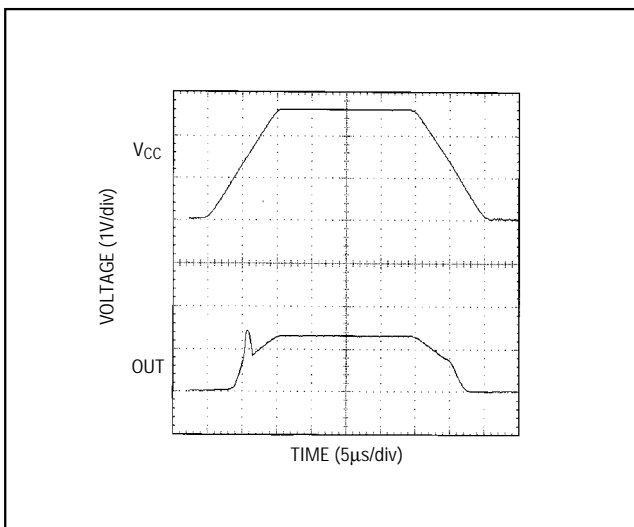

Figure 9. Power-Up Output Voltage

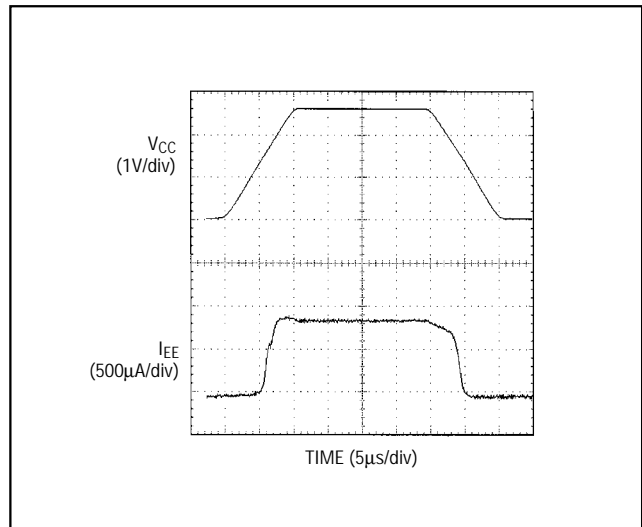

Figure 10. Power-Up Supply Current

Single/Dual/Quad, Wide-Bandwidth, Low-Power, Single-Supply, Rail-to-Rail I/O Op Amps

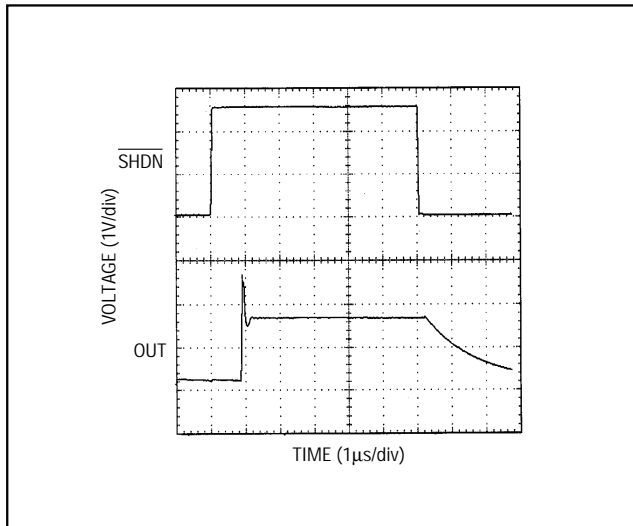

Figure 11. Shutdown Output Voltage

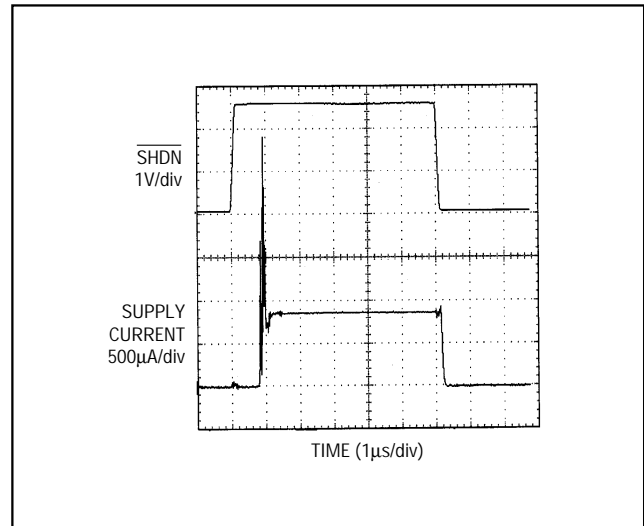

Figure 12. Shutdown Enable/Disable Supply Current

Power Supplies and Layout

The MAX4130-MAX4134 operate from a single +2.7V to +6.5V power supply, or from dual supplies of $\pm 1.35\text{V}$ to $\pm 3.25\text{V}$. For single-supply operation, bypass the power supply with a $0.1\mu\text{F}$ ceramic capacitor in parallel with at least $1\mu\text{F}$. For dual supplies, bypass each supply to ground.

Good layout improves performance by decreasing the amount of stray capacitance at the op amp's inputs and outputs. Decrease stray capacitance by placing external components close to the op amp's pins, minimizing trace lengths and resistor leads.

Single/Dual/Quad, Wide-Bandwidth, Low-Power, Single-Supply, Rail-to-Rail I/O Op Amps

Pin Configurations

MAX4130-MAX4134

TOP VIEW

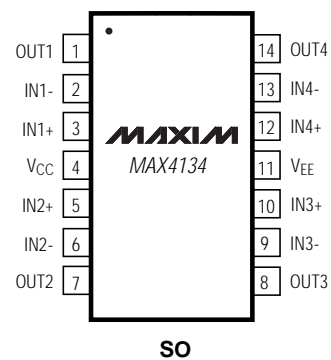
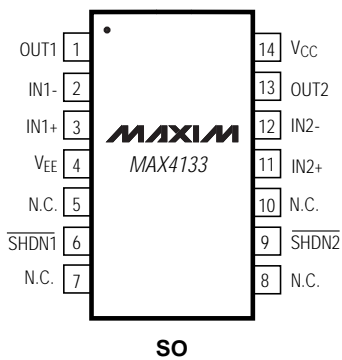
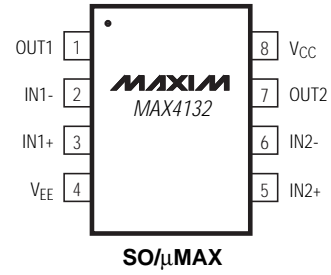
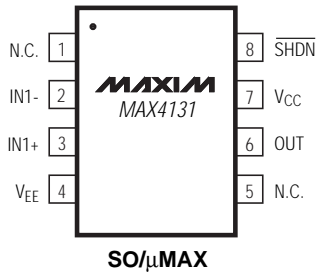
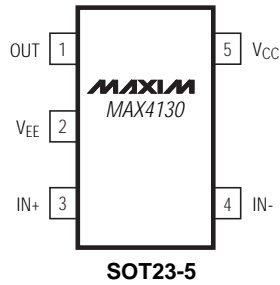

Single/Dual/Quad, Wide-Bandwidth, Low-Power, Single-Supply, Rail-to-Rail I/O Op Amps

Ordering Information (continued)

| PART | TEMP. RANGE | PIN-PACKAGE | SOT TOP MARK |
|------------|----------------|-------------|--------------|
| MAX4132ESA | -40°C to +85°C | 8 SO | — |
| MAX4132EUA | -40°C to +85°C | 8 μ MAX | — |
| MAX4133C/D | 0°C to +70°C | Dice* | — |
| MAX4133ESD | -40°C to +85°C | 14 SO | — |
| MAX4134ESD | -40°C to +85°C | 14 SO | — |

*Dice are specified at $T_A = +25^\circ\text{C}$, DC parameters only.

Chip Information

MAX4130 TRANSISTOR COUNT: 170
 MAX4132 TRANSISTOR COUNT: 340
 MAX4134 TRANSISTOR COUNT: 680

Chip Topographies

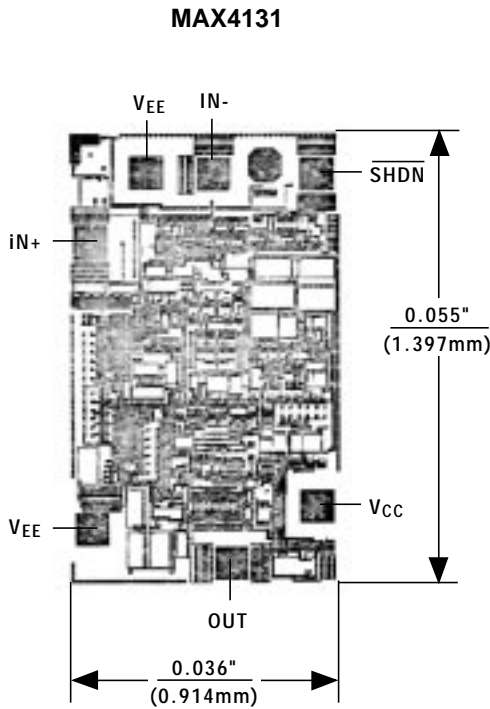

TRANSISTOR COUNT: 170
 SUBSTRATE CONNECTED TO VEE

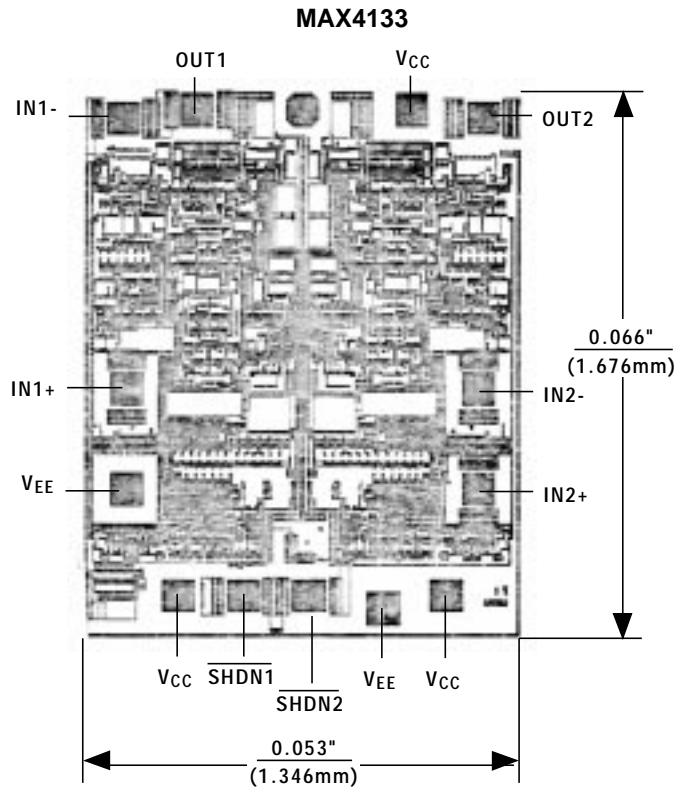

TRANSISTOR COUNT: 340
 SUBSTRATE CONNECTED TO VEE

Single/Dual/Quad, Wide-Bandwidth, Low-Power, Single-Supply, Rail-to-Rail I/O Op Amps

Package Information

MAX4130-MAX4134

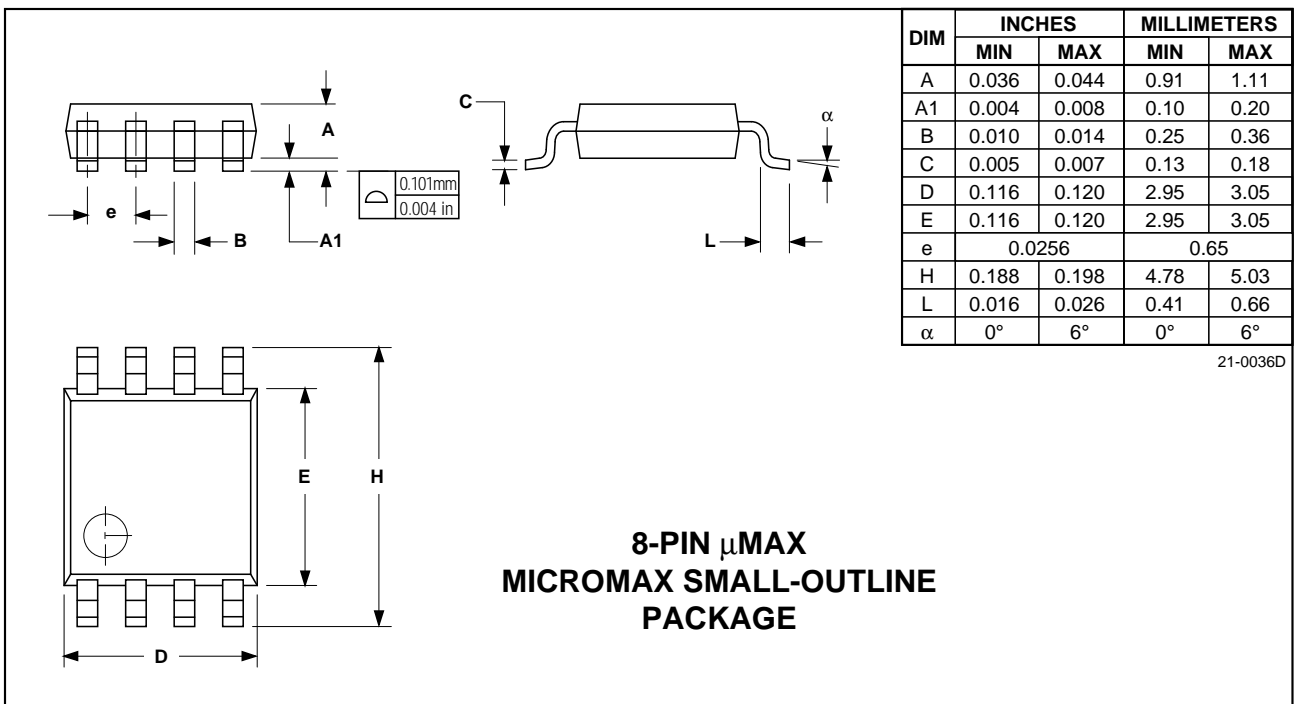
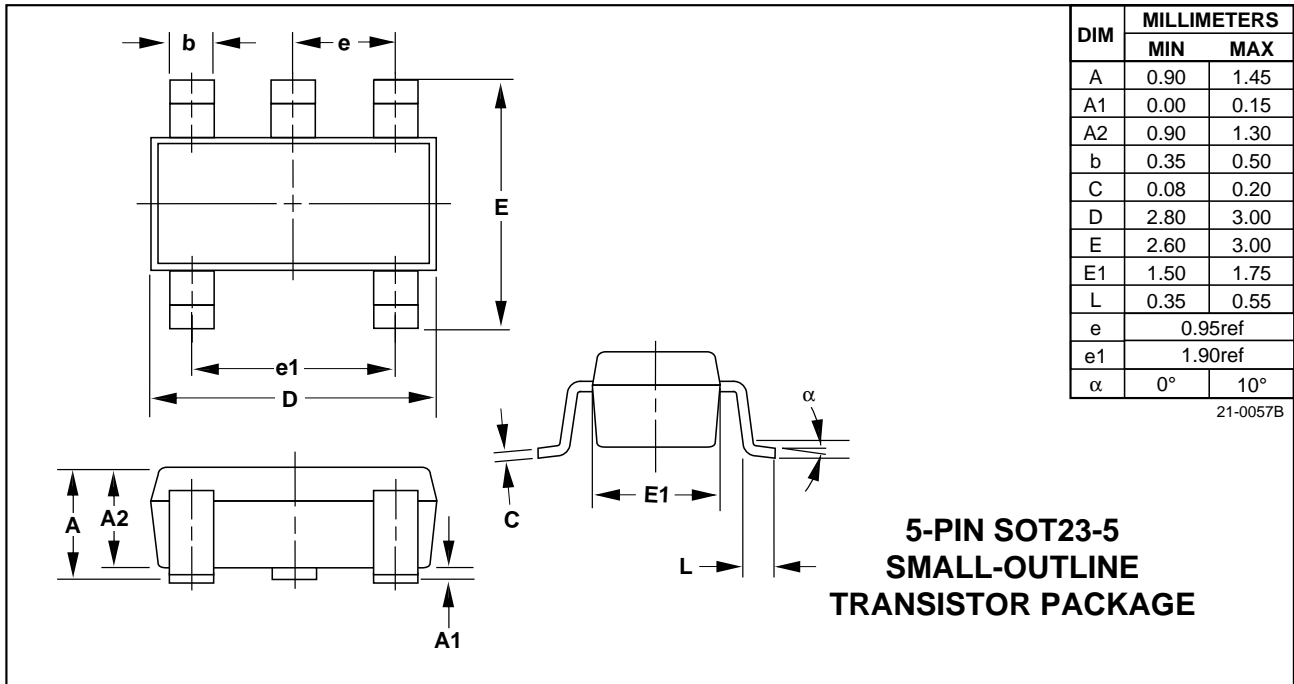

Single/Dual/Quad, Wide-Bandwidth, Low-Power, Single-Supply, Rail-to-Rail I/O Op Amps

Package Information (continued)

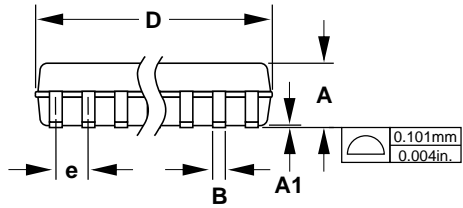

| DIM | INCHES | | MILLIMETERS | |
|-----|--------|-------|-------------|------|
| | MIN | MAX | MIN | MAX |
| A | 0.053 | 0.069 | 1.35 | 1.75 |
| A1 | 0.004 | 0.010 | 0.10 | 0.25 |
| B | 0.014 | 0.019 | 0.35 | 0.49 |
| C | 0.007 | 0.010 | 0.19 | 0.25 |
| E | 0.150 | 0.157 | 3.80 | 4.00 |
| e | 0.050 | | 1.27 | |
| H | 0.228 | 0.244 | 5.80 | 6.20 |
| L | 0.016 | 0.050 | 0.40 | 1.27 |

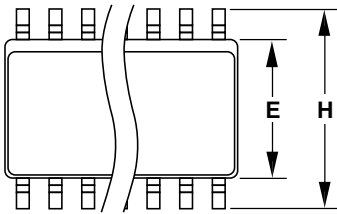

**Narrow SO
SMALL-OUTLINE
PACKAGE
(0.150 in.)**

| DIM | PINS | INCHES | | MILLIMETERS | |
|-----|------|--------|-------|-------------|-------|
| | | MIN | MAX | MIN | MAX |
| D | 8 | 0.189 | 0.197 | 4.80 | 5.00 |
| D | 14 | 0.337 | 0.344 | 8.55 | 8.75 |
| D | 16 | 0.386 | 0.394 | 9.80 | 10.00 |

21-0041A

Maxim cannot assume responsibility for use of any circuitry other than circuitry entirely embodied in a Maxim product. No circuit patent licenses are implied. Maxim reserves the right to change the circuitry and specifications without notice at any time.

16 Maxim Integrated Products, 120 San Gabriel Drive, Sunnyvale, CA 94086 408-737-7600