

MAXIM

Calibrated 12-Bit A/D Converter

MX7578

General Description

The MX7578 is a complete, calibrated 12-bit A/D converter (ADC) which includes a conversion clock. Internal calibration circuitry maintains true 12-bit performance over the full operating temperature range without external adjustments. In addition, each conversion includes an auto-zero cycle which reduces zero errors to typically below 100 μ V.

CHIP SELECT, READ, and WRITE inputs are included for easy microprocessor interfacing without additional logic. 2-byte, 12-bit conversion data is provided over an 8-bit three-state output bus. Either byte may be read first. Two converter busy flags facilitate polling of the converter's status.

The MX7578's analog input range is 0V to +5V when using a +5V reference. Refer to Maxim's MAX178 data sheet for a plug-in upgrade with track/hold and internal reference.

Applications

- Digital-Signal Processing
- Audio and Telecom Processing
- High-Speed Data Acquisition
- High-Accuracy Process Control

Features

- ◆ Continuous Transparent Calibration of Offset and Gain
- ◆ True 12-Bit Performance without Adjustments
- ◆ Zero Error Typically <100 μ V
- ◆ Standard Microprocessor Interface
- ◆ 24-Pin DIP/Wide SO and 28-Pin PLCC Packages

Ordering Information

| PART | TEMP. RANGE | PIN-PACKAGE |
|------------|-----------------|----------------|
| MX7578KN | 0°C to +70°C | 24 Plastic DIP |
| MX7578KCWG | 0°C to +70°C | 24 Wide SO** |
| MX7578KP | 0°C to +70°C | 28 PLCC |
| MX7578K/D | 0°C to +70°C | Dice** |
| MX7578KEWG | -40°C to +85°C | 24 Wide SO** |
| MX7578BQ | -40°C to +85°C | 24 CERDIP* |
| MX7578BD | -40°C to +85°C | 24 Ceramic SB |
| MX7578TQ | -55°C to +125°C | 24 CERDIP* |
| MX7578TD | -55°C to +125°C | 24 Ceramic SB |

* Maxim reserves the right to ship Ceramic SB in lieu of CERDIP packages.

** Consult factory.

Pin Configurations

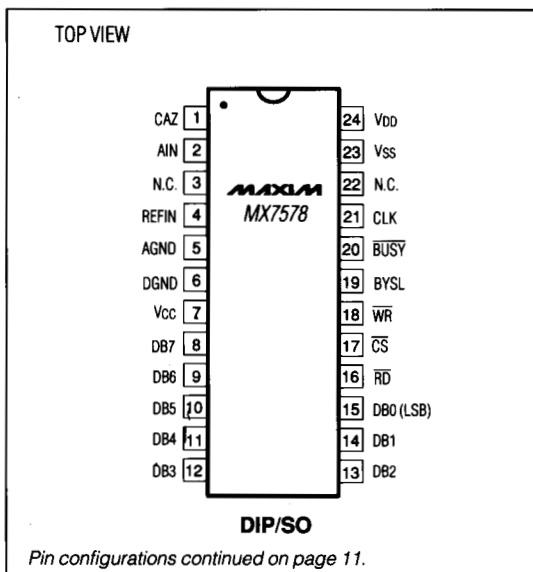

Functional Diagram

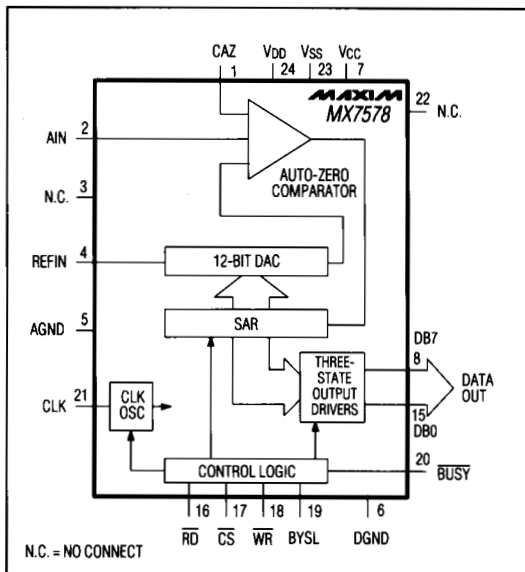

Calibrated 12-Bit A/D Converter

MX7578

ABSOLUTE MAXIMUM RATINGS

| | | | |
|--------------------------------|------------------------------|---------------------------------------|-----------------|
| V _{DD} to DGND | -0.3V, +17V | Operating Temperature Range | |
| V _{SS} to DGND | +0.3V, -7V | MX7578KCWG/KD/KN/KP | 0°C to +70°C |
| AGND to DGND | -0.3V, REFIN +0.3V | MX7578BD/BQ/KEWG | -40°C to +85°C |
| V _{CC} to DGND | -0.3V, +7V | MX7578TD/TQ | -55°C to +125°C |
| REFIN to AGND | -0.3V, V _{DD} +0.3V | Power Dissipation (any Package) | |
| AIN to AGND | -0.3V, V _{DD} +0.3V | to +75°C | 1000mW |
| Digital Input Voltage to DGND | -0.3V, V _{DD} +0.3V | Derate above +75°C by | 10mW/°C |
| Digital Output Voltage to DGND | -0.3V, V _{DD} +0.3V | Storage Temperature | -65°C to +150°C |
| | | Lead Temperature (Soldering, 10 sec.) | +300°C |

Stresses beyond those listed under "Absolute Maximum Ratings" may cause permanent damage to the device. These are stress ratings only, and functional operation of the device at these or any other conditions beyond those indicated in the operational sections of the specifications is not implied. Exposure to absolute maximum rating conditions for extended periods may affect device reliability.

ELECTRICAL CHARACTERISTICS

(V_{DD} = +15V, V_{CC} = +5V, V_{SS} = -5V, REFIN = +5.0V, f_{CLK} = 140kHz external, all specifications T_A = T_{MIN} to T_{MAX}, unless otherwise noted.)

| PARAMETER | SYMBOL | CONDITIONS | MIN | TYP | MAX | UNITS |
|---------------------------------|--------------------|---|-----|--------|-----------|--------|
| ACCURACY | | | | | | |
| Resolution | | | 12 | | | Bits |
| Total Unadjusted Error (Note 1) | TUE | | | | ±1 | LSB |
| Differential Nonlinearity | DNL | No missing codes guaranteed | | | ± | LSB |
| Full-Scale Error (Gain Error) | | | | | ±1/4 | LSB |
| Full-Scale Tempco | | | | 0.25 | | ppm/°C |
| Zero Error | | | | | ±1/4 | LSB |
| Zero Error Tempco | | | | 0.25 | | ppm/°C |
| ANALOG INPUT | | | | | | |
| Input Voltage Range | | V _{REF} = +5V | 0 | | +5 | V |
| On-Channel Input Capacitance | C _{AIN} | | | 8 | | pF |
| Input Leakage Current | I _{AIN} | A _{IN} = 0V to +5V: T _A = +25°C T _A = T _{MIN} to T _{MAX} | | | 10 100 | nA |
| REFERENCE INPUT | | | | | | |
| REFIN Range | V _{REFIN} | For specified performance | | +5 ±5% | | V |
| | | Degraded transfer accuracy | +4 | | +6 | |
| REFIN Input Current | | REFIN = +5.0V | | | 1.0 | mA |

Calibrated 12-Bit A/D Converter

MX7578

ELECTRICAL CHARACTERISTICS (continued)

(V_{DD} = +15V, V_{CC} = +5V, V_{SS} = -5V, REFIN = +5.0V, f_{CLK} = 140kHz external, all specifications T_A = T_{MIN} to T_{MAX}, unless otherwise noted.)

| PARAMETER | SYMBOL | CONDITIONS | MIN | TYP | MAX | UNITS |
|---|------------------|---|------|-------|-----------|-------|
| LOGIC INPUTS (RD, CS, WR, BYSL) | | | | | | |
| Input High Voltage | V _{IH} | V _{CC} = +5V ±5% | +2.4 | | | V |
| Input Low Voltage | V _{IL} | V _{CC} = +5V ±5% | | | +0.8 | V |
| Input Current | I _{IN} | V _{IN} = 0 to V _{CC} ; T _A = +25°C T _A = T _{MIN} to T _{MAX} | | | ±1 ±10 | μA |
| Input Capacitance | C _{IN} | (Note 2) | | | 10 | pF |
| CLOCK | | | | | | |
| Input High Voltage | V _{IH} | V _{CC} = +5V ±5% | +3.0 | | | V |
| Input Low Voltage | V _{IL} | V _{CC} = +5V ±5% | | | +0.8 | V |
| Input High Current | I _{IH} | V _{CC} = +5V ±5% | | | +1.5 | mA |
| Input Low Current | I _{IL} | V _{CC} = +5V ±5% | | | ±10 | μA |
| LOGIC OUTPUTS (DB0-DB7, BUSY) | | | | | | |
| Output High Voltage | V _{OH} | V _{CC} = +5V ±5%, I _{SOURCE} = 200μA | +4.0 | | | V |
| Output Low Voltage | V _{OL} | V _{CC} = +5V ±5%, I _{SINK} = 1.6mA | | | +0.4 | V |
| Floating State Leakage Current (DB0-DB7) | I _{LKG} | V _{OUT} = 0V to V _{CC} | | | ±1 | μA |
| Floating State Output Capacitance (DB0-DB7) | C _{OUT} | (Note 2) | | | 15 | pF |
| CONVERSION TIME (Note 3) | | | | | | |
| With External Clock | | f _{CLK} = 140kHz | 100 | | | μs |
| With Internal Clock | | T _A = +25°C; Use clock components shown in figure 6. | 100 | | 150 | μs |
| POWER REQUIREMENTS (Note 4) | | | | | | |
| Power-Supply Voltage | V _{DD} | | | +15 | | V |
| | V _{SS} | | | -5 | | |
| | V _{CC} | | | +5 | | |
| Power-Supply Current | I _{DD} | | | 5.5 | 7.5 | mA |
| | I _{SS} | | | 5.0 | 7.5 | |
| | I _{CC} | V _{IN} = V _{IL} or V _{IH} | | 0.1 | 1.0 | |
| V _{DD} Supply Rejection | | V _{DD} = +14.25V to +15.75V, V _{SS} = -5V | | ±0.03 | | LSB |
| V _{SS} Supply Rejection | | V _{SS} = -4.75V to -5.25V, V _{DD} = +15V | | ±0.02 | | LSB |

Note 1: Includes: Full-Scale Error, Offset Error, Relative Accuracy.

Note 2: Guaranteed by design.

Note 3: Auto-zero cycle time included in Conversion Time.

Note 4: Power-supply current is measured when MX7578 is inactive ($\overline{CS} = \overline{WR} = \overline{RD} = \overline{BUSY} = \text{High}$).

Calibrated 12-Bit A/D Converter

MX7578

TIMING CHARACTERISTICS (Note 5, Figures 1 and 2)

(V_{DD} = +15V, V_{CC} = +5V, V_{SS} = -5V, REF_{IN} = +5.0V.)

| PARAMETER | SYMBOL | CONDITIONS | T _A = +25°C | | | T _A = -40°C to +85°C | | | T _A = -55°C to +125°C | | | UNITS |
|--|----------------------|--------------------------|------------------------|-----|-----|---------------------------------|-----|-----|----------------------------------|-----|-----|-------|
| | | | MIN | TYP | MAX | MIN | TYP | MAX | MIN | TYP | MAX | |
| \overline{CS} to \overline{WR} Setup Time | t ₁ | | 0 | | | 0 | | | 0 | | | ns |
| \overline{WR} Pulse Width | t ₂ (INT) | Internal Clock Operation | 200 | | | 240 | | | 280 | | | ns |
| \overline{WR} Pulse Width | t ₂ (EXT) | External Clock Operation | 10 | | | 10 | | | 10 | | | μs |
| \overline{CS} to \overline{WR} Hold Time | t ₃ | | 0 | | | 0 | | | 0 | | | ns |
| \overline{WR} to \overline{BUSY} Propagation Delay | t ₄ | | | 80 | 200 | | 95 | 250 | | 110 | 300 | ns |
| \overline{BUSY} to \overline{CS} Setup Time | t ₅ | (Note 2) | 0 | | | 0 | | | 0 | | | ns |
| \overline{CS} to \overline{RD} Setup Time | t ₆ | | 0 | | | 0 | | | 0 | | | ns |
| \overline{RD} Pulse Width | t ₇ | | 200 | | | 240 | | | 280 | | | ns |
| \overline{CS} to \overline{RD} Hold Time | t ₈ | | 0 | | | 0 | | | 0 | | | ns |
| \overline{BYSL} to \overline{RD} Setup Time | t ₉ | | 50 | | | 50 | | | 50 | | | ns |
| \overline{BYSL} to \overline{RD} Hold Time | t ₁₀ | | 0 | | | 0 | | | 0 | | | ns |
| \overline{RD} to Valid Data (Note 6) | t ₁₁ | (Bus Access Time) | | 60 | 200 | | 75 | 240 | | 85 | 280 | ns |
| \overline{RD} to Three-State Output (Note 7) | t ₁₂ | (Bus Relinquish Time) | 20 | | 130 | 20 | | 160 | 20 | | 180 | ns |

Note 5: Data is timed from V_{OH}, V_{OL}; all input control signals are timed from a voltage level of +1.6V and specified with t_r = t_f = 20ns (10% to 90% of +5V).

Note 6: t₁₁, the time required for an output to cross 0.8V or 2.4V, is measured with the load circuits of Figure 3.

Note 7: t₁₂, the time required for the data lines to change 0.5V, is measured with the load circuits of Figure 4.

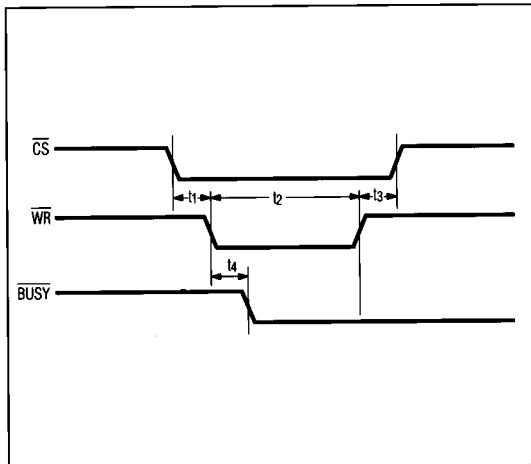

Figure 1. Start Cycle Timing

Calibrated 12-Bit A/D Converter

MX7578

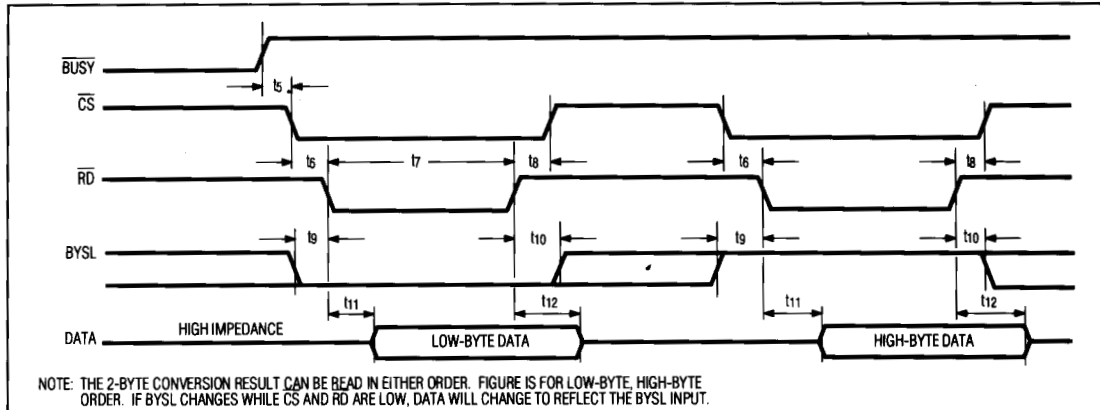

Figure 2. Read Cycle Timing

Pin Description

| PIN | NAME | FUNCTION |
|------|---------|---|
| 1 | CAZ | Auto-Zero Capacitor Input. Connect other end of capacitor to AGND. |
| 2 | AIN | Analog Input |
| 3 | N.C. | No Connect |
| 4 | REFIN | Voltage Reference Input. The MX7578 is specified with REFIN = +5.0V. |
| 5 | AGND | Analog Ground |
| 6 | DGND | Digital Ground |
| 7 | VCC | Logic Supply. Digital inputs and outputs are TTL compatible for VCC = +5V. |
| 8-15 | DB0-DB7 | Three-State Data Outputs. Active when CS and RD are brought low. Individual pin functions depend upon BYTE SELECT (BYSL) input. |

| DATA BUS OUTPUT, CS, RD = LOW | | |
|-------------------------------|---------------|------------|
| PIN | BYSL = HIGH | BYSL = LOW |
| 8 | BUSY (Note 8) | DB7 |
| 9 | LOW (Note 9) | DB6 |
| 10 | LOW (Note 9) | DB5 |
| 11 | LOW (Note 9) | DB4 |
| 12 | DB11 (MSB) | DB3 |
| 13 | DB10 | DB2 |
| 14 | DB9 | DB1 |
| 15 | DB8 | DB0 (LSB) |

| PIN | NAME | FUNCTION |
|-----|------|--|
| 16 | RD | READ Input. Used with CS to enable the three-state data outputs. RD is active low. |
| 17 | CS | CHIP SELECT Input. Used with either RD or WR for control. CS is active low. |
| 18 | WR | WRITE Input. In combination with CS, this active low signal starts a new conversion. The minimum WR pulse width is t ₂ (INT) when the MX7578 is driven by the on-chip clock. When an external clock is used, the minimum WR pulse width, t ₂ (EXT), must include the auto-zero cycle time. |
| 19 | BYSL | BYTE SELECT. BYSL selects high- or low-byte output during a data READ operation. (RD, CS = low). See pins 8-15. |
| 20 | BUSY | Converter Status. BUSY is only low during conversion. |
| 21 | CLK | CLOCK Input. Internal clock operation typically results in 120μs conversion time (Figure 6). This can be shortened by using an external 74HC clock source (Figure 8). |
| 22 | N.C. | No Connect |
| 23 | VSS | Negative Supply Voltage, -5V |
| 24 | VDD | Positive Supply Voltage, +15V |

Note 8: High during a conversion, BUSY is a converter status flag.
Note 9: When BYSL is high, pins 9-11 output a logic low. The 12-bit digital result is in DB11-DB0. DB11 is the MSB.

Calibrated 12-Bit A/D Converter

Detailed Operation Operating Information

Figure 5 shows an operational diagram for the MX7578. The only required passive components are a hold capacitor (CAZ) and timing components (RCLK, CCLK1, CCLK2) for the on-chip clock oscillator. Only CAZ is required when the MX7578 is used with an external clock. Individual pin functions are listed in the Pin Description table.

On-Chip Clock Operation

Figure 6 shows the clock circuitry for on-chip clock operation. Operating waveforms are shown in Figure 7.

The MX7578 is in the auto-zero mode when a conversion is complete (BUSY = High). When a new conversion is initiated (\overline{CS} = Low, \overline{WR} = Low) CAZ charges to a level equal to the analog input voltage minus the input offset voltage of the auto-zero comparator. The auto-zero cycle must extend at least 10 μ s into the new conversion.

When using an internal clock, it is not necessary for \overline{WR} to remain low for 10 μ s since auto-zero timing is automatically set by the MX7578. This is achieved by switching a constant current load across the clock capacitors, CCLK1 and CCLK2, causing the voltage at the CLK input pin to slowly

decay from VCC (Figure 7). This occurs after \overline{WR} returns high. The Schmitt trigger circuit monitoring the voltage on the CLK input ends the auto-zero cycle when its low-input trigger level is reached. At this point, the constant current load across the clock capacitors is removed allowing them to charge towards VCC via RCLK. When the voltage at the CLK input reaches the high-trigger level, the constant current load is replaced across CCLK1 and CCLK2. The most significant bit (MSB) decision is made when the low-trigger level is reached. This cycle repeats itself 12 times to provide 12 clock pulses for the conversion cycle. The circuit arrangement of Figure 6 provides the relatively slow auto-zero cycle time at the beginning of a conversion while allowing the clock oscillator to speed up once the auto-zero cycle is complete.

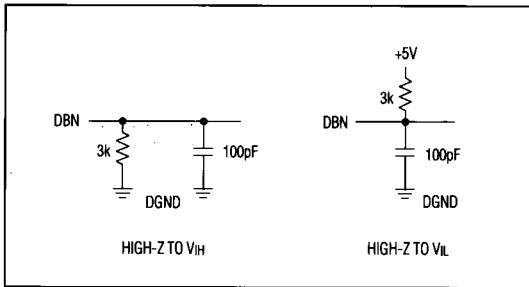

Figure 3. Load Circuits for Access Time Test (t_{11})

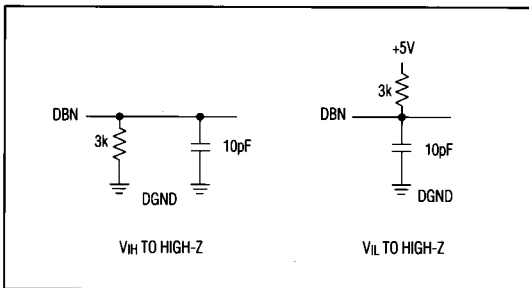

Figure 4. Load Circuits for Output Float Delay Test (t_{12})

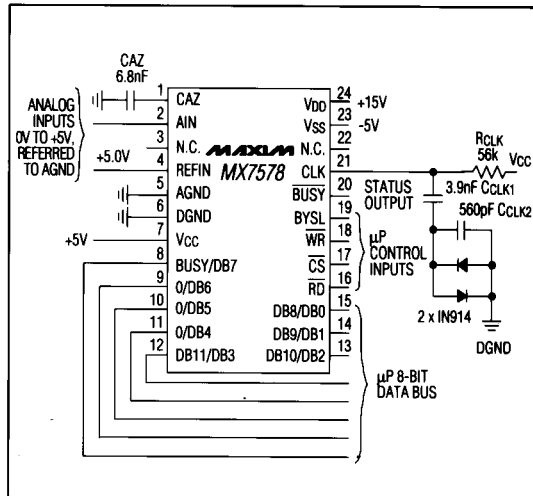

Figure 5. MX7578 Operational Diagram

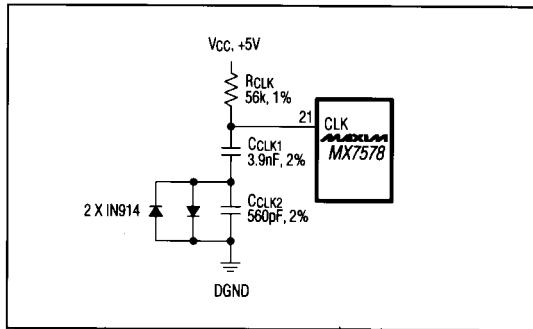

Figure 6. Circuitry Required for Internal Clock Operation

Calibrated 12-Bit A/D Converter

MX7578

Reading Data

The 12-bit conversion result and the converter status flag are accessible over an 8-bit data bus. Data is available from the MX7578 with the least significant bit (LSB) right-justified. Two read operations are needed. The Byte Select (BYSL) input determines which byte is to be read first, 8 LSBs or 4 MSBs plus status flag.

It is necessary to wait for the end of a conversion to obtain valid 12-bit data from the MX7578's successive approximation register (SAR). If a read operation is performed during a conversion, the MX7578 will dump the existing contents of the SAR onto the data bus. There are three different methods that ensure 12-bit data will be read correctly:

1. Insert a software delay longer than the ADC conversion time between the conversion start and the data read operations.
2. $\overline{\text{BUSY}}$ is low during conversion and high at conversion end. Use this signal as an interrupt to the microprocessor.
3. Poll the converter status flag, $\overline{\text{BUSY}}$, at user-defined intervals after a conversion start. The status flag is available on the DB7 pin during a high-byte **READ**. The flag is the left-most bit and can be shifted directly into the microprocessor's carry flag for testing. $\overline{\text{BUSY}}$ is high during a conversion.

A write operation to the MX7578 during a conversion will restart the conversion.

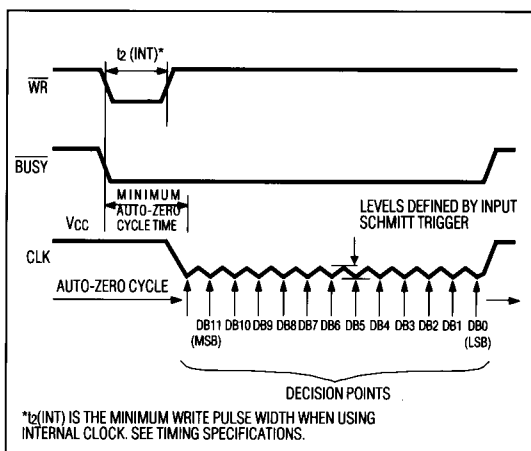

Figure 7. Operating Waveform – Internal Clock

External Clock Operation

For external clock operation, the CLK input is driven with a 74HC compatible clock source (Figure 8). RCLK, CCLK1 and CCLK2 are no longer required. To provide the minimum auto-zero cycle time of 10 μ s, the $\overline{\text{WR}}$ pulse width must be extended to the minimum $\overline{\text{WR}}$ pulse width, $t_2(\text{EXT})$, since this is not provided automatically when using an external clock (Figure 9). It is essential that the $\overline{\text{CS}}$ input remain valid throughout the extended $\overline{\text{WR}}$ pulse width.

Since the MSB decision is made during the second falling edge of the clock input after $\overline{\text{WR}}$ returns high, the external clock source need not be synchronized with the extended $\overline{\text{WR}}$ pulse width.

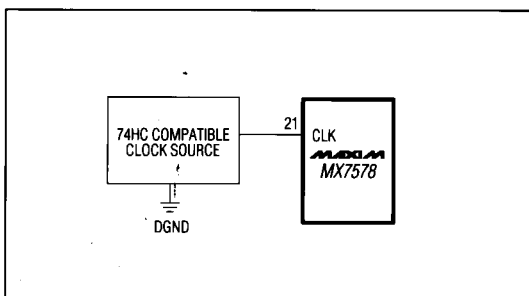

Figure 8. External Clock Operation

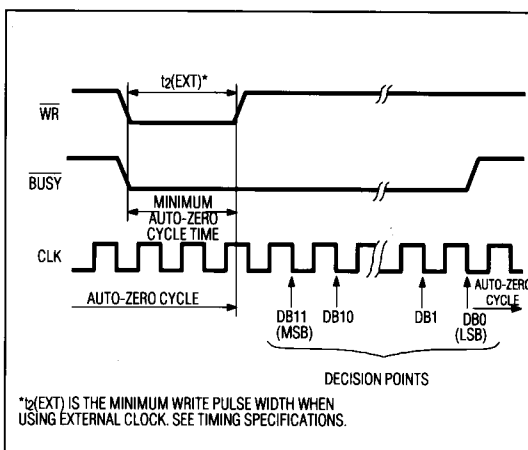

Figure 9. Operating Waveform – External Clock

Calibrated 12-Bit A/D Converter

Application Hints

Auto-zero Capacitor (CAZ)

The auto-zero capacitor (CAZ) (Figure 5) must be a low-leakage, low-dielectric absorption type such as polypropylene, polystyrene, or teflon. Connect the outside foil of CAZ to AGND to minimize noise. CAZ should be between 2.2nF and 6.8nF.

Clock

Series connected capacitors, CCLK1 and CCLK2, generate clock cycles by charging through an external resistor, RCLK, and discharging internally through a switch. Figure 10 shows typical conversion time vs. temperature when using the MX7578's on-chip clock. Due to variations in manufacturing, the actual operating frequency can differ from chip-to-chip by up to 20%. For this reason, it is suggested that an external clock be used under the following situations:

1. Applications needing a conversion time within 20% of 100µs, the shortest conversion time allowable for specified accuracy.
2. Applications that cannot accept conversion time variations, which may result from internal clock variations.

The internal clock may be adjusted by exchanging the RCLK resistor with a 50kΩ potentiometer in series with a 22kΩ resistor (Figure 6). Reducing the value of RCLK from 56kΩ to 47kΩ decreases the conversion time by approximately 15µs at room temperature.

Analog Input

The high-impedance analog input, AIN, allows simple analog interfacing. Signal sources from 0V to +5V may be connected directly to AIN without extra buffering for source impedances up to 5kΩ (Figure 11). The input/output transfer characteristic and transition points for this

input signal range are demonstrated in Figure 12 and Table 1. The MX7578 transfer characteristic transition points occur on integer multiples of 1LSB. The output code is natural binary, with: 1LSB = (Full Scale (FS)) / 4096 = (5/4096)V = 1.22mV.

For signal ranges other than 0V to +5V, use resistor divider networks to provide 0V to +5V signal ranges at the MX7578 input pins. Figure 13 shows a divider network for a 0V to +10V signal range. Resistors should be of the same type and manufacturer to ensure matched temperature coefficients. The source impedance must now be as low as possible since it adds to the resistor divider impedance. The full-scale error created by source impedance R_s is: $R_s / (R_1 + R_2 + R_s)$.

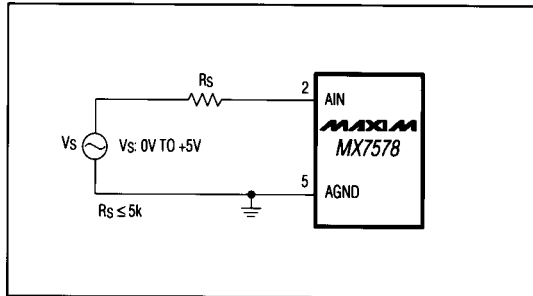

Figure 11. Unipolar 0V to +5V Operation

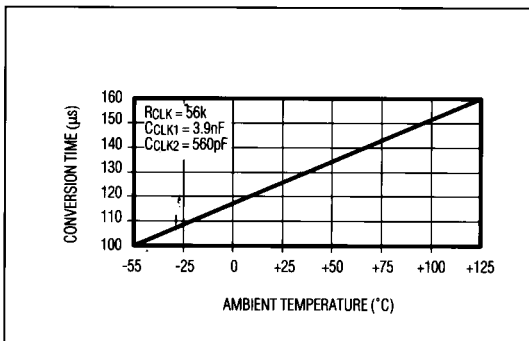

Figure 10. Typical Conversion Time vs. Temperature Using Internal Clock

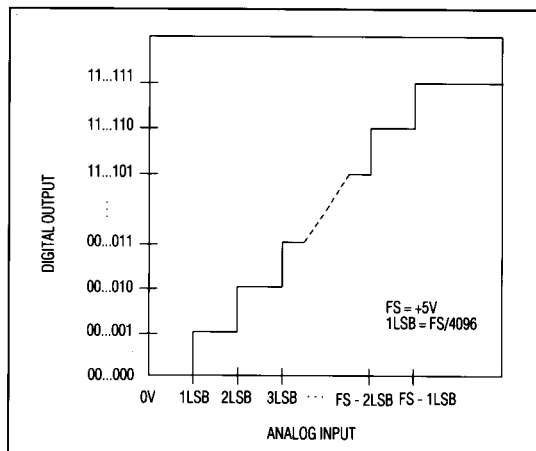

Figure 12. Ideal Input/Output Transfer Characteristic for Unipolar Circuit of Figure 11

Calibrated 12-Bit A/D Converter

MX7578

Figure 14 shows how bipolar signals (-5V to +5V) are accommodated by referencing a resistor divider network to REFIN. The signal source must be capable of sinking 0.5mA with the resistor values shown. Refer to Figure 15 and Table 2 for the input/output transfer characteristic and transition points for the $\pm 5V$ signal range, respectively. The output code is offset binary with an LSB size of: $(FS)(1/4096) = (10/4096)V = 2.44mV$.

To adjust bipolar zero error, apply $1.22mV$ ($+1/2LSB$) to AIN and adjust the offset of A1 so that the ADC output switches between 1000 0000 0000 and 1000 0000 0001.

Power-Supply Decoupling

Power supplies to the MX7578 should be bypassed with a $10\mu F$ electrolytic or tantalum capacitor in parallel with a $0.01\mu F$ disc ceramic capacitor for clean, high-frequency performance. Place all capacitors as close as possible to the MX7578.

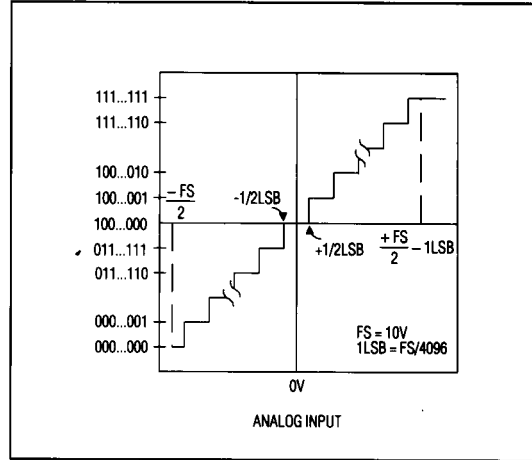

Figure 15. Ideal Input/Output Transfer Characteristic for Bipolar Circuit of Figure 14

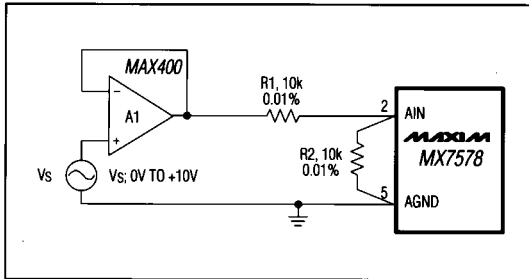

Figure 13. Unipolar 0V to +10V Operation

Table 1. Transition Points for Unipolar 0V to +5V Operation

| Analog Input (V) | Digital Output |
|------------------|----------------|
| 0.00122 | 0000 0000 0001 |
| 0.00244 | 0000 0000 0010 |
| ... | ... |
| 2.49878 | 0111 1111 1111 |
| 2.50000 | 1000 0000 0000 |
| 2.50122 | 1000 0000 0001 |
| ... | ... |
| 4.99756 | 1111 1111 1110 |
| 4.99878 | 1111 1111 1111 |

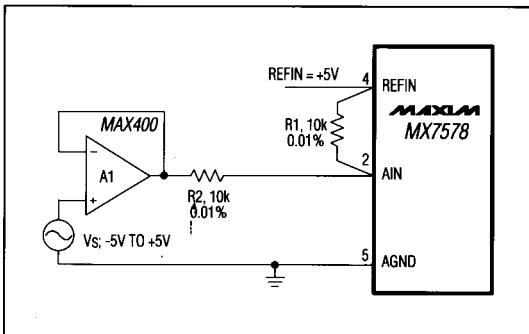

Figure 14. Bipolar -5V to +5V Operation

Table 2. Transition Points for Bipolar -5V to +5V Operation

| Analog Input (V) | Digital Output |
|------------------|----------------|
| -4.99878 | 0000 0000 0001 |
| -4.99634 | 0000 0000 0010 |
| ... | ... |
| -0.00122 | 1000 0000 0000 |
| +0.00122 | 1000 0000 0001 |
| ... | ... |
| +4.99389 | 1111 1111 1110 |
| +4.99634 | 1111 1111 1111 |

Calibrated 12-Bit A/D Converter

Reference Circuit

Figure 16 shows how to set up a Maxim MX584LH to generate a reference voltage of +5.00V. An adjustment range of $\pm 75\text{mV}$ is provided by R2. Over the commercial temperature range, the MX584LH will contribute no more than $\pm 1\text{LSB}$ of gain error.

During a conversion, transient currents flow at the REFIN input. To prevent dynamic errors, place either a $10\mu\text{F}$ electrolytic or tantalum smoothing capacitor in parallel with a $0.01\mu\text{F}$ disc ceramic from the REFIN pin to AGND.

Layout

When designing a layout for a printed circuit board, keep digital and analog signal lines separated whenever possible. It is critical that no digital line run alongside an analog signal line or near the CAZ. Guard the analog inputs, the reference input and the auto-zero input with traces connected to AGND.

Establish a single-point analog ground (AGND) as close to the MX7578 as possible, isolated from the logic system. Connect the single-point analog ground to the digital system ground, which is attached to DGND at one point and as close as possible to the MX7578. The following should be returned to the analog ground point:

input-signal common, input guards, CAZ, and any bypass capacitors for the reference input and the analog supplies. Low-impedance analog and digital power-supply common returns with wide trace widths are essential for quiet operation of the MX7578.

Noise

To minimize the input noise coupling, input signal leads to AIN and signal return leads from AGND should be kept as short as possible. A shielded cable between source and ADC is suggested in applications where longer leads are required. Also, care should be taken to reduce the ground-circuit impedances as much as possible since any potential difference in grounds between the signal source and ADC creates an error voltage in series with the input signal.

When interfacing to continuously busy and noisy microprocessor buses, it is possible to get errors at the LSB level. These errors exist because of feed-through from the bus to the integrated circuit through the package. The problem can be minimized in ceramic side braze (Ceramic SB) packaged chips by grounding the metal lid. Another solution is to isolate the MX7578 from the microprocessor bus with three-state buffers.

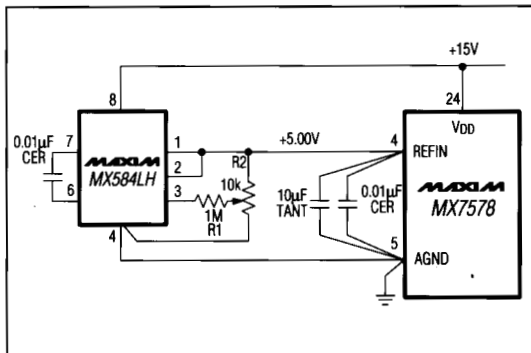
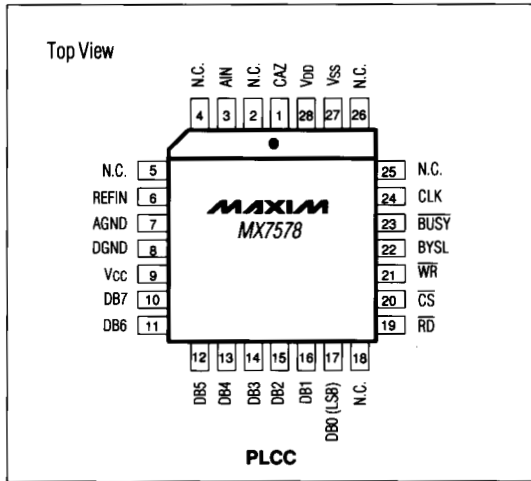

Figure 16. MX584LH as Reference Generator

Calibrated 12-Bit A/D Converter

Pin Configurations (continued)



Chip Topography

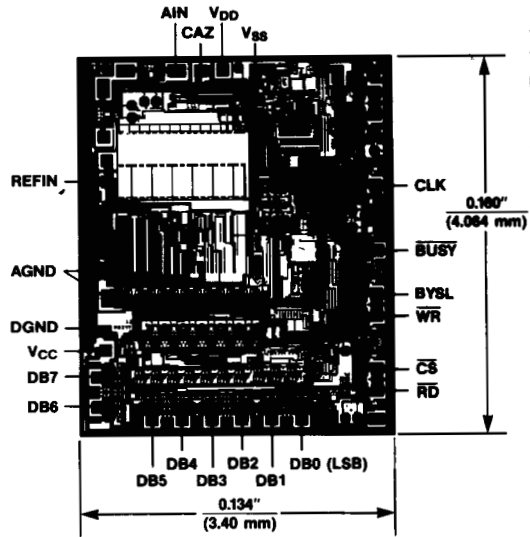

MAX7578

Calibrated 12-Bit A/D Converter

MX7578

Package Information

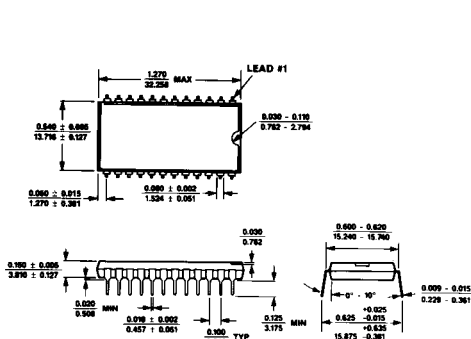

24 Lead Plastic DIP (PG)

$\theta_{JA} = 110^{\circ}\text{C/W}$

$\theta_{JC} = 50^{\circ}\text{C/W}$

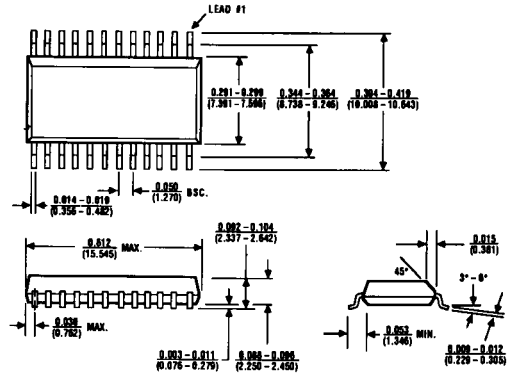

24 Lead Small Outline, Wide (WG)

$\theta_{JA} = 85^{\circ}\text{C/W}$

$\theta_{JC} = 45^{\circ}\text{C/W}$

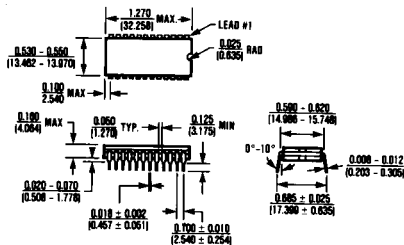

24 Lead CERDIP (JG)

$\theta_{JA} = 55^{\circ}\text{C/W}$

$\theta_{JC} = 20^{\circ}\text{C/W}$

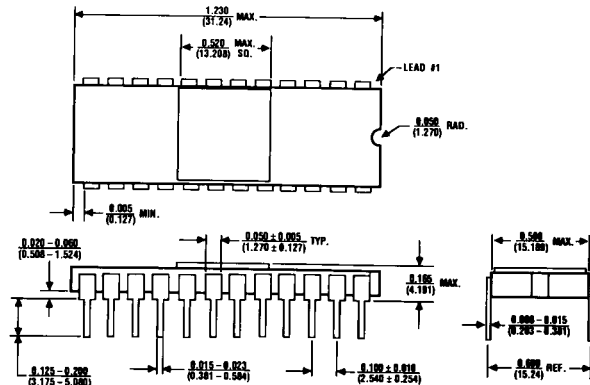

24 Lead Ceramic Sidebrazed (DG)

$\theta_{JA} = 50^{\circ}\text{C/W}$

$\theta_{JC} = 15^{\circ}\text{C/W}$

Maxim cannot assume responsibility for use of any circuitry other than circuitry entirely embodied in a Maxim product. No circuit patent licenses are implied. Maxim reserves the right to change the circuitry and specifications without notice at any time.

12 _____ **Maxim Integrated Products, 120 San Gabriel Drive, Sunnyvale, CA 94086 (408) 737-7600**