



Micro Commercial Components
 21201 Itasca Street Chatsworth
 CA 91311
 Phone: (818) 701-4933
 Fax: (818) 701-4939

MURHB805CT THRU MURHB860CT

Features

- High Current Capability
- Low Reverse Leakage
- Low Forward Voltage Drop
- High Current Capability
- Super Fast Switching Speed For High Efficiency

**8 Amp
 Super Fast
 Recovery Rectifier
 50 to 600 Volts**

Maximum Ratings

- Operating Temperature: -55°C to +150°C
- Storage Temperature: -55°C to +150°C

MCC Catalog Number	Maximum Recurrent Peak Reverse Voltage	Maximum RMS Voltage	Maximum DC Blocking Voltage
MURHB805CT	50V	35V	50V
MURHB810CT	100V	70V	100V
MURHB820CT	200V	140V	200V
MURHB840CT	400V	280V	400V
MURHB860CT	600V	420V	600V

D²PAK

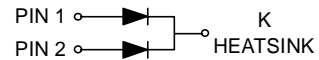
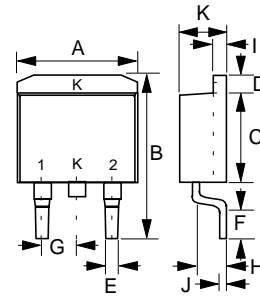

Electrical Characteristics @ 25°C Unless Otherwise Specified

Average Forward Current	$I_{F(AV)}$	8 A	$T_C = 125^\circ\text{C}$
Peak Forward Surge Current	I_{FSM}	55A	8.3ms, half sine
Maximum Instantaneous Forward Voltage 805CT- 820CT 840CT 860CT	V_F	1.25 V 1.5 V 1.75 V	$I_{FM} = 10A;$ $T_A = 25^\circ\text{C}$
Maximum DC Reverse Current At Rated DC Blocking Voltage	I_R	50µA 50µA	$T_A = 25^\circ\text{C}$ $T_A = 100^\circ\text{C}$
Maximum Reverse Recovery Time 805CT- 820CT 840CT 860CT	T_{rr}	35ns 50ns 75ns	$I_F=0.5A, I_R=1.0A,$ $I_{rr}=0.25A$

DIM	INCHES		MM		NOTE
	MIN	MAX	MIN	MAX	
A	.380	.421	9.65	10.69	
B	.575	.625	14.60	15.88	
C	.325	.364	8.25	9.25	
D	.045	.055	1.14	1.40	
E	.020	.045	0.51	1.14	
F	.090	.110	2.29	2.79	
G	.090	.110	2.29	2.79	
H	.080	.115	2.03	2.92	
I	.045	.055	1.14	1.40	
J	.012	.025	0.30	0.64	
K	.172	.190	4.37	4.83	

*Pulse Test: Pulse Width 300µsec, Duty Cycle 2%

Figure 1
Typical Forward Characteristics

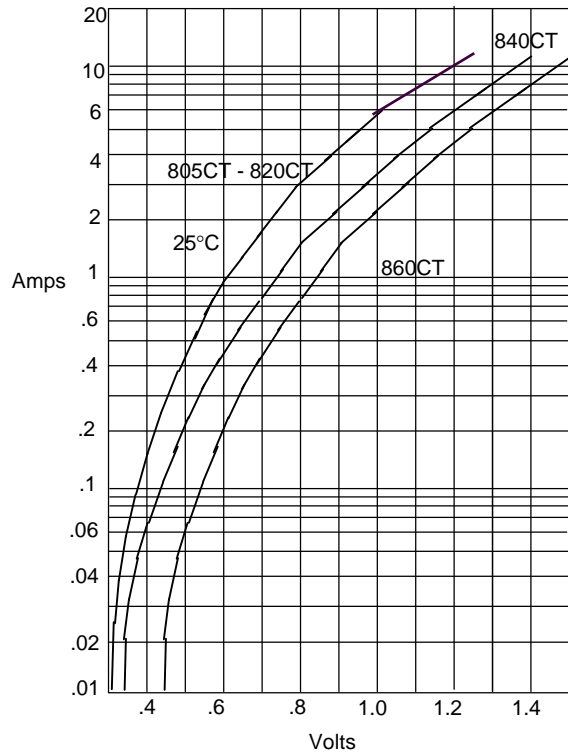

Instantaneous Forward Current - Amperes versus
Instantaneous Forward Voltage - Volts

Figure 2
Forward Derating Curve

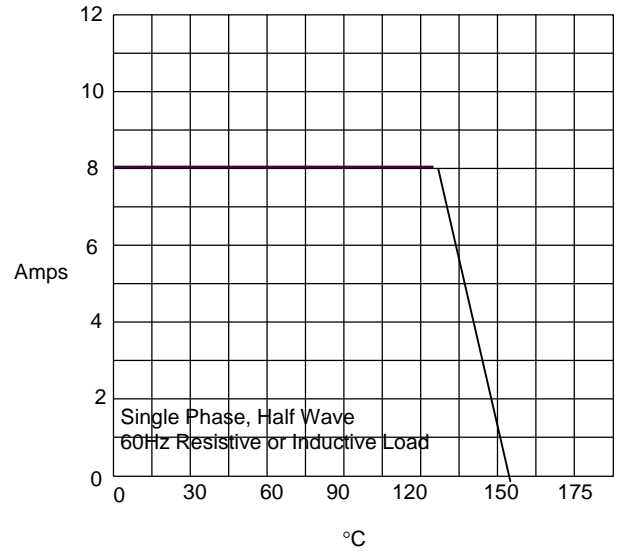

Average Forward Rectified Current - Amperes versus
Ambient Temperature - °C

Figure 3
Junction Capacitance

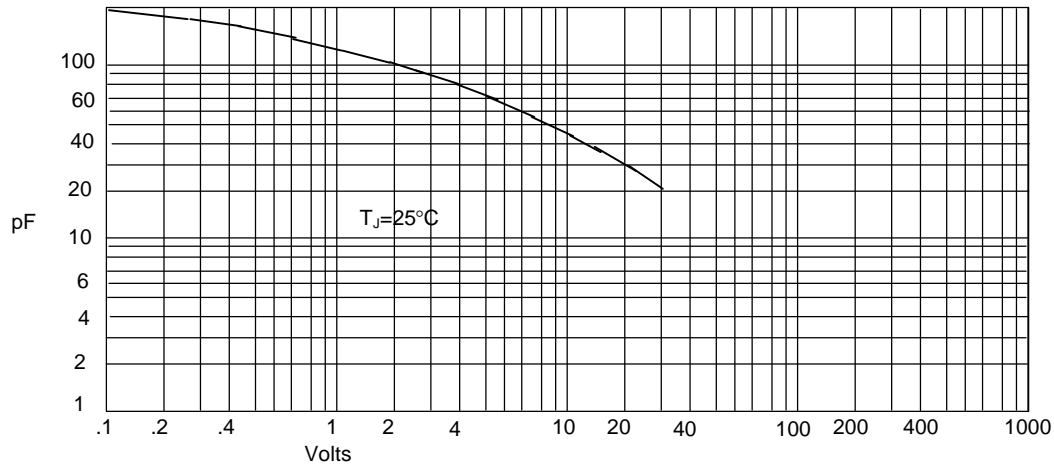

Junction Capacitance - pF versus
Reverse Voltage - Volts

MURHB805CT thru MURHB860CT

Figure 4
Typical Reverse Characteristics

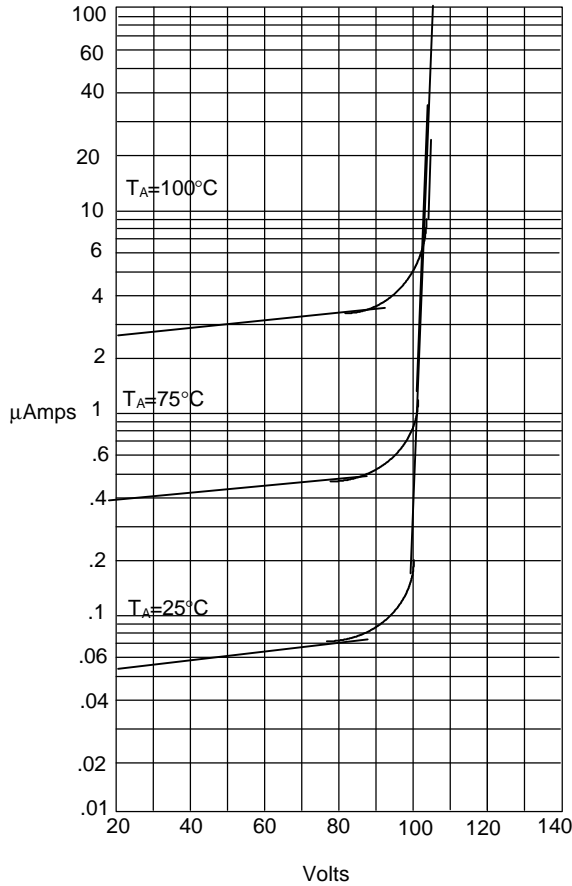

Instantaneous Reverse Leakage Current - MicroAmperes versus
Percent Of Rated Peak Reverse Voltage - Volts

Figure 5
Peak Forward Surge Current

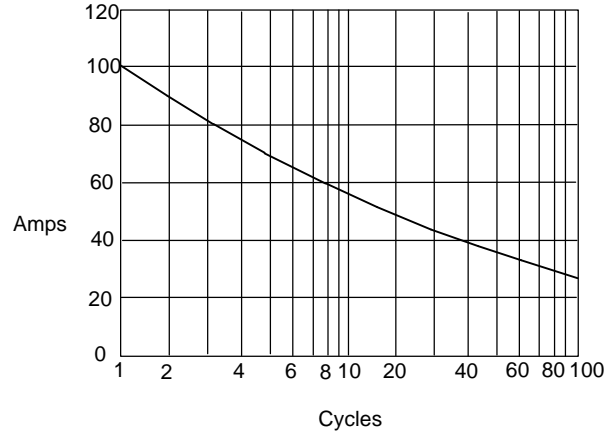

Peak Forward Surge Current - Amperes versus
Number Of Cycles At 60Hz - Cycles

Figure 6
Reverse Recovery Time Characteristic And Test Circuit Diagram

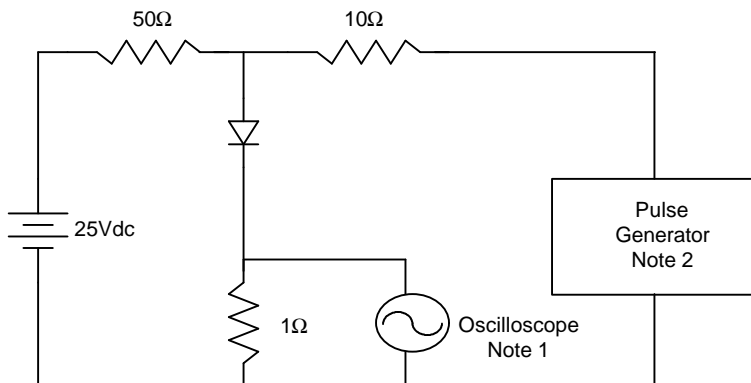

- Notes:
1. Rise Time = 7ns max.
Input impedance = 1 megohm, 22pF
 2. Rise Time = 10ns max.
Source impedance = 50 ohms
 3. Resistors are non-inductive

