

---

---

# MCP2120/MCP2150 DEVELOPER'S KIT USER'S GUIDE

Information contained in this publication regarding device applications and the like is intended by way of suggestion only. No representation or warranty is given and no liability is assumed by Microchip Technology Incorporated with respect to the accuracy or use of such information. Use of Microchip's products as critical components in life support systems is not authorized except with express written approval by Microchip.

© 2001 Microchip Technology Incorporated. All rights reserved.

The Microchip logo, name, PIC, PICmicro, PICSTART, PRO MATE, KEELOQ, MPLAB, and MXDEV are registered trademarks of Microchip Technology Incorporated in the U.S.A. and other countries. microID, and *Smart Serial* are trademarks of Microchip Technology in the U.S.A. and other countries.

All product/company trademarks mentioned herein are the property of their respective companies.

# MCP2120/2150 User's Guide

---

---

NOTES:

---

---

**Table of Contents**

---

---

**Chapter 1. Introduction**

1.1	Welcome .....	1
1.2	MCP2120/MCP2150 Developer's Kit User's Guide .....	2
1.3	Sample Devices .....	3
1.4	Reference Documents .....	3
1.5	Other Related Documents .....	3

**Chapter 2. Getting Started**

2.1	Introduction .....	5
2.2	Highlights .....	5
2.3	Developer Board Features .....	6
2.4	System Configurations .....	17
2.5	PC Requirements .....	20

**Chapter 3. MCP2120 Tutorial**

3.1	Introduction .....	21
3.2	Highlights .....	21
3.3	MCP2120 Tutorial Setup .....	21
3.4	Hardware Setup .....	22
3.5	Setting Up the Terminal Program .....	25
3.6	Transmitting/Receiving Data .....	35

**Chapter 4. MCP2150 Tutorial**

4.1	Introduction .....	39
4.2	Highlights .....	39
4.3	MCP2150 Tutorial .....	39

**Chapter 5. Using a PICDEM™ 1 or PICDEM™ 2 Board as Host**

5.1	Using the PICDEM 1 Board .....	41
5.2	Using the PICDEM 2 Board .....	43

# MCP2120/MCP2150 USER'S GUIDE

---

---

## Appendix A. Hardware Detail

A.1	Power Supply .....	45
A.2	Power Indicator .....	45
A.3	RS-232 Serial Port .....	45
A.4	Jumpers .....	46
A.5	Oscillator Options .....	48
A.6	Board Layout .....	49
A.7	Schematics .....	50
	Revision History .....	53
	Index .....	55
	Worldwide Sales and Service .....	0

---

---

## Chapter 1. Introduction

---

---

### 1.1 Welcome

Thank you for purchasing the MCP2120/MCP2150 Developer's Kit from Microchip Technology Inc. The MCP2120/MCP2150 Developer's Kit demonstrates the capabilities of the MCP2120 and MCP2150 infrared communication products.

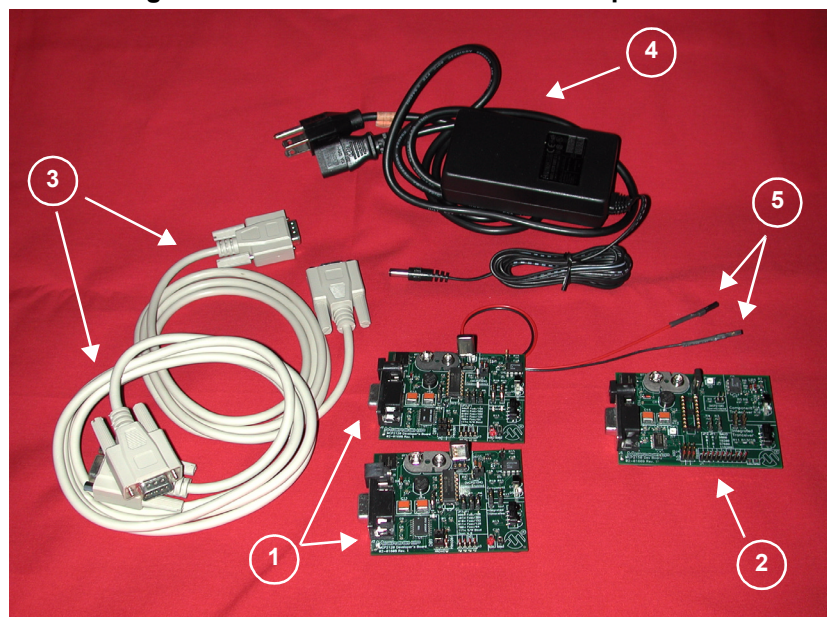
The MCP2120 Developer's Board and the MCP2150 Developer's Board can be connected to either a PC via the DB9 connector, or to another system (such as a PICDEM 2 board) via the four pin header.

The MCP2120/MCP2150 Developer's Kit comes with the following:

1. Two MCP2120 Developer Boards.
2. One MCP2150 Developer Board.
3. Two serial cables.
4. One 9V power supply, with power cord.
5. One pair 18" (45 cm) power jumper cables.
6. Sample kit (one MCP2120 device and one MCP2150 device)—Not shown.
7. MCP2120/MCP2150 Developer's Kit User's Guide (This document)—Not shown.

If you are missing any part of the kit, please contact your nearest Microchip sales office listed in the back of this publication for help.

**Figure 1.1: MCP2120/MCP2150 Developer's Kit**



# MCP2120/MCP2150 USER'S GUIDE

---

## 1.2 MCP2120/MCP2150 Developer's Kit User's Guide

This document describes the MCP2120/MCP2150 Developer's Kit and tutorials, giving the user a brief overview of Microchip's MCP2120 and MCP2150 family of infrared communication products. Detailed information on the individual device may be found in the device's respective data sheet. Detailed information on the PICDEM 2 development board may be found in the PICDEM 2 User's Guide (DS30374).

**Chapter 1:** Introduction – This chapter introduces the MCP2120/MCP2150 Developer's Kit, lists the components in the kit, and lists related documentation.

**Chapter 2:** Getting Started – This chapter gives an overview of the MCP2120 and MCP2150 Developer's Boards, the hardware features of each Developer's Board, the system configurations that can be used to demonstrate the MCP2120 and MCP2150 devices, and the PC requirements.

**Chapter 3:** MCP2120 Tutorial – This chapter provides a detailed description of the steps to get the MCP2120 Developer's board operating. These steps include the configuration of the Developer's boards and the Terminal Emulation program (Hyperterminal) used on the PC.

**Chapter 4:** MCP2150 Tutorial – This chapter provides a detailed description of the steps to get the MCP2150 Developer's board operating. These steps include the configuration of the Developer's boards, the Terminal Emulation program (Hyperterminal) used on the PC, and the installation and configuration of the PC IrDA standard drivers.

**Chapter 5:** Using PICDEM 1 or PICDEM 2 Board as Host. This chapter discusses the use of the PICDEM boards as a demonstration platform as a Host Controller for an MCP2120 Developer's Board or an MCP2150 Developer's Board. This chapter makes reference to Application Notes which contain demonstration code.

**Appendix A:** Hardware Description: This appendix describes in detail the hardware of the MCP2120 Developer's board and MCP2150 Developer's board. This includes the component layout of each board (silkscreen) and the schematic of each board.

**Revision History:** This covers the major changes to the document between the revisions.

**Index:** This lists the pages where major topics are located.

## 1.3 Sample Devices

Each kit comes with one MCP2120 device and one MCP2150 device. This allows a prototype system to be developed that can be used with an MCP2120 Developer's Board or an MCP2150 Developer's Board.

## 1.4 Reference Documents

Reference documents may be obtained by contacting your nearest Microchip sales office (listed in the back of this document) or by downloading via the Microchip website ([www.microchip.com](http://www.microchip.com)).

- MCP2120 Data Sheet, DS21618
- MCP2150 Data Sheet, DS21655
- AN756, "Using the MCP2120 for Infrared Communication", DS00756
- AN758, "Using the MCP2150 to Add IrDA® Standard Wireless Connectivity", DS00758
- TB046, "Connecting the MCP2150 to the Psion Operating System", DS91046
- TB047, "Connecting the MCP2150 to the Windows® CE Operating System", DS91047
- TB048, "Connecting the MCP2150 to the Windows® Operating System", DS91048
- TB049, "Connecting the MCP2150 to the Palm™ Operating System", DS91049

## 1.5 Other Related Documents

- MPASM User's Guide with MPLINK™ Linker and MPLIB™ Library, DS33014
- PRO MATE® II User's Guide, DS30082
- PICSTART® Plus User's Guide, DS51028
- MPLAB® ICE User's Guide, DS51159
- MPLAB® ICD User's Guide, DS51184
- Microchip's Third Party Guide, DS00104

IrDA is a registered trademark of the Infrared Data Association.

# MCP2120/MCP2150 USER'S GUIDE

---

---

NOTES:



---

---

## **Chapter 2. Getting Started**

---

---

### **2.1 Introduction**

This chapter covers an overview of the MCP2120 and MCP2150 Developer's Boards features, the system configurations that they can be used in, and the system requirements for the tutorials.

### **2.2 Highlights**

Topics covered in this chapter

- MCP2120 Developer's Board
- MCP2150 Developer's Board
- System Configurations
- PC Requirements

# MCP2120/MCP2150 USER'S GUIDE

---

## 2.3 Developer Board Features

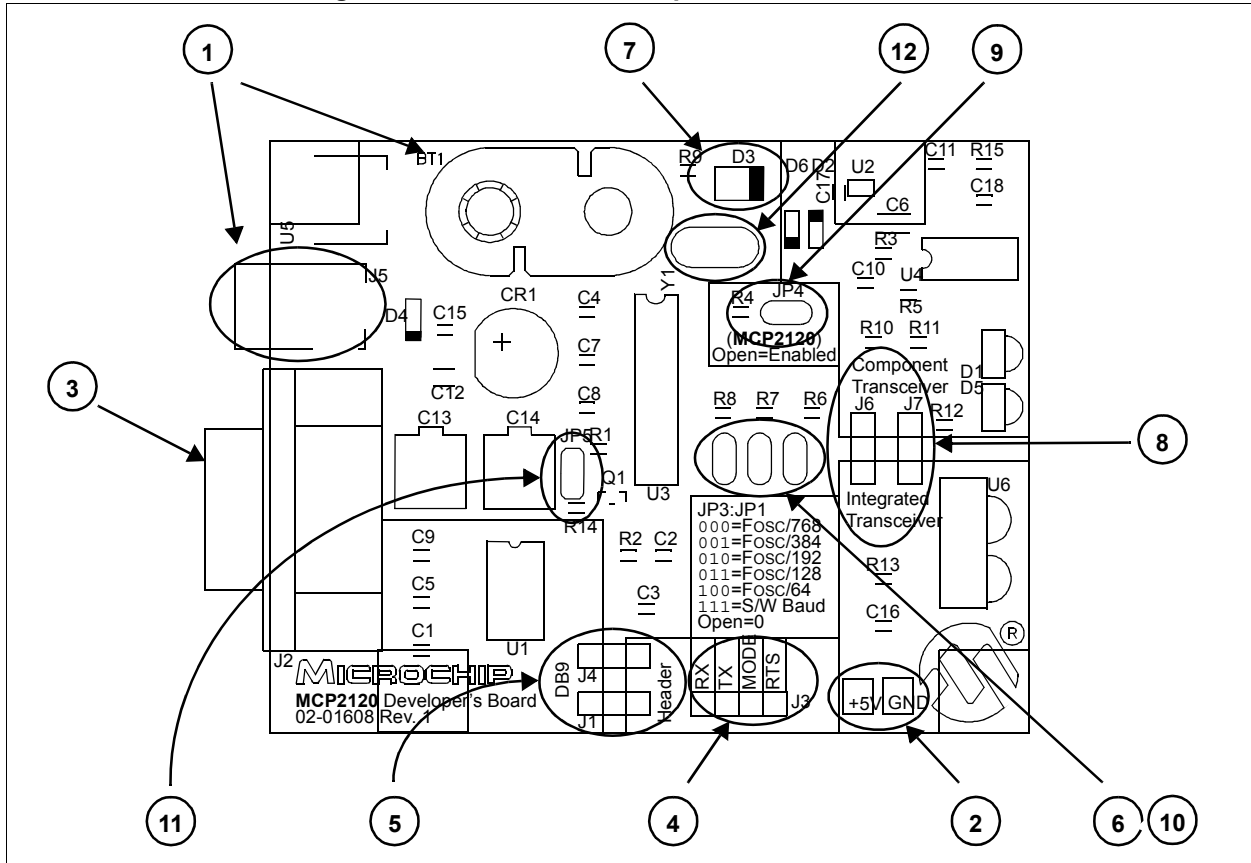
### 2.3.1. MCP2120 Developer's Board

The MCP2120 Developer's Board, as shown in Figure 2.1, has the following hardware features:

1. On-board +5V regulator for direct input from 9V, 750 mA AC/DC wall adapter or 9V battery.
2. Hooks for a +5V, 750 mA regulated DC supply.
3. DB-9 connector and associated hardware for direct connection to MCP2120 UART (DB-9 interface requires RS-232 signal levels).
4. Four-pin header connection to UART interface (Header requires TTL level signals).
5. Two jumpers to select source of UART signals. Either DB-9 connector or the four-pin header.
6. Three jumpers to select desired baud rate.
7. Green power-on indicator LED.
8. Two IR Transceiver options (two jumpers select transceiver).
9. Jumper to disable MCP2120 device operation.
10. Hardware and Software Baud selection.
11. Jumper for Software Baud control when using RS-232C interface.
12. Socketed crystal.

**Note:** A schematic of the MCP2120 Developer's Board is shown in Figure A.5

Figure 2.1: MCP2120 Developer's Board Hardware



# MCP2120/MCP2150 USER'S GUIDE

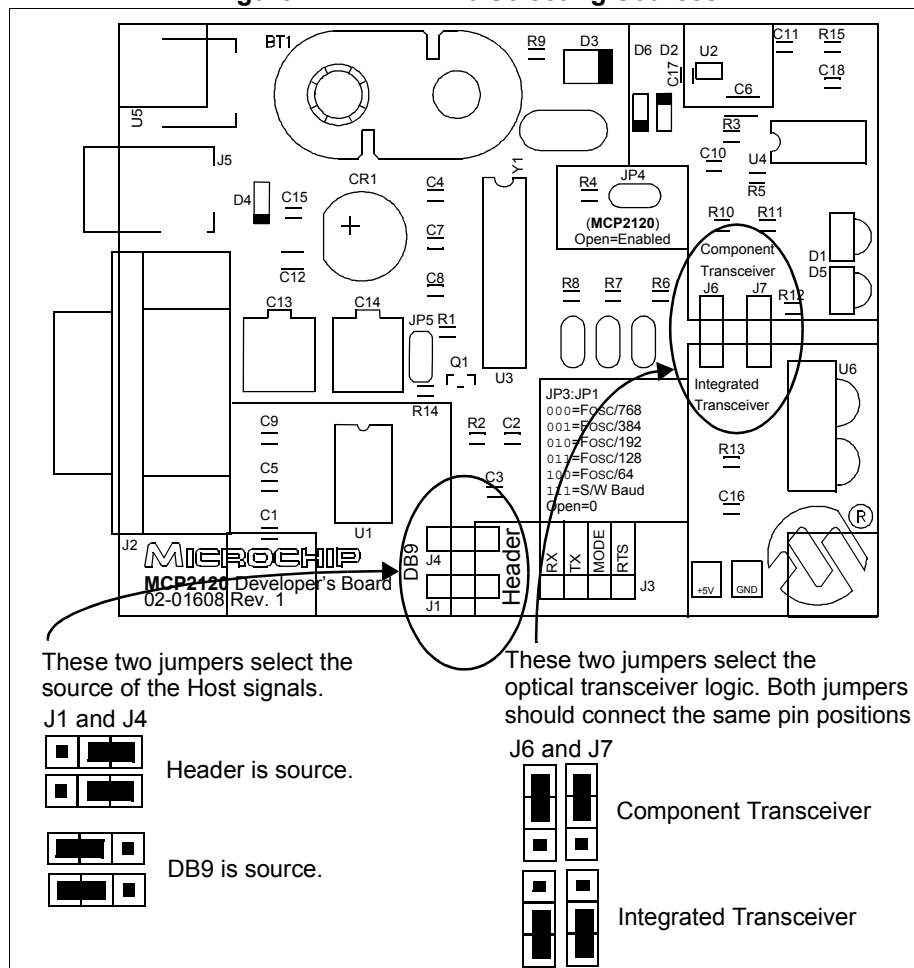
## 2.3.1.1 Selecting UART Source and Optical Transceiver Interface

Figure 2.2 shows two pairs of jumpers used to route signals to and from the MCP2120.

Jumpers J1 and J4 are used to determine the source of the signals used by the UART interface. When the header has the pins closest to the “DB9” label jumpered to the center pin, the DB9 is the source of the UART signal. When the header has the pins closest to the “Header” label jumpered to the center pin, the four-pin header is the source of the UART signal.

Jumpers J6 and J7 are used to determine the source and destination of the infrared data signals used by the interface between the MCP2120 and Optical Transceiver. When the header has the pins closest to the “Integrated Transceiver” label jumpered to the center pin, the integrated transceiver is used. When the header has the pins closest to the “Component Transceiver” label jumpered to the center pin, the component transceiver logic is used.

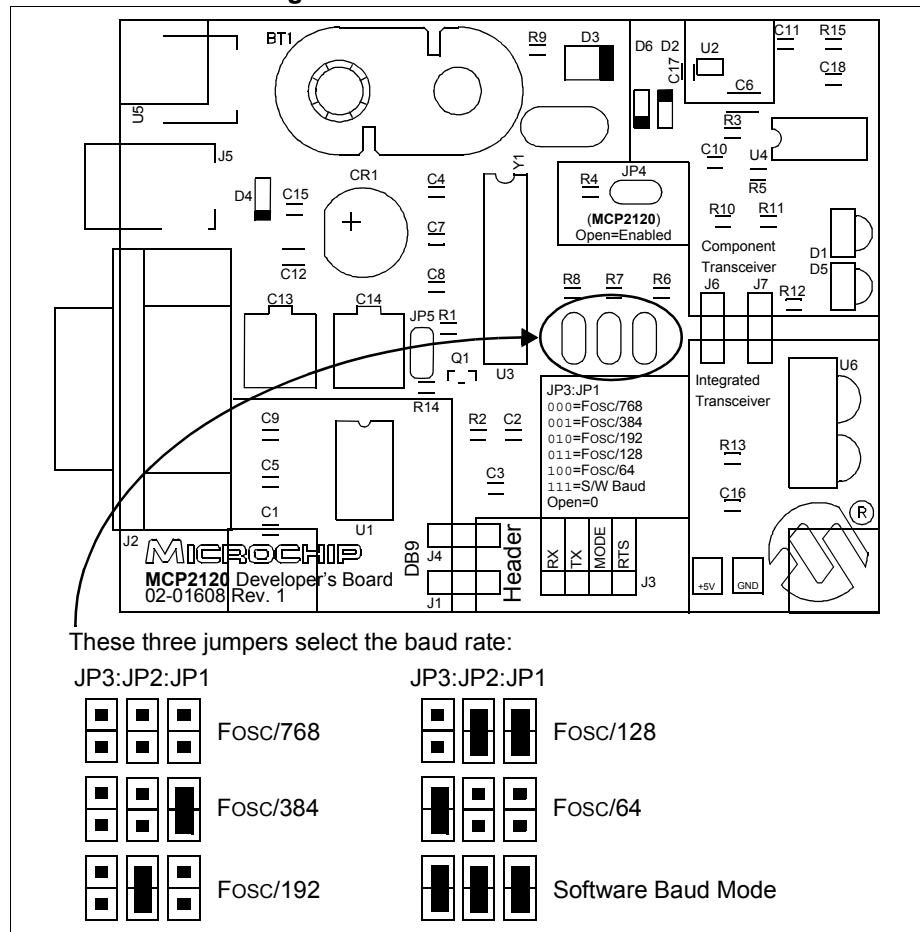
**Figure 2.2: MCP2120 Selecting Sources**



## 2.3.1.2 Selecting Baud Rate

Figure 2.3 shows the three Baud Rate Select Jumpers (JP3:JP1) and the baud rate formula that is specified (baud rate dependant on MCP2120 operational frequency). Table 2.1 shows the baud rates for some crystal frequencies.

**Figure 2.3: MCP2120 Baud Rate**



**Table 2.1 Hardware Baud Rate Selection vs. Frequency**

BAUD2:BAUD0	Fosc Frequency (MHz)							Bit Rate
	0.6144 <sup>(1)</sup>	2.000	3.6864	4.9152	7.3728	14.7456 <sup>(2)</sup>	20.000 <sup>(2)</sup>	
000	800	2604	4800	6400	9600	19200	26042	Fosc / 768
001	1600	5208	9600	12800	19200	38400	52083	Fosc / 384
010	3200	10417	19200	25600	38400	78600	104167	Fosc / 192
011	4800	15625	28800	38400	57600	115200	156250	Fosc / 128
100	9600	31250	57600	78600	115200	230400	312500	Fosc / 64

**Note 1:** An external clock is recommended for frequencies below 2 MHz.

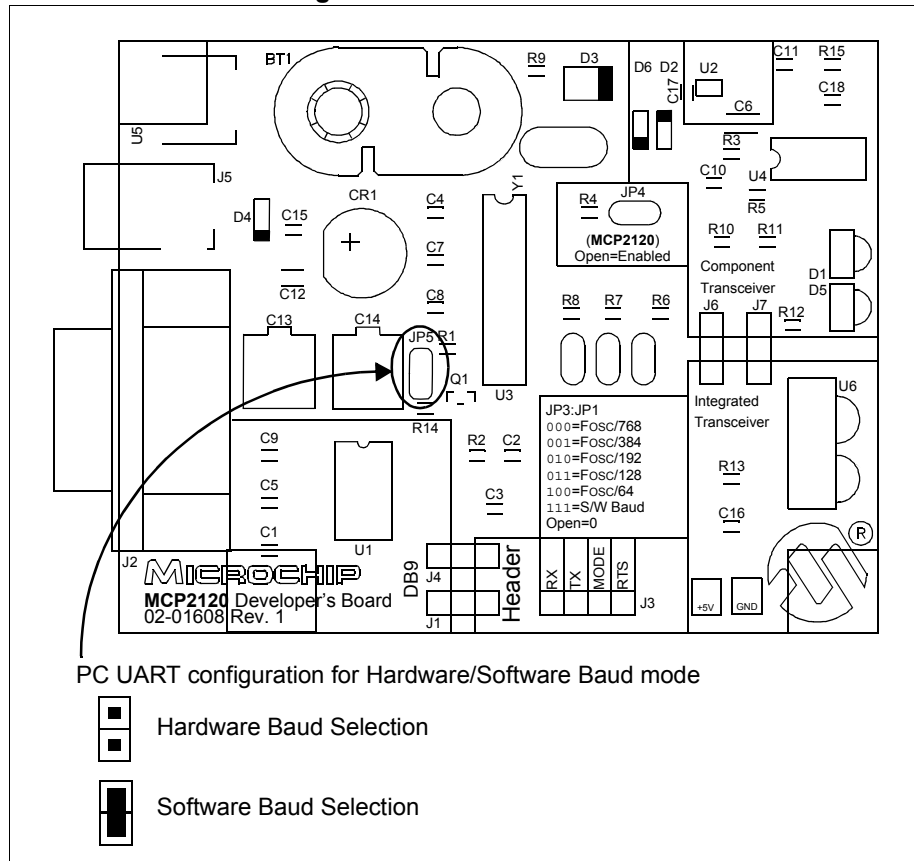
**Note 2:** For frequencies above 7.5 MHz, the TXIR pulse width (MCP2120 Data Sheet, Electrical Specification, parameter IR121) will be shorter than the minimum pulse width of 1.6 μs in the IrDA standard specification.

# MCP2120/MCP2150 USER'S GUIDE

## 2.3.1.3 UART Mode

Figure 2.4 shows the jumper which determines if the MCP2120 Developer's Board is to be used in Hardware Baud operation, or Software Baud operation. When in Software Baud operation, an additional signal is required, Request To Send (RTS), which is used to drive the RESET pin low to cause a change of baud rate to occur.

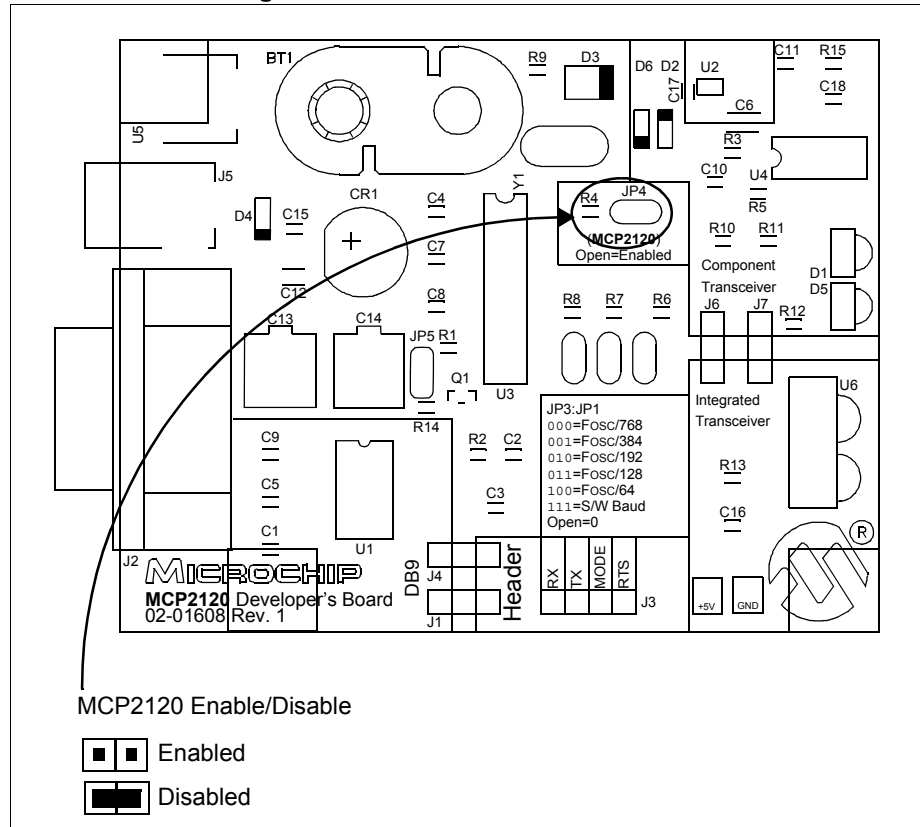
Figure 2.4: MCP2120 UART



## 2.3.1.4 Disabling the MCP2120

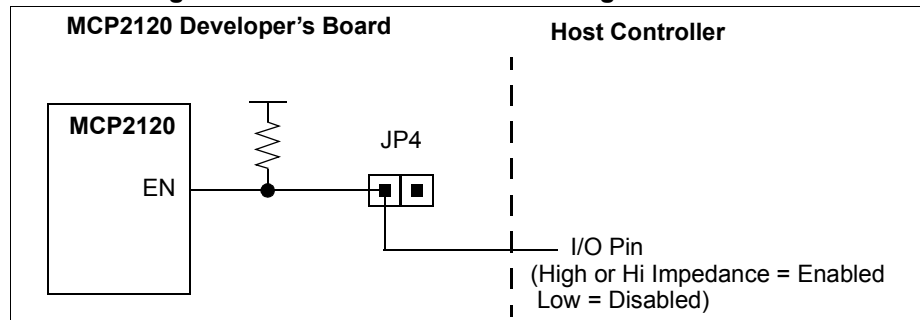
Figure 2.5 shows the jumper, JP4, which will enable or disable the MCP2120 device. When the MCP2120 is disabled, the device will consume less current.

**Figure 2.5: MCP2120 Enable/Disable**



In most cases, this jumper will be open. It may be closed to test system operation when the MCP2120 is disabled. The Host Controller board may control the operation of the MCP2120 by connecting a signal to the JP4 header as shown in Figure 2.6.

**Figure 2.6: Host Controller Disabling the MCP2120**



# MCP2120/MCP2150 USER'S GUIDE

---

## 2.3.2. MCP2150 Developer's Board

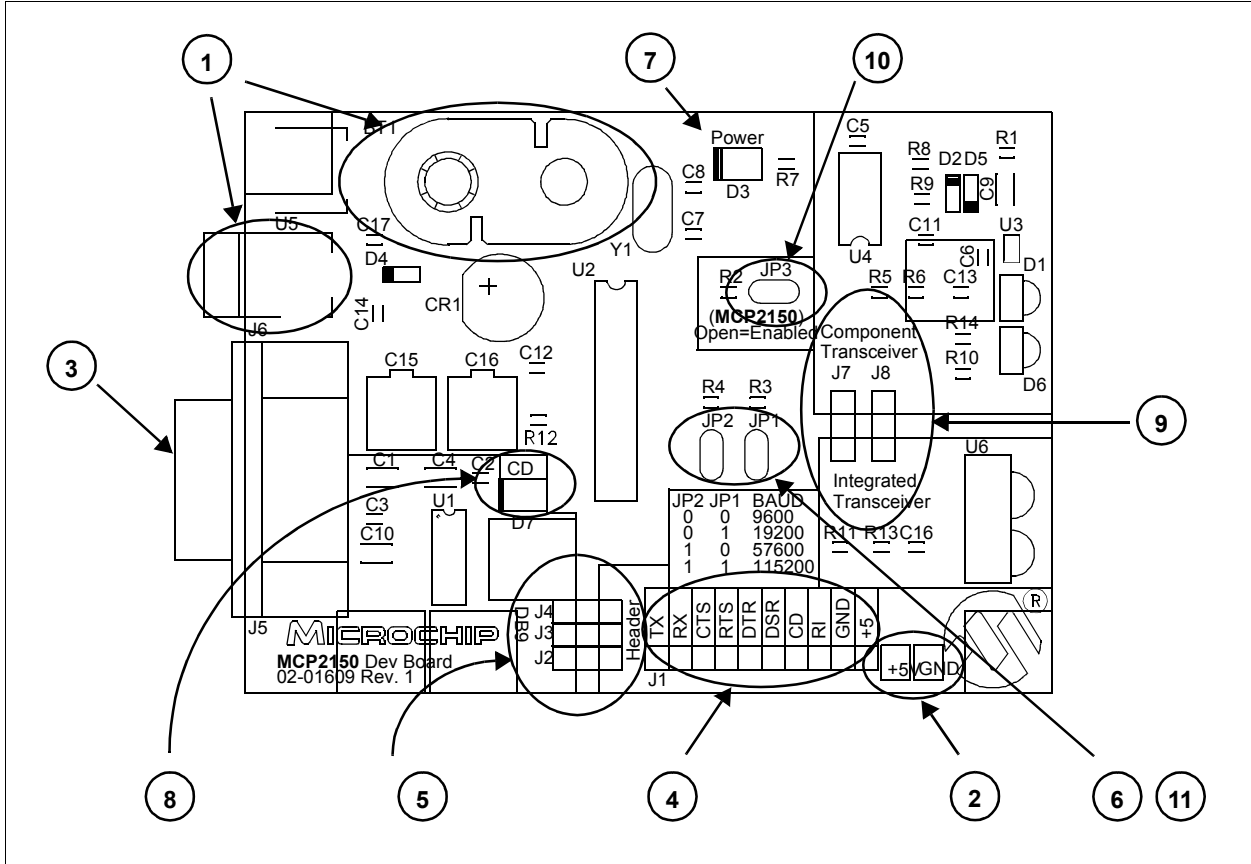
The MCP2150 Developer's Board, as shown in Figure 2.7, has the following hardware features:

1. On-board +5V regulator for direct input from 9V, 750 mA AC/DC wall adapter or 9V battery.
2. Hooks for a +5V, 750 mA regulated DC supply.
3. DB-9 connector and associated hardware for direct connection to MCP2150 UART (DB-9 interface requires RS-232 signal levels).
4. Ten-pin header connection to UART interface (Header requires TTL level signals).
5. Three jumpers to select source of UART signals. Either DB-9 connector or the eight-pin header.
6. Two jumpers to select desired baud rate.
7. Green power-on indicator LED.
8. Green LED for Carrier Detect.
9. Two IR Transceiver options (two jumpers select transceiver).
10. Jumper to disable MCP2150 device operation.
11. Hardware Baud selection.

**Note:** A schematic of the MCP2150 Developer's Board is shown in Figure A.6



Figure 2.7: MCP2150 Board Hardware



# MCP2120/MCP2150 USER'S GUIDE

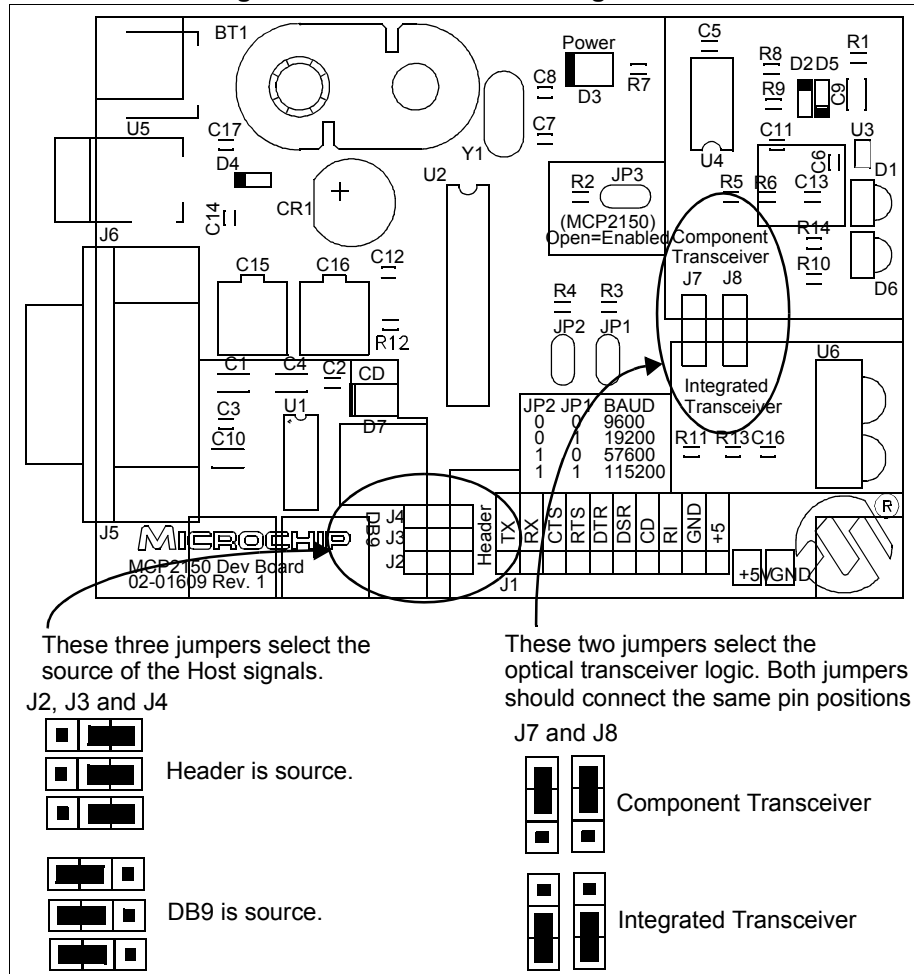
## 2.3.2.1 Selecting UART Source and Optical Transceiver Interface

Figure 2.8 shows two sets of jumpers used to route signals to and from the MCP2150.

Jumpers J2, J3 and J4 are used to determine the source of the signals used by the UART interface. When the header has the pins closest to the “DB9” label jumpered to the center pin, the DB9 is the source of the UART signal. When the header has the pins closest to the “Header” label jumpered to the center pin, the four-pin header is the source of the UART signal.

Jumpers J7 and J8 are used to determine the source and destination of the IrDA signals used by the interface between the MCP2150 and Optical Transceiver. When the header has the pins closest to the “Integrated Transceiver” label jumpered to the center pin, the integrated transceiver is used. When the header has the pins closest to the “Component Transceiver” label jumpered to the center pin, the component transceiver logic is used.

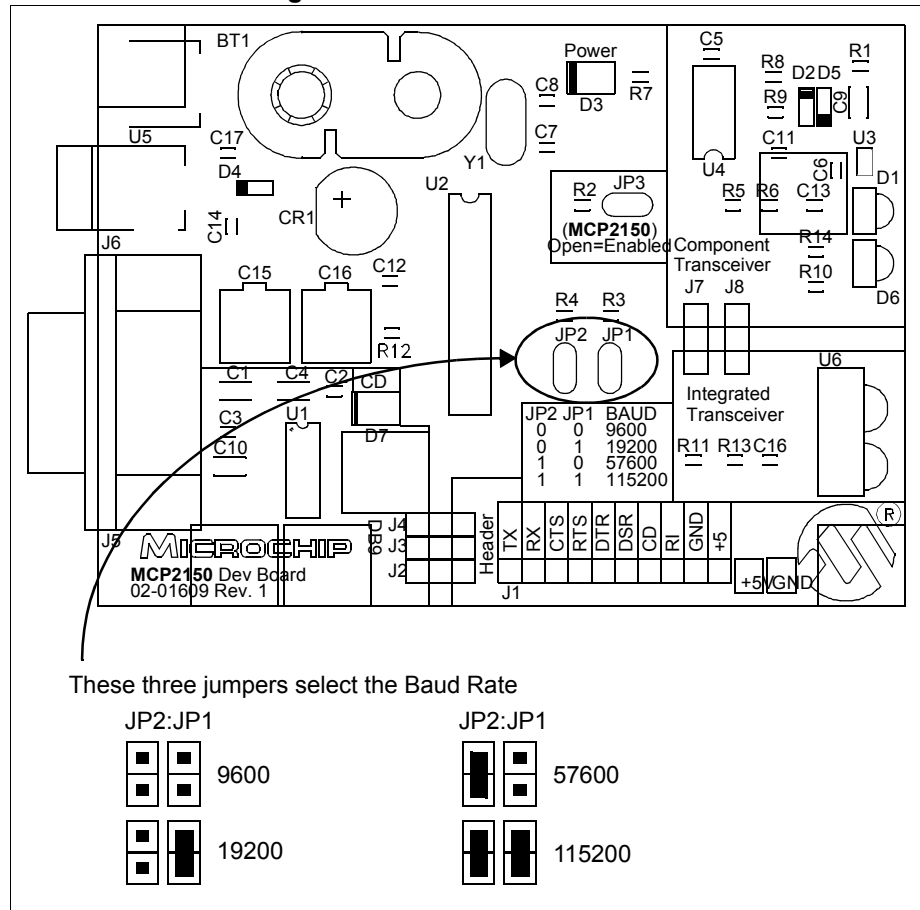
**Figure 2.8: MCP2150 Selecting Sources**



## 2.3.2.2 Selecting Baud Rate

Figure 2.9 shows the two Baud Rate Select jumpers (JP2:JP1) and the baud rate. Table 2.2 shows the baud rates for some crystal frequencies.

**Figure 2.9: MCP2150 Baud Rate**



**Table: 2.2 Serial Baud Rate Selection vs. Frequency**

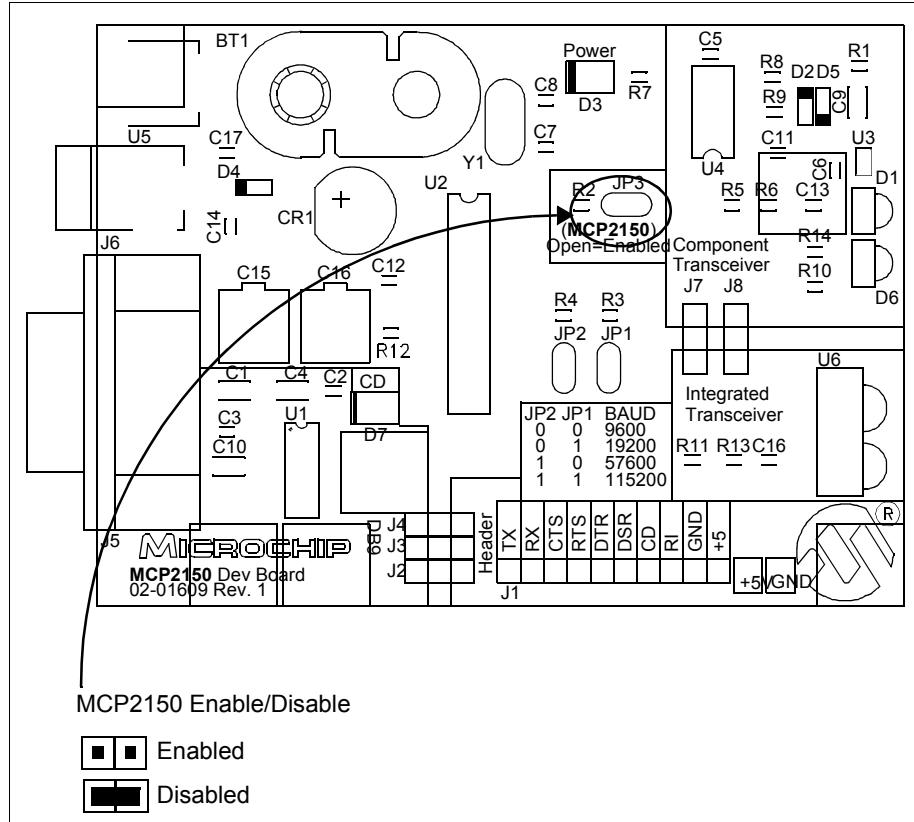
BAUD1:BAUD0	Baud Rate @ 11.0592 MHz	Bit Rate
00	9600	Fosc / 1152
01	19200	Fosc / 576
10	57600	Fosc / 192
11	115200	Fosc / 96

# MCP2120/MCP2150 USER'S GUIDE

## 2.3.2.3 Disabling the MCP2150

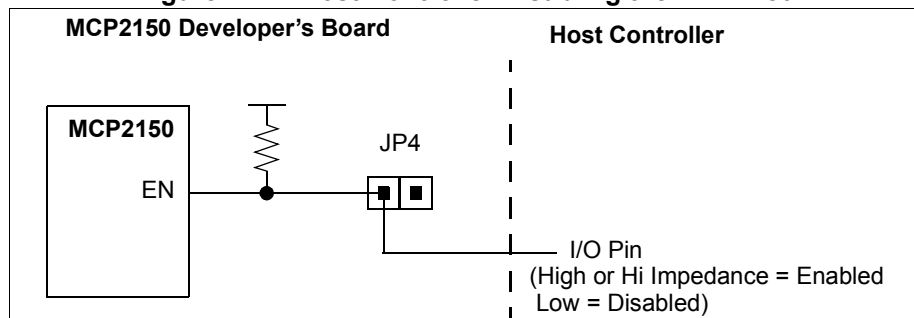
Figure 2.10 shows the jumper (JP3) which will enable or disable the MCP2150 device. When the MCP2150 is disabled, the device will consume less current.

**Figure 2.10: MCP2150 Enable/Disable**



In most cases, this jumper will be open. It may be closed to test system operation when the MCP2150 is disabled. The Host Controller board may control the operation of the MCP2150 by connecting a signal to the JP3 header as shown in Figure 2.11.

**Figure 2.11: Host Controller Disabling the MCP2150**



## 2.4 System Configurations

There are five configurations that one would use for initial evaluation of these two Developer's Boards. These configurations are:

<u>Developer's Board #1</u>		<u>Developer's Board #2</u>
1. MCP2120 Dev Board (ASCII)	↔	MCP2120 Dev Board (ASCII)
2. MCP2120 Dev Board (IR Driver)	→	MCP2120 Dev Board (IR Driver)
3. MCP2150 Dev Board (ASCII)	↔	MCP2120 Dev Board (IR Driver)
4. MCP2120 Dev Board (IR Driver)	→	IrDA standard port (Palm™ Pilot, cell phone, ...)
5. MCP2150 Dev Board (ASCII)	→	IrDA standard port (Palm Pilot, cell phone, ...)

The Host controller for each board can be either a Personal Computer (PC) or another system connected to the Host header. The PC operating system (OS) may be any desired OS that has a terminal emulation program which can connect to the serial port and can treat the IR port as a virtual serial port. For our tutorial, we will use the Windows 9x OS.

**Note 1:** Windows NT® 4.x (and lower) does not support the IrDA standard functionality. Third Party programs exist, but are not supported or recommended by Microsoft, so are also not recommended by Microchip.

**2:** Windows® 2000 does support the IrDA standard, but does not treat the IR port as a virtual serial port. This means that you cannot access the IR port as a serial port. This causes issues with some terminal emulation programs, such as Hyperterminal. Windows 2000 considers the IrDA port to be a network device. Applications that can access a network service through a network protocol (i.e. TCP/IP) can use the MCP2120 Developer's Board using the appropriate Windows 2000 driver.



## 2.4.4. Configuration 4

<u>Developer's Board #1</u>	<u>Developer's Board #2</u>
MCP2120 Dev Board (IR Driver)	→ IrDA standard port (Palm Pilot, cell phone, ...)

This configuration is used to evaluate the MCP2120 for an IrDA system, where the Host Controller is responsible for the IrDA protocol stack.

The MCP2120 Developer's Board interfaces to a PC running a terminal emulation program, such as Hyperterminal, that connects the IR port to a virtual serial port.

## 2.4.5. Configuration 5

<u>Developer's Board #1</u>	<u>Developer's Board #2</u>
MCP2150 Dev Board (ASCII)	→ IrDA standard port (Palm Pilot, cell phone, ...)

This configuration is used to evaluate the MCP2150 for adding the IrDA feature to a system. The Host controller only needs to send and receive the required ASCII data, while the MCP2150 handles the IrDA standard protocol stack.

The MCP2150 Developer's Board can have the host interface be from either the DB-9 (PC or other UART) or the Header.

# MCP2120/MCP2150 USER'S GUIDE

---

## 2.5 PC Requirements

The PC used has three main requirements. These are:

1. Standard Serial Port.
2. Terminal Emulation Program.
3. IrDA standard driver installed, which treats the IR port as a virtual serial port.

A non-legacy-free Intel compatible model with Windows 9x/2000 Operating System (OS) would meet these requirements. The Windows OS includes a Terminal Emulation program called Hyperterminal. Section 3.5 shows instructions to configure Hyperterminal and demonstrate the Developer's Boards.

**Note 1:** Windows® 2000 does support the IrDA standard, but does not treat the IR port as a virtual serial port. This means that you cannot access the IR port as a serial port. This causes issues with some terminal emulation programs, such as Hyperterminal. Windows 2000 considers the IrDA port to be a network device. Applications that can access a network service through a network protocol (i.e. TCP/IP) can use the MCP2120 Developer's Board using the appropriate Windows 2000 driver.



---

---

## Chapter 3. MCP2120 Tutorial

---

---

### 3.1 Introduction

This chapter covers a tutorial for using the MCP2120 Developer's Board.

### 3.2 Highlights

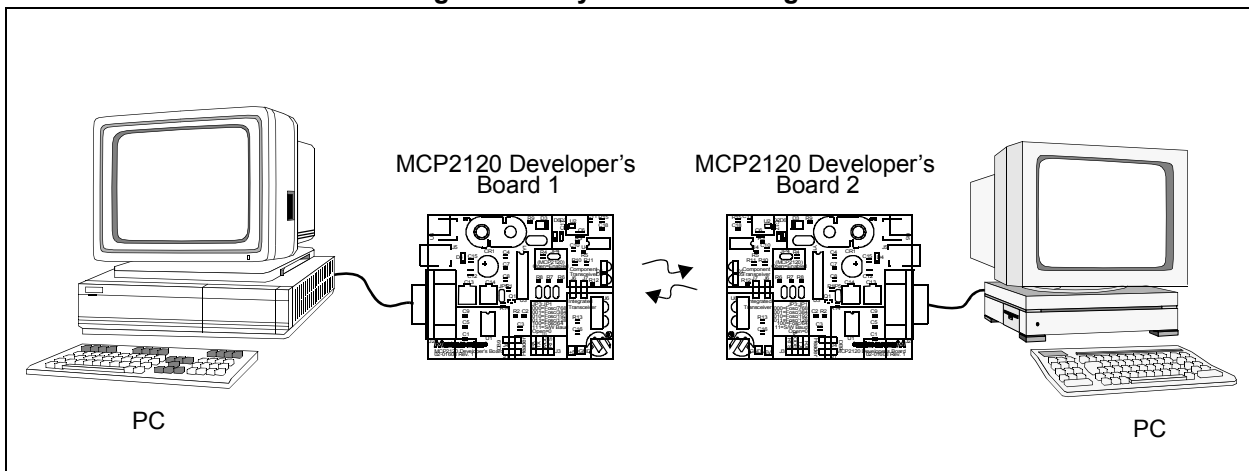
Topics covered in this chapter

- MCP2120 Tutorial Setup
- Hardware Setup
- Setting Up the Terminal Program
- Transmitting/Receiving Data

### 3.3 MCP2120 Tutorial Setup

This tutorial will use both MCP2120 Developer's Boards. The system will operate at 9600 Baud. Each board will be connected via the UART to the serial port of a personal computer (PC). This means that either two PCs are required, or a PC with two serial ports, as shown in Figure 3.1. It is assumed that two PCs will be used, and that each PC will have the Terminal Emulation program configured identically.

**Figure 3.1: System Block Diagram**



# MCP2120/MCP2150 USER'S GUIDE

## 3.4 Hardware Setup

### 3.4.1. Oscillator

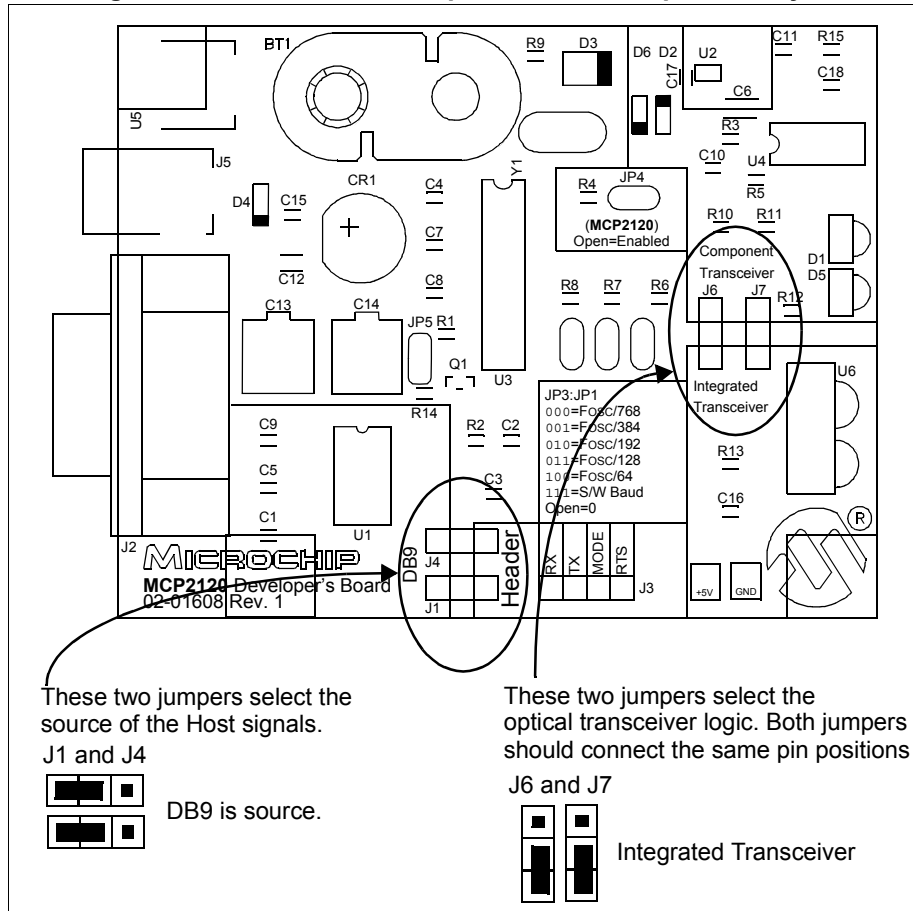
The crystal oscillator has pin receptacles to allow the changing of the MCP2120 oscillator frequency. For the tutorial, we will be using a crystal frequency of 7.3728 MHz. This crystal frequency is shipped in the kit.

### 3.4.2. Board Jumpers

The MCP2120 and MCP2150 Developer's Boards may use one of two host interfaces, the DB-9 interface to connect to a PC, or the header to connect to a controller board.

For the tutorial, the host signal will come from the DB-9 connector and the infrared data signals will interface to the Integrated Optical Transceiver. Figure 3.2 shows how the two 3-pin jumpers need to be connected for this configuration.

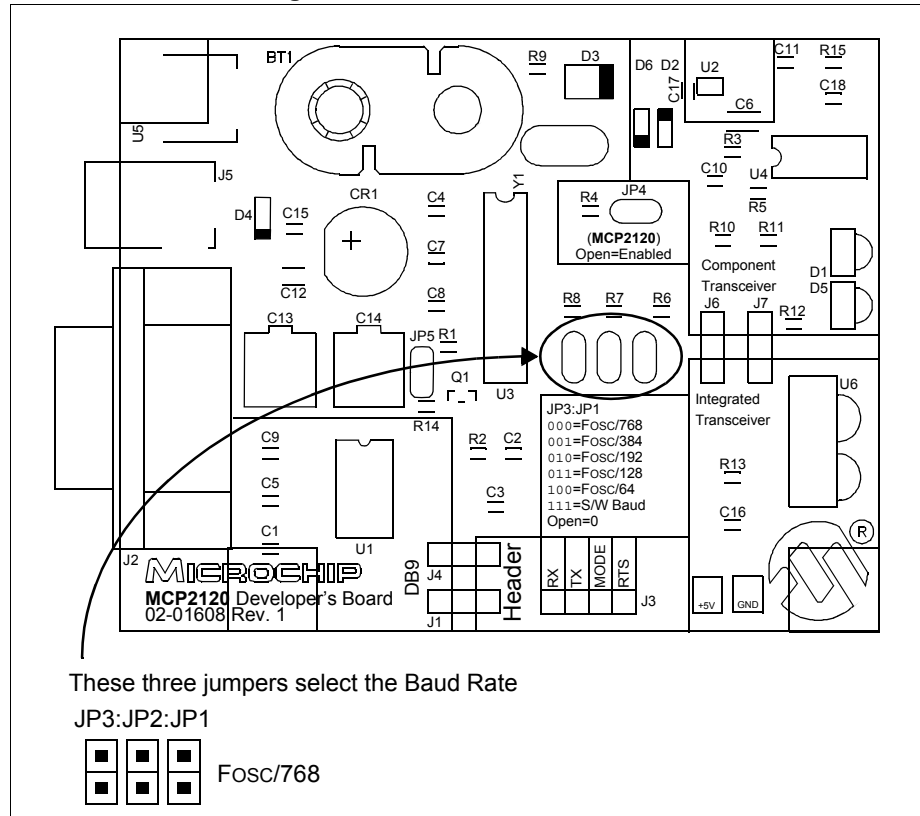
**Figure 3.2: MCP2120 Developer's Board Component Layout**



# MCP2120 Tutorial

Figure 3.3 shows the three Baud Rate Select jumpers (JP3:JP1) and the baud rate formula that is specified (baud rate dependant on MCP2120 operational frequency). The tutorial requires these jumpers to be open for a baud rate of 9600, when the crystal frequency is 7.3728 MHz.

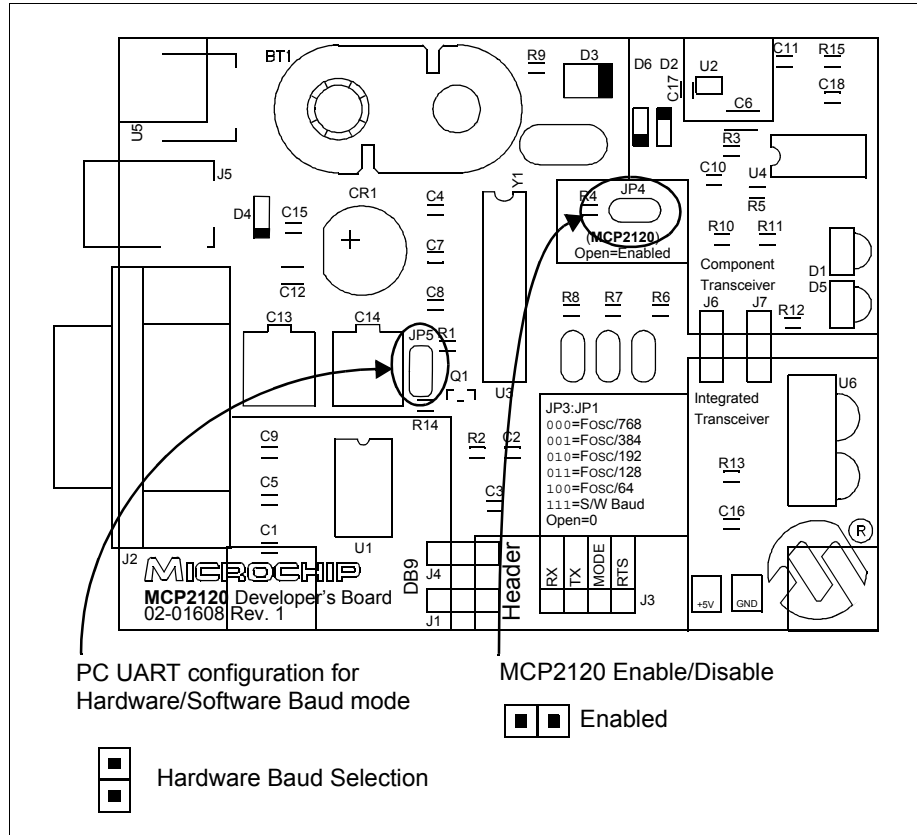
Figure 3.3: MCP2120 Baud Rate



# MCP2120/MCP2150 USER'S GUIDE

Figure 3.4 shows jumpers JP4 and JP5 and their state. For the tutorial, both of these jumpers are required to be open.

**Figure 3.4: MCP2120 UART Mode and Enable Mode**

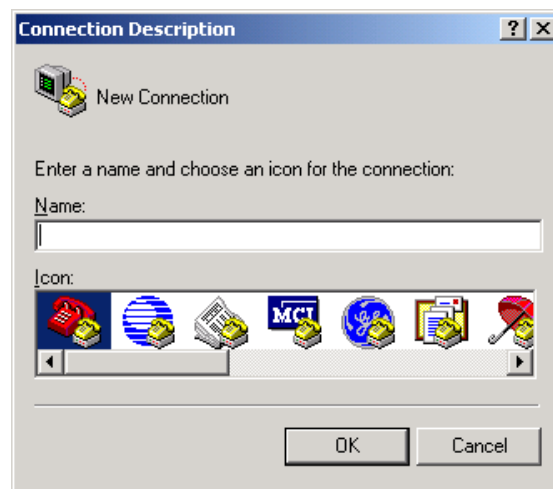


## 3.5 Setting Up the Terminal Program

Windows® 95 Operating System (OS) comes with a Terminal Emulation program called Hyperterminal. This tutorial uses this program to demonstrate the operation of the MCP2120/MCP2150 Developer's Kit boards.

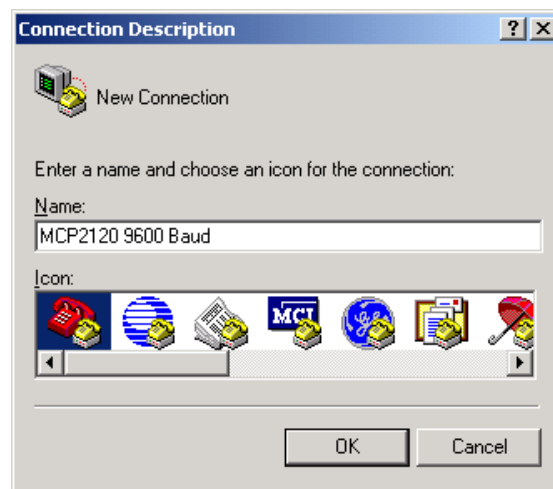
To open Hyperterminal, select *Start > Programs > Accessories* and select the Hyperterminal folder. Then double click the program file Hypertrm.exe. to start Hyperterminal. Figure 3.5 shows the initial screen once the Hyperterminal program is open. You will then need to select a name for this configuration.

**Figure 3.5: Hyperterminal Opening Screen**



For the initial test, we will set up the system to operate at 9600 baud. Type the name as shown in Figure 3.6 and select any icon. Click **OK**.

**Figure 3.6: Choosing Name and Icon**



# MCP2120/MCP2150 USER'S GUIDE

---

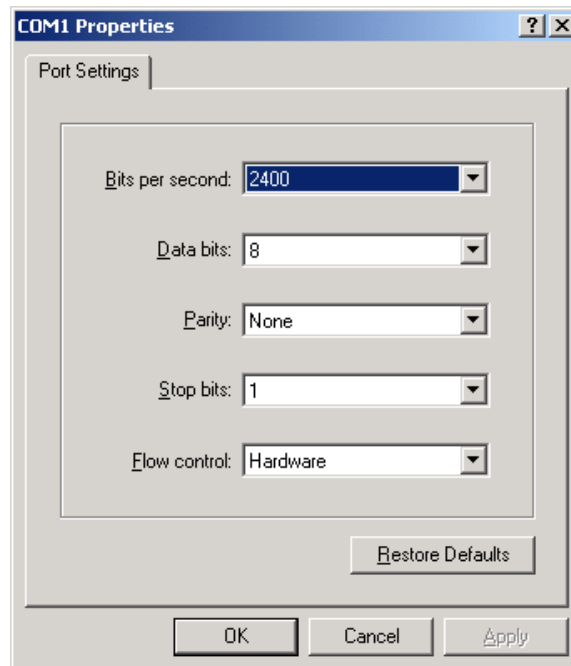
The menu in Figure 3.7 appears. You will need to select the port your serial port is on (Connect using). In our case, we are using COM1. Click **OK**.

**Figure 3.7: Selecting Communications (COM) Port**



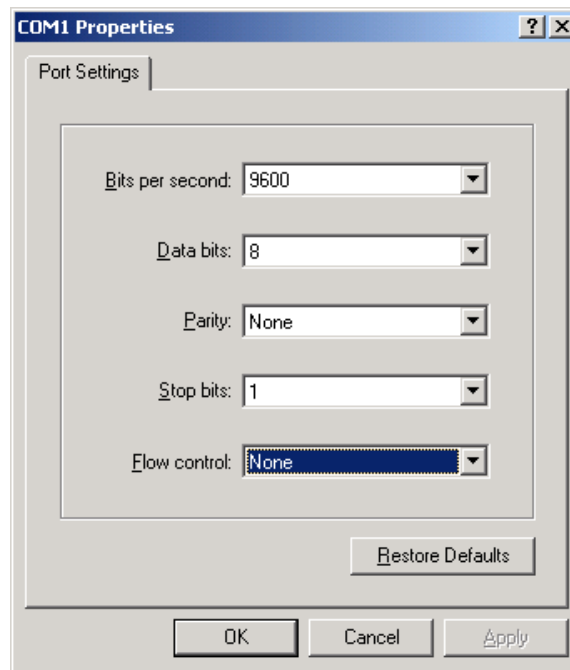
The Default settings for COM1 are displayed in Figure 3.8.

**Figure 3.8: Hyperterminal Default COM Port Settings**



The COM port settings need to be modified so the **Bits per second** is “9600” and the **Flow Control** is “None”, as shown in Figure 3.9. Click **OK** when done.

**Figure 3.9: Desired Hyperterminal COM Port Settings**

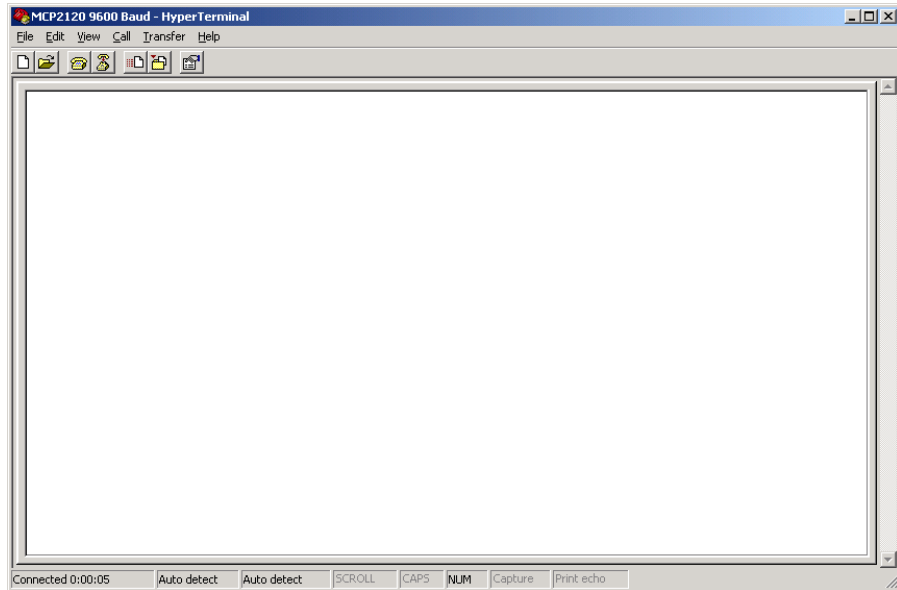


# MCP2120/MCP2150 USER'S GUIDE

---

The terminal window opens connected to the serial port as shown in Figure 3.10.

**Figure 3.10: Hyperterminal Screen After Initial Setup**



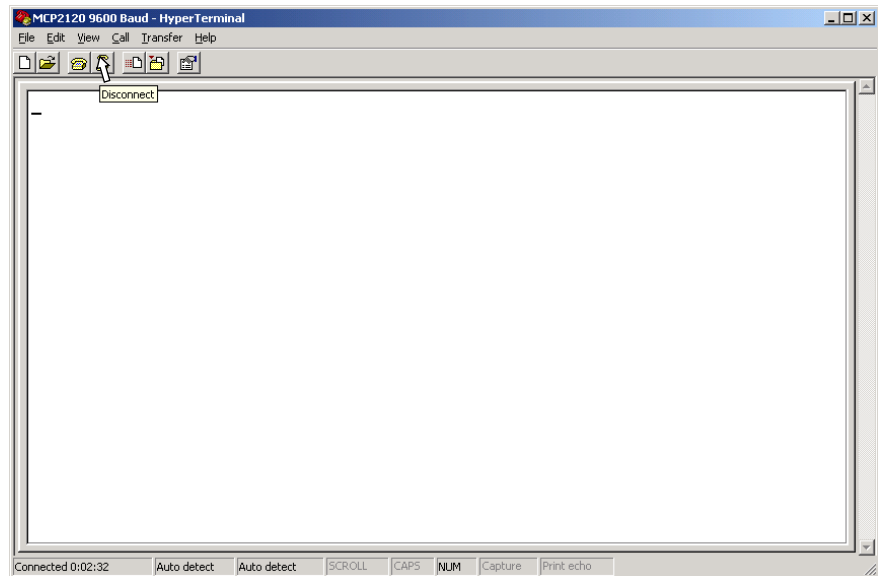


# MCP2120 Tutorial

---

When the characteristics of the Hyperterminal session need to be modified, the program should be disconnected from the port. To disconnect, click on the icon with the handset with the down arrow onto the phone base as shown in Figure 3.11.

**Figure 3.11: Disconnecting Hyperterminal**

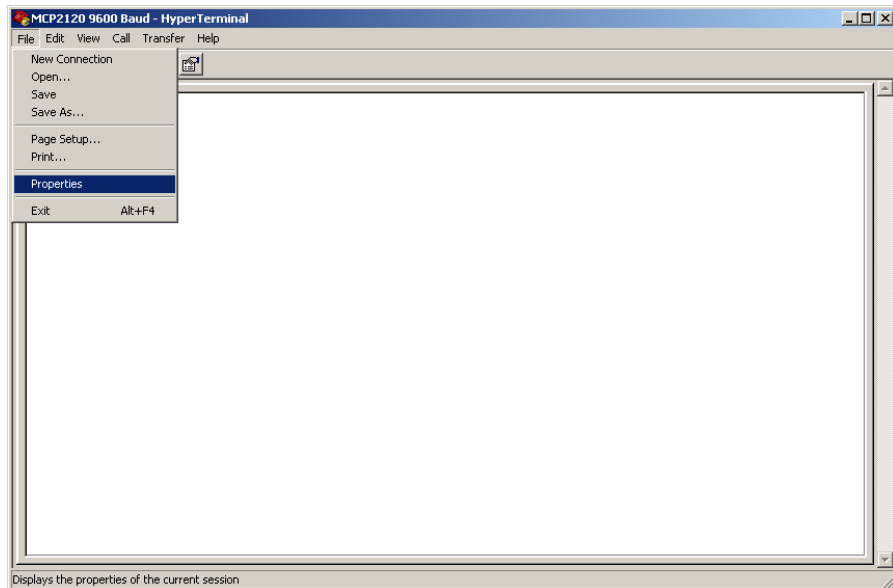


# MCP2120/MCP2150 USER'S GUIDE

---

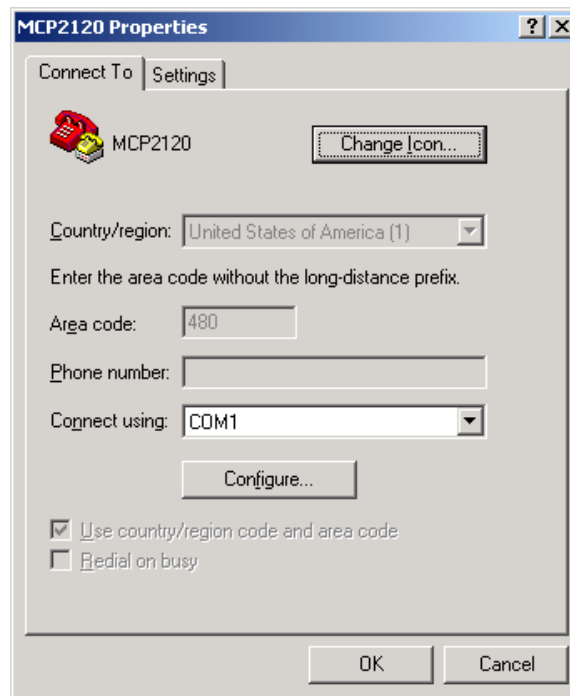
To modify the properties of this Hyperterminal session, select *File > Properties* as shown in Figure 3.12.

**Figure 3.12: Selecting Hyperterminal Properties Menu**



The Hyperterminal Properties window will appear as shown in Figure 3.13. Clicking the “**Configure...**” button will open the COM Properties window shown in Figure 3.14.

**Figure 3.13: Hyperterminal Properties Menu (Connect To)**

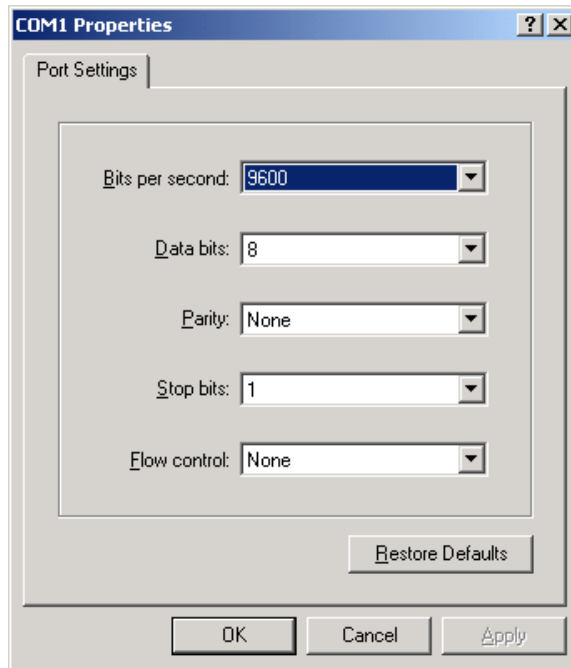


# MCP2120/MCP2150 USER'S GUIDE

---

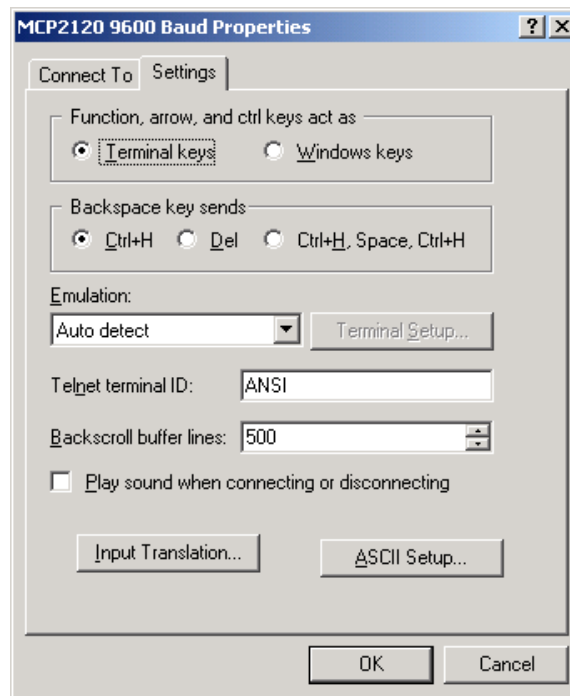
Verify the settings are as desired. If not, change the settings to match the settings in Figure 3.14. Click the **OK** button and you will return to the window shown in Figure 3.13.

**Figure 3.14: Configure Connection Menu**



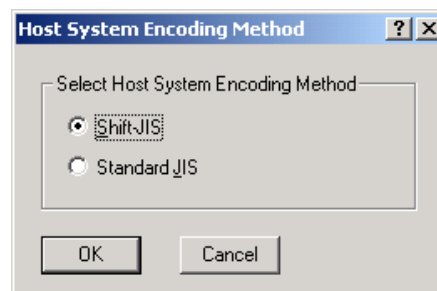
Click on the **Settings** tab. Figure 3.15 shows the default settings. The “**Backscroll buffer lines**” setting can be modified to **0**, if desired. This will make viewing information in the Hyperterminal window more convenient.

**Figure 3.15: Hyperterminal Properties Menu (Settings)**



Clicking on the “**Input Translation...**” button will bring up the following window. Click **Cancel** to close this window.

**Figure 3.16: Input Translation Menu**

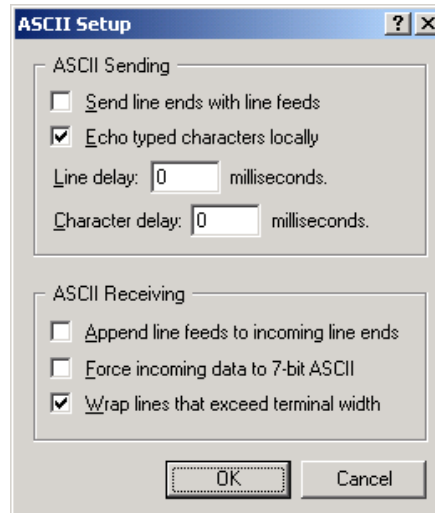


# MCP2120/MCP2150 USER'S GUIDE

---

Clicking on the “**ASCII Setup...**” button will bring up the ASCII Setup window. Make the changes as shown in Figure 3.17 by checking the “**Echo typed characters locally**” setting. Click **OK** to apply these changes and close the window.

**Figure 3.17: ASCII Setup Menu**



## 3.6 Transmitting/Receiving Data

Now both PCs should have their Hyperterminal program running in the connected mode with the same COM port settings. See Figure 3.9.

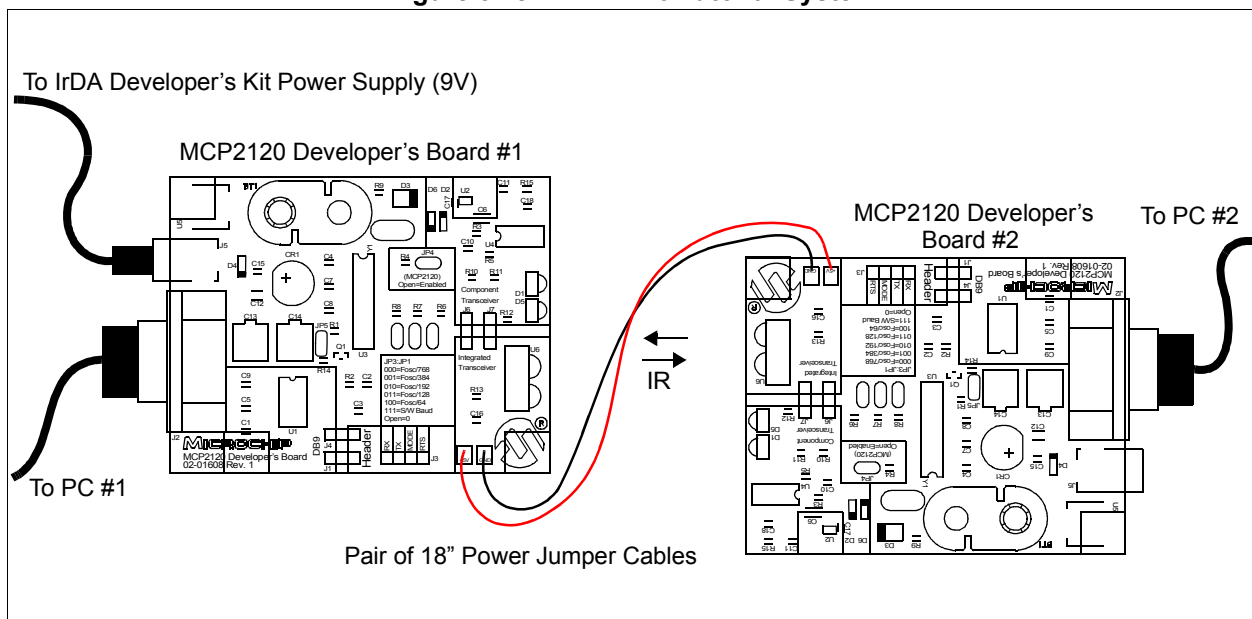
Each MCP2120 Developer's Board should be powered. Use the pair of 18" (45 cm) power jumper cables to power MCP2120 Developer's Board #2 from MCP2120 Developer's Board #1. Optionally, MCP2120 Developer's Board #2 could be powered from a 9V battery. When the MCP2120 Developer's Board is powered, the green LED (labeled D3) will be on.

Each MCP2120 Developer's Board should be connected to their respective PC serial port, so that Hyperterminal can communicate to the board.

The MCP2120 Developer's Board should be oriented so that the integrated optical transceivers are aligned with each other (as shown in Figure 3.18). For the initial communication between the two boards, the MCP2120 Developer's Boards should be approximately 6" (15 cm) apart.

Type a string of characters in the Hyperterminal window on PC #1. This same character string should appear in the Hyperterminal window of PC #2. Typing a string of characters in the Hyperterminal window on PC #2 should have the same character string appear in the Hyperterminal window of PC #1. Congratulations! You may now start modifying the system to evaluate/test the operation of the MCP2120 and MCP2120 Developer's Board.

**Figure 3.18: MCP2120 Tutorial System**



# MCP2120/MCP2150 USER'S GUIDE

---

## 3.6.1. System Debug Tips

If you are not getting communications between the two boards, some debugging is in order. Here are some suggested steps:

- Verify that the Hyperterminal programs are set up correctly
- Verify that both Hyperterminal sessions are “connected”
- Verify that the MCP2120 Developer’s Boards are powered
- Verify that the MCP2120 Developer’s Boards are set up correctly

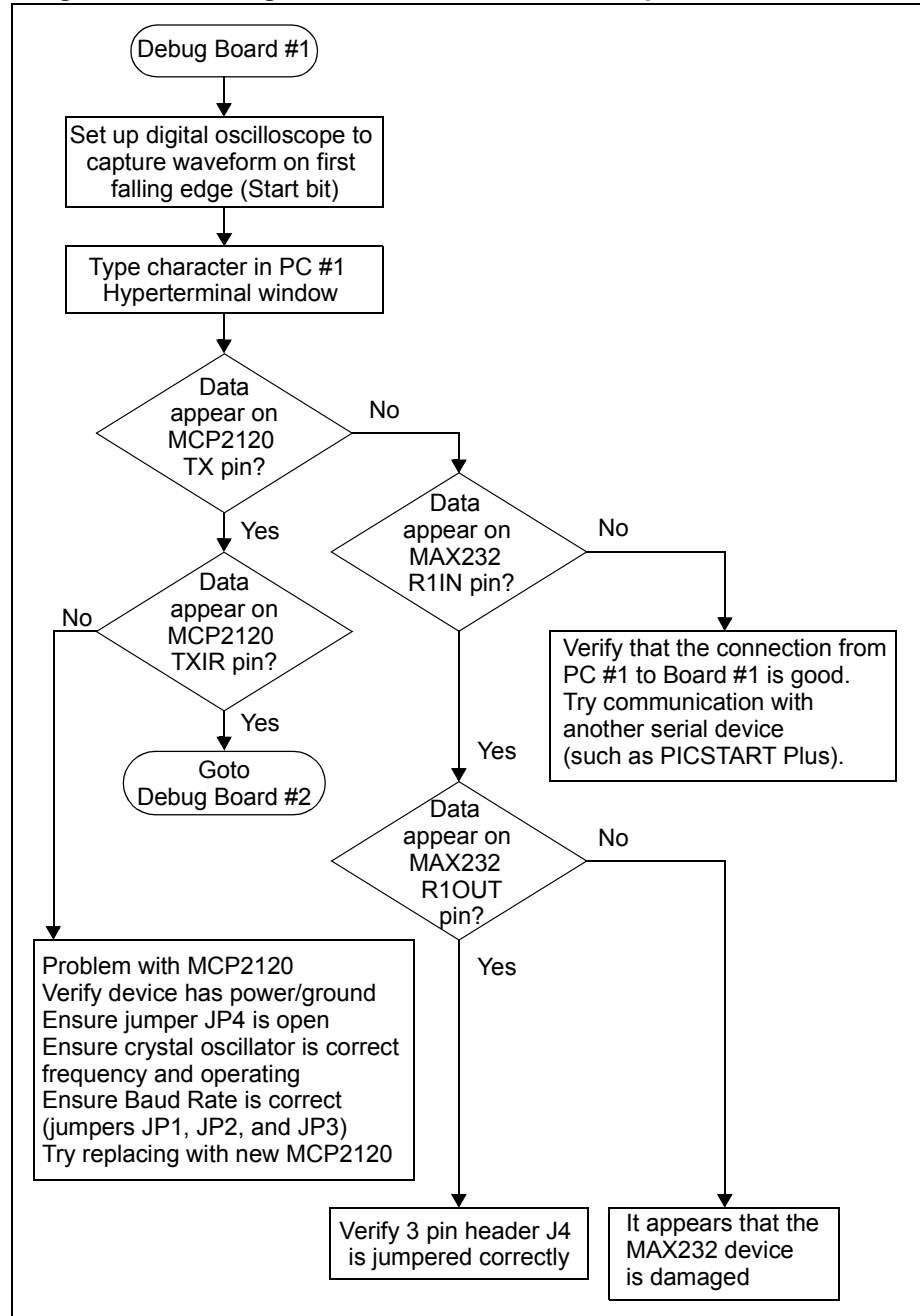
If that review does not locate the issue, then more in depth debugging is required. These steps require an oscilloscope. A digital 4-channel oscilloscope is recommended. By typing a data byte into Hyperterminal on the PC, the oscilloscope can be used to determine where in the system the data byte was “lost”.

Figure 3.19 and Figure 3.20 shows a debug flow to help troubleshoot the communications between the two MCP2120 Developer’s Boards. Figure 3.19 shows the steps for the transmit side of System #1 (PC #1 and MCP2120 Developer’s Board #1). If it appears that the TXIR signal is correct, then the receive side needs to be validated. Figure 3.20 shows the steps for the receive side of System #2 (PC #2 and MCP2120 Developer’s Board #2).

These steps can then be used to debug the transmit side of System #2 and the receive side of System #1.

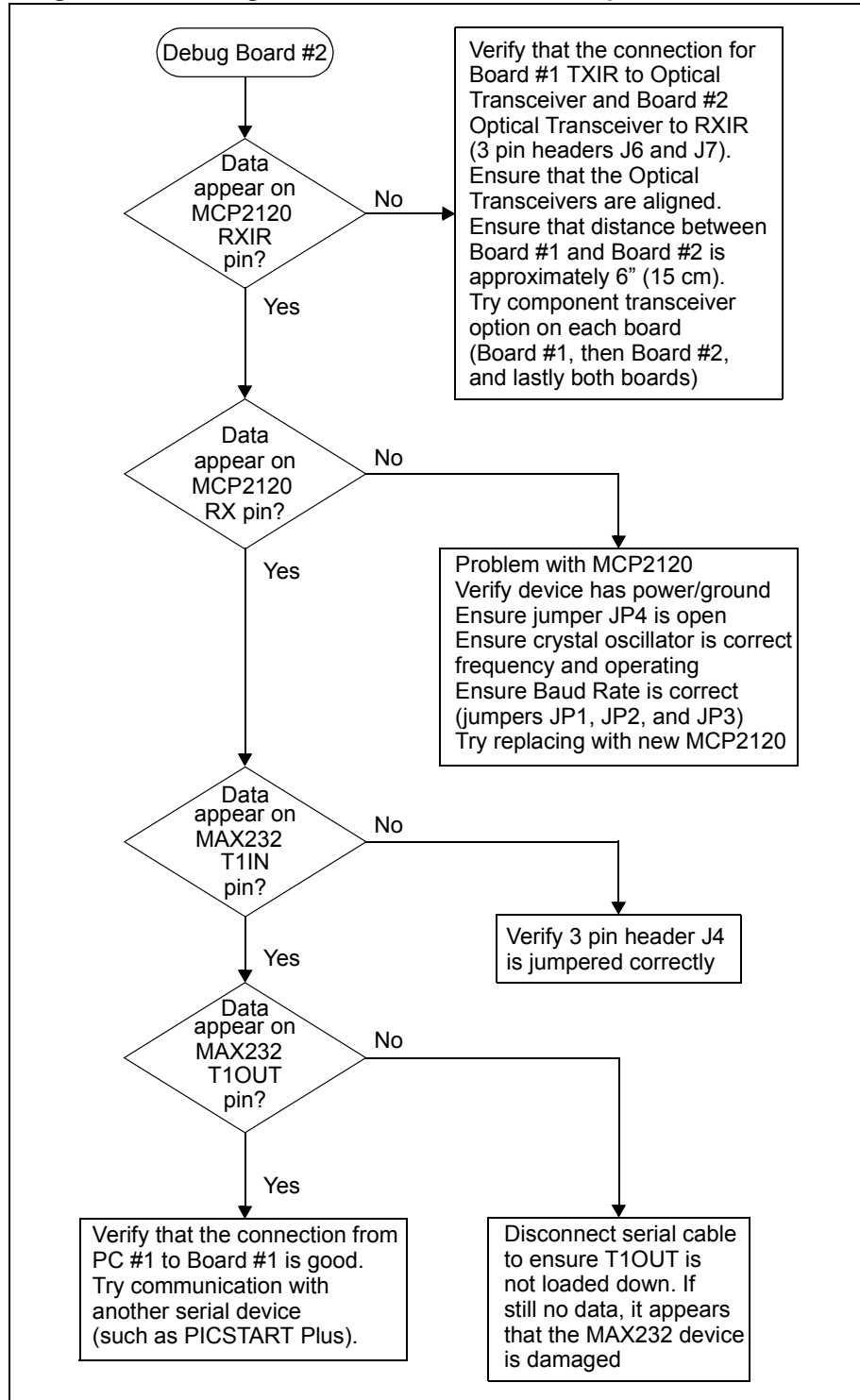


Figure 3.19: Debug Flowchart - MCP2120 Developer's Board #1 Side



# MCP2120/MCP2150 USER'S GUIDE

Figure 3.20: Debug Flowchart - MCP2120 Developer's Board #2 Side



---

---

## **Chapter 4. MCP2150 Tutorial**

---

---

### **4.1 Introduction**

This chapter covers a tutorial for using the MCP2150 Developer's Board.

### **4.2 Highlights**

Topics covered in this chapter

- MCP2150 Tutorial

### **4.3 MCP2150 Tutorial**

This tutorial was not available for this revision of the MCP2120/MCP2150 Developer's Kit User's Guide. Please check in the Development Tools section of the Microchip web site ([www.microchip.com](http://www.microchip.com)) for revision B of the User's Guide. Revision B is planned to include the tutorial on using the MCP2150 Developer's Board with an MCP2120 Developer's Board.

Information on Microchip Development Tools can be located on the web site by using the Navagate window and selecting *Developer's Tool Box > Development Tools*.

# MCP2120/MCP2150 USER'S GUIDE

---

---

NOTES:

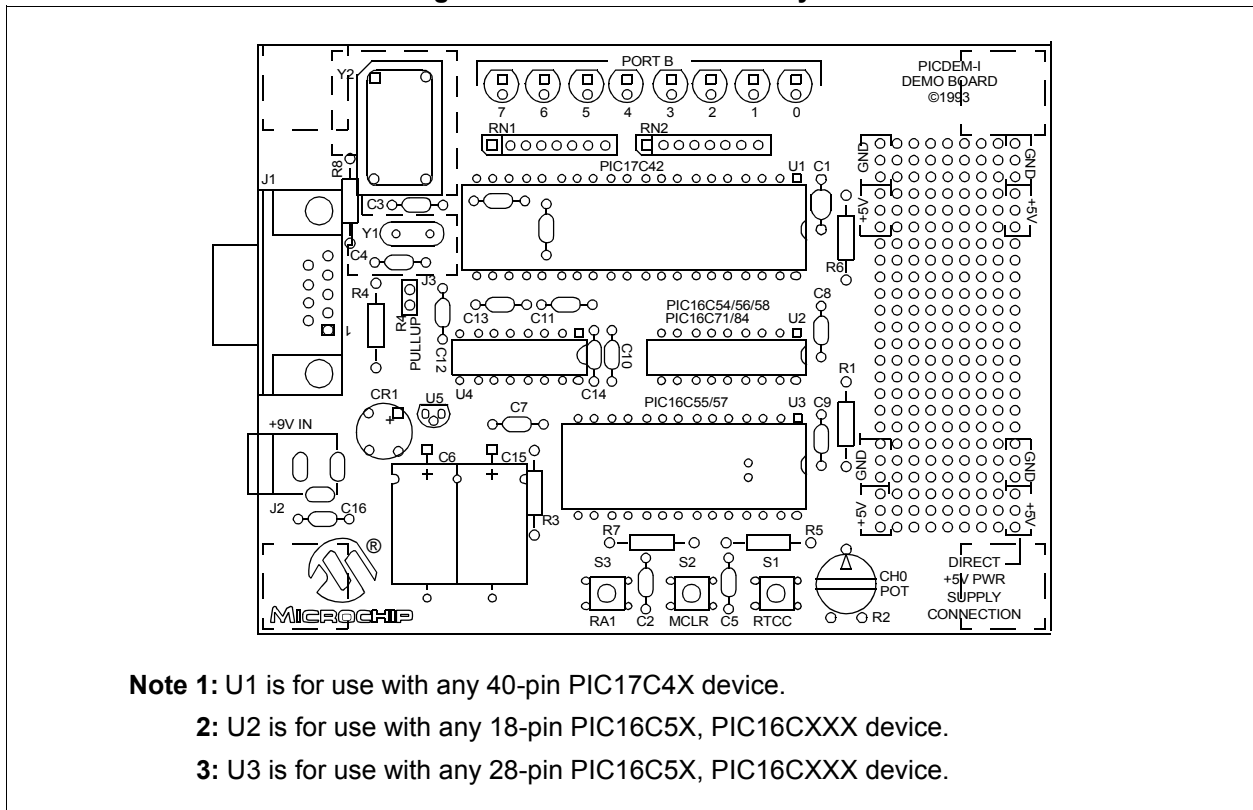
**Chapter 5. Using a PICDEM™ 1 or PICDEM™ 2 Board as Host**

**5.1 Using the PICDEM 1 Board**

The PICDEM™ 1 board may be used as the host controller in an IrDA standard compatible system. PortB can be used to display received characters, while any of the other ports would be used for the UART and control signals. A PICmicro® microcontroller may be selected that has a hardware UART, or the UART functionality may be implemented in software.

Figure 5.1 shows the parts layout (silk-screen) for the PICDEM 1 board.

**Figure 5.1: PICDEM 1 Parts Layout**



# MCP2120/MCP2150 USER'S GUIDE

---

## 5.1.1. Application Notes

There are two Application Notes that show how to use the PICDEM 1 Board as a Host controller.

AN756, “*Using the MCP2120 for Infrared Communication*”, DS00756, uses the MCP2120 Developer’s Board and has two code examples. The first is using a PIC16F84 with the MCP2120 Developer’s Board in Hardware Baud mode. In this mode, only two signals need to be interfaced. The RX and TX signal. The second code example is also using a PIC16F84 with the MCP2120 Developer’s Board in Software Baud mode. In this mode, four signals need to be interfaced; RX, TX, MODE, and RTS (used to reset the MCP2120).

AN758, “*Using the MCP2150 to Add IrDA Standard Wireless Connectivity*”, DS00758, uses the MCP2150 Developer’s Board and has one code example. For this application, seven signals need to be interfaced; RX, TX, DSR, DTR, CTS, RTS, and CD.

## 5.1.2. For Additional PICDEM 1 Information

Additional information can be located on the Microchip web site ([www.microchip.com](http://www.microchip.com)). Information on Microchip Development Tools can be located by using the Navigate window and selecting *Developer’s Tool Box > Development Tools*.

The PICDEM 1 User’s Guide literature number is DS33015, and the PICDEM 1 kit can be ordered with Part Number DM163001.

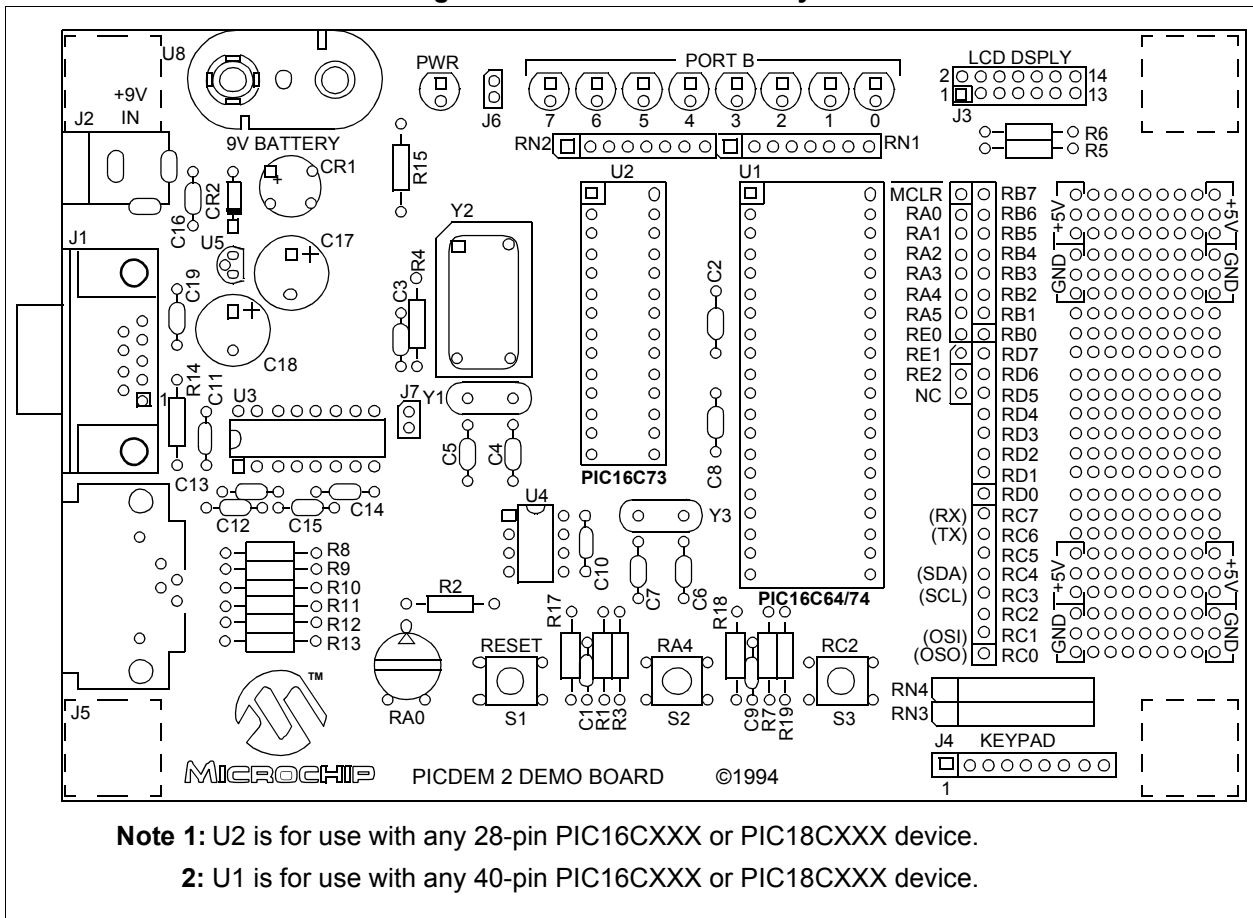
# Using a PICDEM™ 1 or PICDEM™ 2 Board as Host

## 5.2 Using the PICDEM 2 Board

The PICDEM™ 2 board may be used as the host controller in an IrDA standard compatible system. PortB can be used to display received characters, while any of the other ports would be used for the UART and control signals. A PICmicro microcontroller may be selected that has a hardware UART, or the UART functionality may be implemented in software.

Figure 5.2 shows the parts layout (silk-screen) for the PICDEM 2 board.

**Figure 5.2: PICDEM 2 Parts Layout**



# MCP2120/MCP2150 USER'S GUIDE

---

---

## 5.2.1. Application Notes

Currently there are no Application Notes that use the PICDEM 2 Board as a Host controller. The examples shown for the PICDEM 1 board can be easily modified to have the PICDEM 2 board operate as the Host controller.

## 5.2.2. For Additional PICDEM 2 Information

Additional information can be located on the Microchip web site ([www.microchip.com](http://www.microchip.com)). Information on Microchip Development Tools can be located by using the Navagate window and selecting *Developer's Tool Box > Development Tools*.

The PICDEM 2 User's Guide literature number is DS30374, and the PICDEM 2 kit can be ordered with Part Number DM163002.



---

---

## Appendix A. Hardware Detail

---

---

The MCP2120/MCP2150 Developer's Board hardware is intended to illustrate the ease of use of Microchip's infrared data communication solutions. The Developer's Board features the following hardware elements:

### A.1 Power Supply

There are three ways to supply power to the MCP2120/MCP2150 Developer's Board:

- A 9V battery can be plugged into BT1.
- A 9V, 750 mA unregulated AC or DC supply can be plugged into J5.
- A +5V, 750 mA regulated DC supply can be connected to the two pins provided, labled +5V and GND. A pair of 18" (45 cm) cables are provided to allow one board to power another.

### A.2 Power Indicator

One green LED indicates whether there is power applied to the MCP2120 and MCP2150 Developer Boards (LED lit) or not (LED off).

### A.3 RS-232 Serial Port

#### A.3.1 MCP2120 Developer's Board

A MAX232 compatible level shifting IC has been provided with all necessary hardware to support connection of an RS-232 host through the DB-9 connector. The port can be connected to a PC using a straight through cable. Refer to the MCP2120 Data Sheet for more information.

#### A.3.2 MCP2150 Developer's Board

A MAX3238E compatible level shifting IC has been provided with all necessary hardware to support connection of a RS-232 host through the DB-9 connector. The port can be connected to a PC using a straight through cable. Refer to the MCP2120 Data Sheet (DS21618) for more information.

# MCP2120/MCP2150 USER'S GUIDE

## A.4 Jumpers

Jumpers are used to allow the Developer's Board to be configured into the different modes that are possible. These modes include:

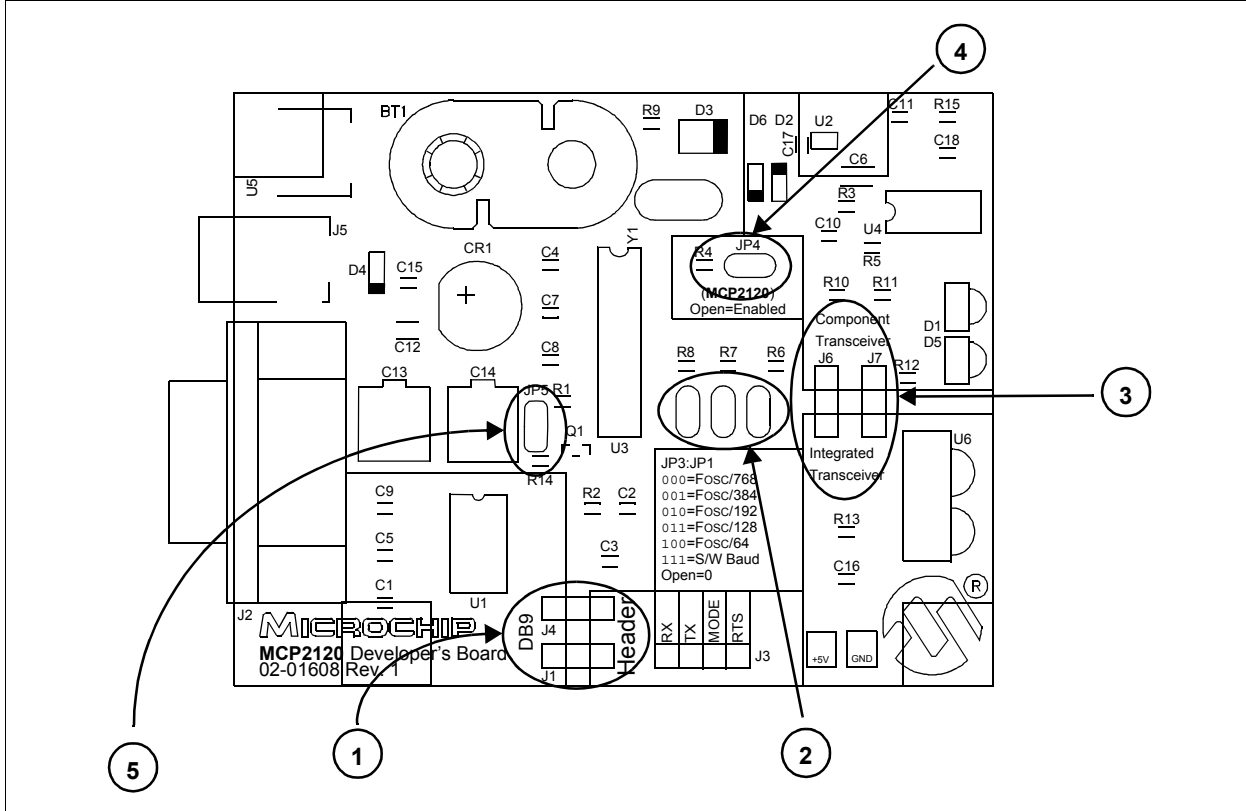
- Selection of Baud Rate
- Source of Host signals
- Source of Optical Transceiver signals
- Device Enable signal for power down operation

### A.4.1 MCP2120 Developer's Board

The MCP2120 Developer's Board has the following jumpers:

1. Two jumpers to select source of UART signals. Either RS-232C socket or the four-pin header.
2. Three jumpers to select desired baud rate.
3. Two jumpers to select IR Transceiver options.
4. Jumper to disable device operation.
5. Jumper for Software Baud control when using RS-232C interface.

Figure A.1: MCP2120 Developer's Board Hardware

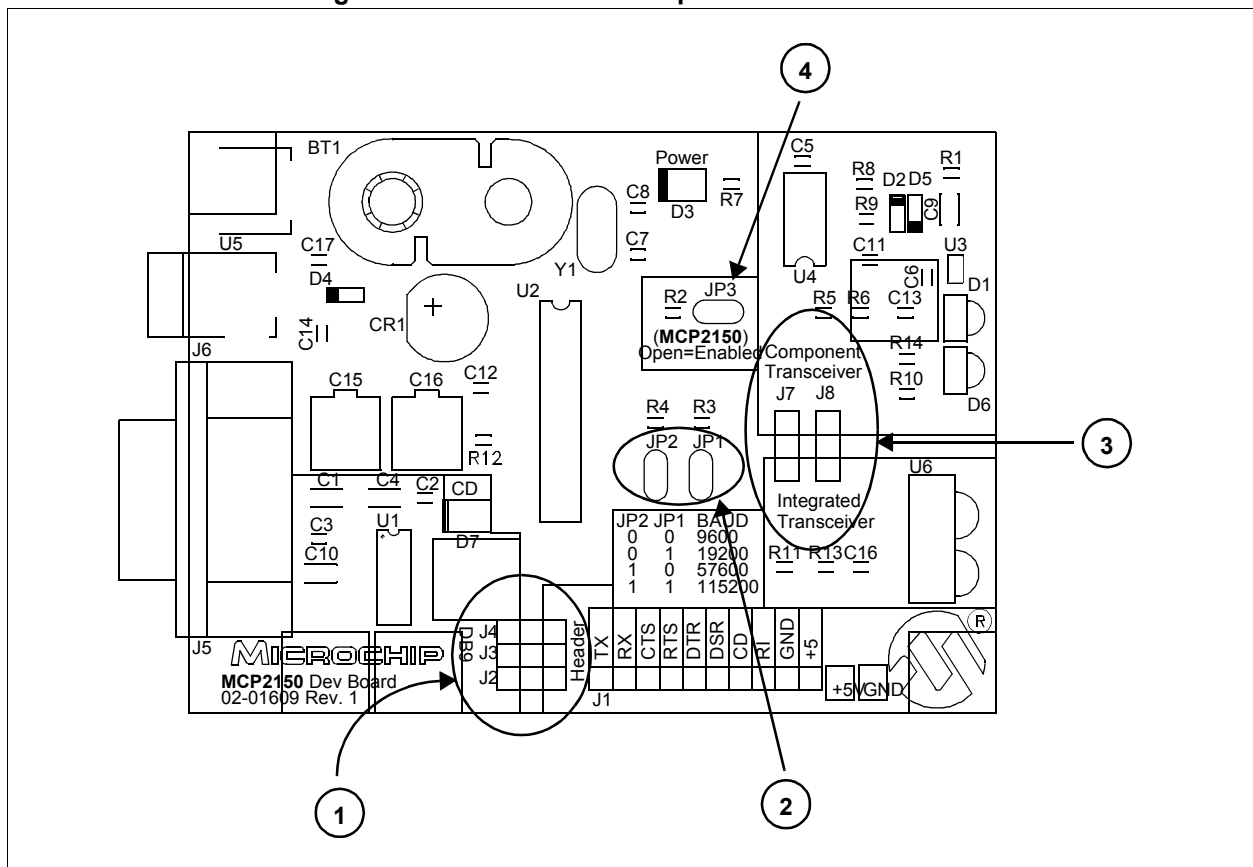


## A.4.2 MCP2150 Developer's Board

The MCP2150 Developer's Board has the following jumpers:

1. Three jumpers to select source of UART signals. Either RS-232C socket or the eight-pin header.
2. Two jumpers to select desired baud rate.
3. Two jumpers to select IR Transceiver options.
4. Jumper to disable device operation.

Figure A.2: MCP2150 Developer's Board Hardware



# MCP2120/MCP2150 USER'S GUIDE

## A.5 Oscillator Options

The MCP2120 can be operated at different frequencies, while the MCP2150 only operates at a single fixed frequency.

### A.5.1 MCP2120 Developer's Board

The MCP2120 Developer's Board crystal has pin receptacles so that crystal frequencies can easily be changed. Table A.1 shows the baud rates for a given crystal frequency, based on the state of the BAUD2:BAUD0 pins.

**Table A.1: Crystal Frequency / Baud Rate**

BAUD2:BAUD0	Bit Rate	Fosc Frequency (MHz)						
		0.6144 <sup>(1)</sup>	2.000	3.6864	4.9152	7.3728	14.7456 <sup>(2)</sup>	20.000 <sup>(2)</sup>
000	Fosc / 768	800	2604	4800	6400	9600	19200	26042
001	Fosc / 384	1600	5208	9600	12800	19200	38400	52083
010	Fosc / 192	3200	10417	19200	25600	38400	78600	104167
011	Fosc / 128	4800	15625	28800	38400	57600	115200	156250
100	Fosc / 64	9600	31250	57600	78600	115200	230400	312500

**Note 1:** An external clock is recommended for frequencies below 2 MHz.

**Note 2:** For frequencies above 7.5 MHz, the TXIR pulse width (MCP2120 Data Sheet electrical specification parameter IR121) will be shorter than the minimum pulse width of 1.6  $\mu$ s in the IrDA standard specification.

### A.5.2 MCP2150 Developer's Board

The MCP2150 Developer's Board requires a fixed frequency crystal (11.0592 MHz).

**Table A.2: Crystal Frequency / Baud Rate**

BAUD1:BAUD0	Bit Rate	Fosc Frequency - 11.0592 MHz
00	Fosc / 1152	9600
01	Fosc / 576	19200
10	Fosc / 192	57600
11	Fosc / 96	115200

## A.6 Board Layout

Figure A.3 shows the component layout (silkscreen) for the MCP2120 Board.

**Figure A.3: MCP2120 Developer's Board Component Layout**

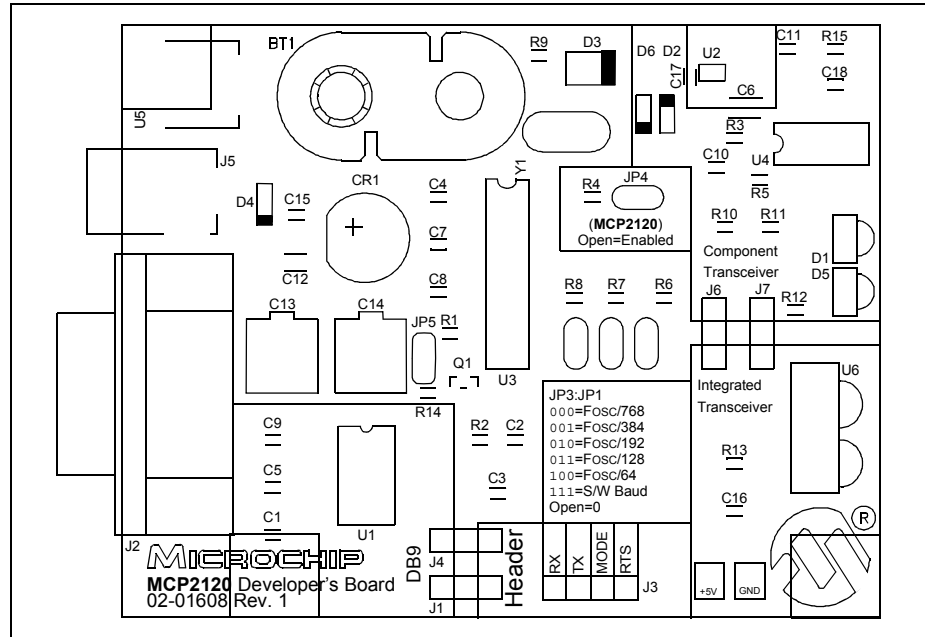
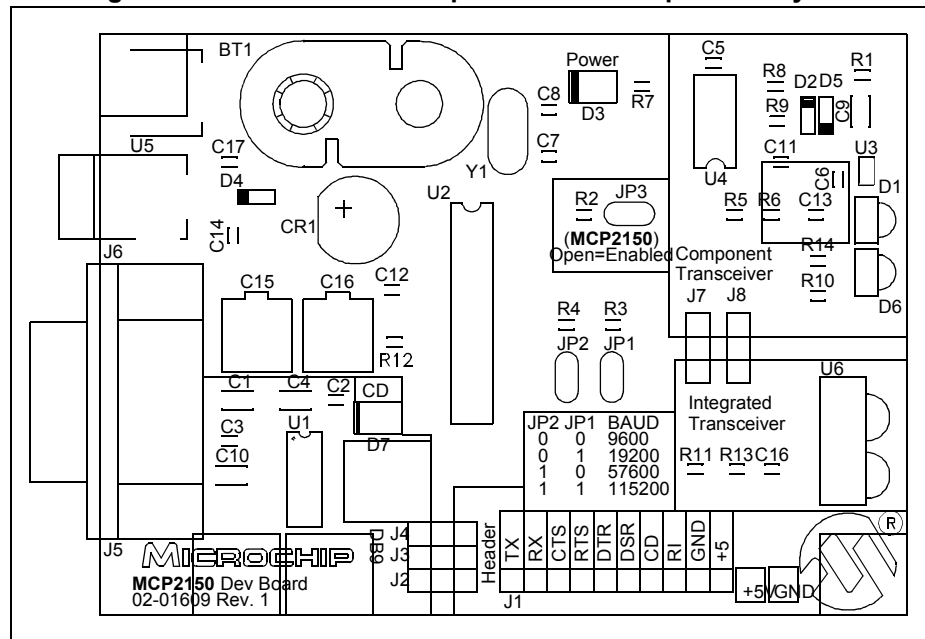


Figure A.4 shows the component layout (silkscreen) for the MCP2150 Board.

**Figure A.4: MCP2150 Developer's Board Component Layout**



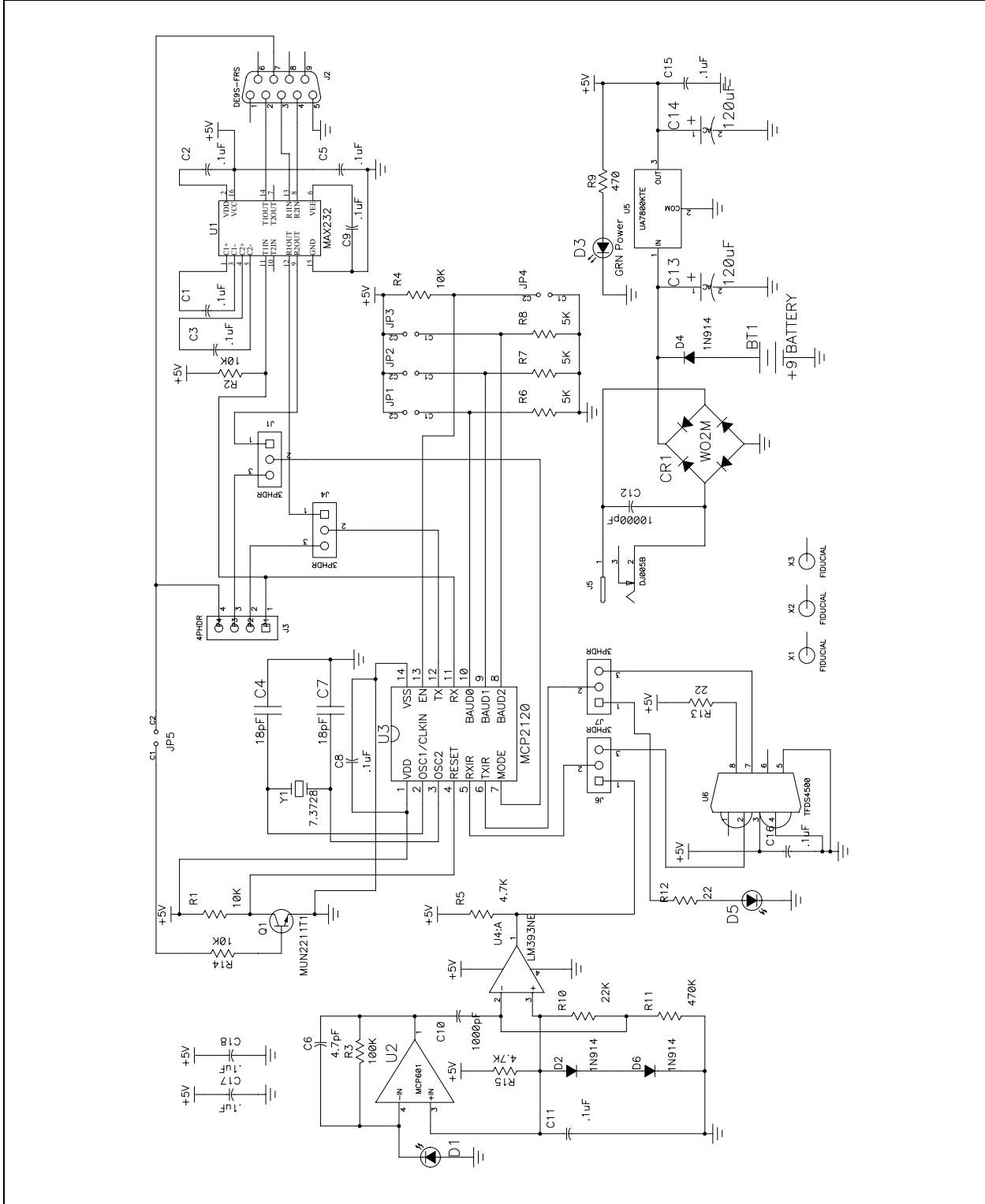
# MCP2120/MCP2150 USER'S GUIDE

---

## A.7 Schematics

Figure A.5 shows the schematic for the MCP2120 Developer's Board.  
Figure A.6 shows the schematic for the MCP2150 Developer's Board.

Figure A.5: MCP2120 Developer's Board Schematic









# MCP2120/MCP2150 USER'S GUIDE

---

---

## Revision History

---

---

### DESCRIPTION OF REVISION

This section covers the major changes to this document between the revisions. These changes include the corrections and enhancements that have been implemented.

#### **Current Revision (Revision A)**

Initial release of this document

# MCP2120/MCP2150 USER'S GUIDE

---

NOTES:



# MCP2120/MCP2150 USER'S GUIDE

## Index

<b>B</b>		
Board Layout:		
MCP2120 Developer's Board Component Layout .....	49	
MCP2150 Developer's Board Component Layout .....	49	
<b>D</b>		
Disabling the MCP2120 .....	11	
Disabling the MCP2150 .....	16	
<b>H</b>		
Hardware Setup:		
Board Jumpers .....	22	
Oscillator .....	22	
<b>J</b>		
Jumpers:		
MCP2120 Developer's Board .....	46	
MCP2150 Developer's Board .....	47	
<b>M</b>		
MCP2120 Developer's Board:		
Component Transceiver .....	8	
Disable device operation .....	6	
Hardware Baud selection .....	6	
Integrated Transceiver .....	8	
Ir Transceiver .....	6	
Selecting Baud Rate .....	9	
Software Baud selection .....	6	
UART Interface .....	6	
MCP2150 Developer's Board:		
Component Transceiver .....	14	
Hardware Baud selection .....	12	
Ir Transceiver .....	12, 14	
Selecting Baud Rate .....	15	
UART Interface .....	12	
<b>O</b>		
Oscillator Options:		
MCP2120 Developer's Board .....	48	
MCP2150 Developer's Board .....	48	
<b>P</b>		
PC Requirements .....	20	
PICDEM 1 Board .....	41	
PICDEM 2 Board .....	43	
		Power Supply .....
		45
<b>R</b>		
Reference Documents .....	3	
<b>S</b>		
Sample Devices .....	3	
Schematics .....	50	
Serial Port .....	45	
System Configurations .....	17	
<b>T</b>		
Terminal Program .....	25	
Tutorial Setup .....	21, 39	
<b>U</b>		
UART Mode .....	10	

# **MCP2120/MCP2150 USER'S GUIDE**

---

---

**NOTES:**

---

---

**NOTES:**

# MCP2120/MCP2150 USER'S GUIDE

---

NOTES:

# MCP2120/MCP2150 USER'S GUIDE

Information contained in this publication regarding device applications and the like is intended through suggestion only and may be superseded by updates. It is your responsibility to ensure that your application meets with your specifications. No representation or warranty is given and no liability is assumed by Microchip Technology Incorporated with respect to the accuracy or use of such information, or infringement of patents or other intellectual property rights arising from such use or otherwise. Use of Microchip's products as critical components in life support systems is not authorized except with express written approval by Microchip. No licenses are conveyed, implicitly or otherwise, under any intellectual property rights.

## Trademarks


The Microchip name and logo, the Microchip logo, PIC, PICmicro, PICMASTER, PICSTART, PRO MATE, KEELOQ, SEEVAL, MPLAB and The Embedded Control Solutions Company are registered trademarks of Microchip Technology Incorporated in the U.S.A. and other countries.

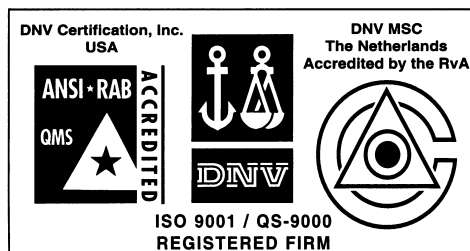
Total Endurance, ICSP, In-Circuit Serial Programming, Filter-Lab, MXDEV, microID, *FlexROM*, *fuzzyLAB*, MPASM, MPLINK, MPLIB, PICC, PICDEM, PICDEM.net, ICEPIC, Migratable Memory, FanSense, ECONOMONITOR, Select Mode and microPort are trademarks of Microchip Technology Incorporated in the U.S.A.

Serialized Quick Term Programming (SQTP) is a service mark of Microchip Technology Incorporated in the U.S.A.

All other trademarks mentioned herein are property of their respective companies.

© 2001, Microchip Technology Incorporated, Printed in the U.S.A., All Rights Reserved.

 Printed on recycled paper.



*Microchip received QS-9000 quality system certification for its worldwide headquarters, design and wafer fabrication facilities in Chandler and Tempe, Arizona in July 1999. The Company's quality system processes and procedures are QS-9000 compliant for its PICmicro® 8-bit MCUs, KEELOQ® code hopping devices, Serial EEPROMs and microperipheral products. In addition, Microchip's quality system for the design and manufacture of development systems is ISO 9001 certified.*



# MICROCHIP

## WORLDWIDE SALES AND SERVICE

### AMERICAS

#### Corporate Office

2355 West Chandler Blvd.  
Chandler, AZ 85224-6199  
Tel: 480-792-7200 Fax: 480-792-7277  
Technical Support: 480-792-7627  
Web Address: <http://www.microchip.com>

#### Rocky Mountain

2355 West Chandler Blvd.  
Chandler, AZ 85224-6199  
Tel: 480-792-7966 Fax: 480-792-7456

#### Atlanta

500 Sugar Mill Road, Suite 200B  
Atlanta, GA 30350  
Tel: 770-640-0034 Fax: 770-640-0307

#### Austin - Analog

8303 MoPac Expressway North  
Suite A-201  
Austin, TX 78759  
Tel: 512-345-2030 Fax: 512-345-6085

#### Boston

2 Lan Drive, Suite 120  
Westford, MA 01886  
Tel: 978-692-3848 Fax: 978-692-3821

#### Boston - Analog

Unit A-8-1 Millbrook Tarry Condominium  
97 Lowell Road  
Concord, MA 01742  
Tel: 978-371-6400 Fax: 978-371-0050

#### Chicago

333 Pierce Road, Suite 180  
Itasca, IL 60143  
Tel: 630-285-0071 Fax: 630-285-0075

#### Dallas

4570 Westgrove Drive, Suite 160  
Addison, TX 75001  
Tel: 972-818-7423 Fax: 972-818-2924

#### Dayton

Two Prestige Place, Suite 130  
Miamisburg, OH 45342  
Tel: 937-291-1654 Fax: 937-291-9175

#### Detroit

Tri-Atria Office Building  
32255 Northwestern Highway, Suite 190  
Farmington Hills, MI 48334  
Tel: 248-538-2250 Fax: 248-538-2260

#### Los Angeles

18201 Von Karman, Suite 1090  
Irvine, CA 92612  
Tel: 949-263-1888 Fax: 949-263-1338

#### New York

150 Motor Parkway, Suite 202  
Hauppauge, NY 11788  
Tel: 631-273-5305 Fax: 631-273-5335

#### San Jose

Microchip Technology Inc.  
2107 North First Street, Suite 590  
San Jose, CA 95131  
Tel: 408-436-7950 Fax: 408-436-7955

#### Toronto

6285 Northam Drive, Suite 108  
Mississauga, Ontario L4V 1X5, Canada  
Tel: 905-673-0699 Fax: 905-673-6509

### ASIA/PACIFIC

#### Australia

Microchip Technology Australia Pty Ltd  
Suite 22, 41 Rawson Street  
Epping 2121, NSW  
Australia  
Tel: 61-2-9868-6733 Fax: 61-2-9868-6755

#### China - Beijing

Microchip Technology Consulting (Shanghai)  
Co., Ltd., Beijing Liaison Office  
Unit 915  
New China Hong Kong Manhattan Bldg.  
No. 6 Chaoyangmen Beidajie  
Beijing, 100027, No. China  
Tel: 86-10-85282100 Fax: 86-10-85282104

#### China - Chengdu

Microchip Technology Consulting (Shanghai)  
Co., Ltd., Chengdu Liaison Office  
Rm. 2401, Ming Xing Financial Tower  
No. 88 TIDU Street  
Chengdu 610016, China  
Tel: 86-28-6766200 Fax: 86-28-6766599

#### China - Fuzhou

Microchip Technology Consulting (Shanghai)  
Co., Ltd., Fuzhou Liaison Office  
Rm. 531, North Building  
Fujian Foreign Trade Center Hotel  
73 Wusi Road  
Fuzhou 350001, China  
Tel: 86-591-7557563 Fax: 86-591-7557572

#### China - Shanghai

Microchip Technology Consulting (Shanghai)  
Co., Ltd.  
Room 701, Bldg. B  
Far East International Plaza  
No. 317 Xian Xia Road  
Shanghai, 200051  
Tel: 86-21-6275-5700 Fax: 86-21-6275-5060

#### China - Shenzhen

Microchip Technology Consulting (Shanghai)  
Co., Ltd., Shenzhen Liaison Office  
Rm. 1315, 13/F, Shenzhen Kerry Centre,  
Renminnan Lu  
Shenzhen 518001, China  
Tel: 86-755-2350361 Fax: 86-755-2366086

#### Hong Kong

Microchip Technology Hongkong Ltd.  
Unit 901, Tower 2, Metroplaza  
223 Hing Fong Road  
Kwai Fong, N.T., Hong Kong  
Tel: 852-2401-1200 Fax: 852-2401-3431

#### India

Microchip Technology Inc.  
India Liaison Office  
Divyasree Chambers  
1 Floor, Wing A (A3/A4)  
No. 11, O'Shaughnessey Road  
Bangalore, 560 025, India  
Tel: 91-80-2290061 Fax: 91-80-2290062

### Japan

Microchip Technology Japan K.K.  
Benex S-1 6F  
3-18-20, Shinyokohama  
Kohoku-Ku, Yokohama-shi  
Kanagawa, 222-0033, Japan  
Tel: 81-45-471-6166 Fax: 81-45-471-6122

### Korea

Microchip Technology Korea  
168-1, Youngbo Bldg. 3 Floor  
Samsung-Dong, Kangnam-Ku  
Seoul, Korea 135-882  
Tel: 82-2-554-7200 Fax: 82-2-558-5934

### Singapore

Microchip Technology Singapore Pte Ltd.  
200 Middle Road  
#07-02 Prime Centre  
Singapore, 188980  
Tel: 65-334-8870 Fax: 65-334-8850

### Taiwan

Microchip Technology Taiwan  
11F-3, No. 207  
Tung Hua North Road  
Taipei, 105, Taiwan  
Tel: 886-2-2717-7175 Fax: 886-2-2545-0139

### EUROPE

#### Denmark

Microchip Technology Denmark ApS  
Regus Business Centre  
Lautrup høj 1-3  
Ballerup DK-2750 Denmark  
Tel: 45 4420 9895 Fax: 45 4420 9910

#### France

Arizona Microchip Technology SARL  
Parc d'Activite du Moulin de Massy  
43 Rue du Saule Trapu  
Batiment A - 1er Etage  
91300 Massy, France  
Tel: 33-1-69-53-63-20 Fax: 33-1-69-30-90-79

#### Germany

Arizona Microchip Technology GmbH  
Gustav-Heinemann Ring 125  
D-81739 Munich, Germany  
Tel: 49-89-627-144-0 Fax: 49-89-627-144-44

#### Germany - Analog

Lochamer Strasse 13  
D-82152 Martinsried, Germany  
Tel: 49-89-895650-0 Fax: 49-89-895650-22

#### Italy

Arizona Microchip Technology SRL  
Centro Direzionale Colleoni  
Palazzo Taurus 1 V. Le Colleoni 1  
20041 Agrate Brianza  
Milan, Italy  
Tel: 39-039-65791-1 Fax: 39-039-6899883

#### United Kingdom

Arizona Microchip Technology Ltd.  
505 Eskdale Road  
Winnersh Triangle  
Wokingham  
Berkshire, England RG41 5TU  
Tel: 44 118 921 5869 Fax: 44-118 921-5820

06/01/01