

150mA, 10V LDO with Shutdown

Features

- Low Dropout Voltage: 200mV typ. at 80mA, 380mV typ. at 160mA
- High Output Current: 180mA ($V_{OUT} = 5.0V$)
- High Accuracy Output Voltage ($\pm 2\%$)
- Low Power Consumption: 11 μ A (Oper.), 0.1 μ A (Shutdown)
- Low Temperature Drift (± 100 ppm/ $^{\circ}$ C typ.)
- Excellent Line Regulation (0.2%/V typ.)
- Space Saving 5-Pin SOT-23A Package
- Short Circuit Protection
- Standard 2.5V, 3.0V and 3.3V Output Voltages

Applications

- Battery Powered Devices
- Cameras and Portable Video Equipment
- Pagers and Cellular Phones
- Solar Powered Instruments
- Consumer Products

Device Selection Table

Part Number	Output Voltage (V)*	Package	Temperature Range
TC562502ECT	2.5	5-Pin SOT-23A	-40 $^{\circ}$ C to +85 $^{\circ}$ C
TC563002ECT	3.0	5-Pin SOT-23A	-40 $^{\circ}$ C to +85 $^{\circ}$ C
TC563302ECT	3.3	5-Pin SOT-23A	-40 $^{\circ}$ C to +85 $^{\circ}$ C

*Other output voltages are available. Please contact Microchip Technology Inc. for details.

Package Type

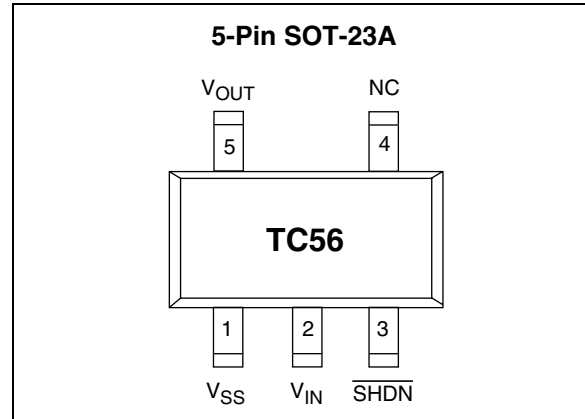

General Description

The TC56 is a low supply current (11 μ A typical at $V_{OUT} = 3V$), low dropout CMOS linear regulator, with a 10V maximum input voltage range. CMOS construction eliminates wasted ground current, typical of bipolar regulators, for greater system efficiencies and longer operating time in battery-powered systems. The TC56 enters shutdown mode when the shutdown control input (SHDN) is low. During shutdown, the regulator is shut off, and supply current falls to 0.1 μ A maximum. Normal operation is restored when SHDN is returned to a logic high. Low current consumption, 10V supply tolerance and space-saving 5-Pin SOT-23A packaging makes the TC56 ideal for a wide variety of applications.

Functional Block Diagram

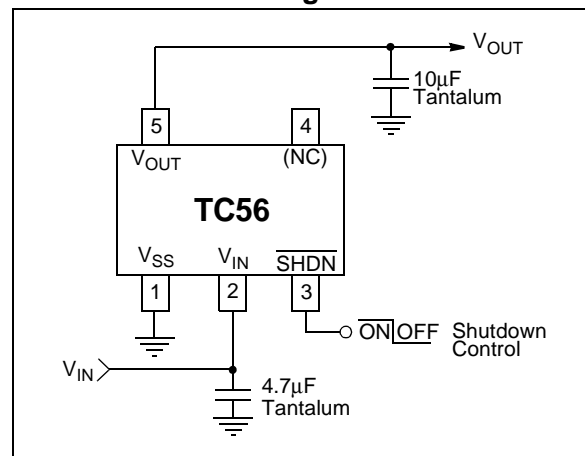

TC56

1.0 ELECTRICAL CHARACTERISTICS

Absolute Maximum Ratings*

Input Voltage	+12V
Output Current	500mA
Output Voltage.....	$V_{SS} - 0.3V$ to $V_{IN} + 0.3V$
SHDN Input Voltage	$V_{SS} - 0.3V$ to $V_{IN} + 0.3V$
Power Dissipation (SOT-23).....	150mW
Operating Temperature Range.....	-40°C to +85°C
Storage Temperature Range	-40°C to +125°C

*Stresses above those listed under "Absolute Maximum Ratings" may cause permanent damage to the device. These are stress ratings only and functional operation of the device at these or any other conditions above those indicated in the operation sections of the specifications is not implied. Exposure to Absolute Maximum Rating conditions for extended periods may affect device reliability.

TC56 ELECTRICAL SPECIFICATIONS

Electrical Characteristics: $V_{IN} = V_{OUT} + 1V$, $T_A = 25^\circ C$, $C_{IN} = 4.7\mu F$, $C_{OUT} = 10\mu F$, unless otherwise noted.						
Symbol	Parameter	Min	Typ	Max	Units	Test Conditions
V_{IN}	Input Voltage	—	—	10	V	
V_{OUT}	Output Voltage	$0.98 \times V_R$	$V_R \pm 0.5\%$	$1.02 \times V_R$	V	$I_{OUT} = 40mA$ (Note 1)
I_{OUTMAX}	Maximum Output Current	150 180	— —	— —	mA	$V_R \geq 2.7V$, $V_{OUT} = 3V$ (Note 1) $V_R \geq 4.5V$, $V_{OUT} = 5V$ (Note 1)
ΔV_{OUT}	Load Regulation	— —	45 40	90 80	mV	$1mA \leq I_{OUT} \leq 80mA$, $V_{OUT} = 3V$ $1mA \leq I_{OUT} \leq 80mA$, $V_{OUT} = 5V$
$V_{IN} - V_{OUT}$	Dropout Voltage	— — — —	200 380 165 330	395 770 330 660	mV	$I_{OUT} = 80mA$, $V_{OUT} = 3V$ $I_{OUT} = 160mA$, $V_{OUT} = 3V$ $I_{OUT} = 100mA$, $V_{OUT} = 5V$ $I_{OUT} = 200mA$, $V_{OUT} = 5V$ (Note 2)
I_{DD}	Supply Current	— —	11 13	19 21	μA	$\overline{V_{SHDN}} = V_{IN} = 4V$ $\overline{V_{SHDN}} = V_{IN} = 6V$
I_{SHDN}	Shutdown Supply Current	—	—	0.1	μA	$\overline{V_{SHDN}} = GND$
$\Delta V_{OUT}/\Delta V_{IN}$	Line Regulation	—	0.2	0.3	%/V	$I_{OUT} = 40mA$, $4V \leq V_{IN} \leq 10V$
$\Delta V_{OUT}/\Delta T$	V_{OUT} Temperature Coefficient	—	± 100	—	ppm/ $^\circ C$	$I_{OUT} = 10mA$, $-40^\circ C < T_J < +85^\circ C$
V_{IH}	SHDN Input High Logic Threshold	1.5	—	—	V	
V_{IL}	SHDN Input Low Logic Threshold	—	—	0.25	V	
I_{IH}	SHDN Input Current @ V_{IH}	—	—	5.0	μA	$\overline{V_{SHDN}} = V_{IN}$
I_{IL}	SHDN Input Current @ V_{IL}	-0.2	-0.05	0	μA	$\overline{V_{SHDN}} = GND$

Note 1: V_R is the regulator output voltage setting.

2: Dropout voltage is defined as the input to output differential at which the output voltage drops 2% below its nominal value measured at a 1V differential.

2.0 PIN DESCRIPTIONS

The descriptions of the pins are listed in Table 2-1.

TABLE 2-1: PIN FUNCTION TABLE

Pin No. (5-Pin SOT-23A)	Symbol	Description
1	V_{SS}	Ground.
2	V_{IN}	Supply voltage input.
3	\overline{SHDN}	Shutdown input.
4	(NC)	No connection.
5	V_{OUT}	Regulated voltage output.

3.0 DETAILED DESCRIPTION

The TC56 is a precision, fixed output LDO. Unlike bipolar regulations, the TC56 supply current does not increase with load current.

3.1 Output Capacitor

A 10 μ F tantalum capacitor from V_{OUT} to ground is recommended. The output capacitor should have an effective series resistance greater than 0.1 Ω and less than 5.0 Ω , and a resonant frequency above 1MHz. It is recommended that a 4.7 μ F capacitor be connected from V_{IN} to GND. When operating from sources other than batteries, supply noise rejection and transient response can be improved by increasing the value of the input and output capacitors and employing passive filtering techniques.

3.2 Shutdown Input

The TC56 enters a low power shutdown mode when the shutdown control input (\overline{SHDN}) is low. During shutdown, the regulator is disabled and supply current is reduced to 0.1 μ A (max). Normal operation is restored when \overline{SHDN} is driven high. If not required, the \overline{SHDN} input can be tied to V_{IN} .

4.0 THERMAL CONSIDERATIONS

4.1 Power Dissipation

The amount of power the regulator dissipates is primarily a function of input and output voltage, and output current. The following equation is used to calculate worst case actual power dissipation.

EQUATION 4-1:

$$P_D \approx (V_{INMAX} - V_{OUTMIN})I_{LOADMAX}$$

Where:

P_D = Worst case actual power dissipation
 V_{INMAX} = Maximum voltage on V_{IN}
 V_{OUTMIN} = Minimum regulator output voltage
 $I_{LOADMAX}$ = Maximum output (load) current

The maximum allowable power dissipation (Equation 4-2) is a function of the maximum ambient temperature (T_{AMAX}), the maximum allowable die temperature (T_{JMAX}) and the thermal resistance from junction-to-air (θ_{JA}). The 5-Pin SOT-23A package has a θ_{JA} of approximately 220°C/Watt.

EQUATION 4-2:

$$P_{DMAX} = \frac{(T_{JMAX} - T_{AMAX})}{\theta_{JA}}$$

Where all terms are previously defined.

Equation 4-1 can be used in conjunction with Equation 4-2 to ensure regulator thermal operation is within limits. For example:

Given:

$$V_{INMAX} = 3.0V \pm 10\%$$

$$V_{OUTMIN} = 2.7V - 2\%$$

$$I_{LOADMAX} = 98mA$$

$$T_{JMAX} = 125^\circ C$$

$$T_{AMAX} = 55^\circ C$$

Find: 1. Actual power dissipation
 2. Maximum allowable dissipation

Actual power dissipation:

$$\begin{aligned} P_D &\approx (V_{INMAX} - V_{OUTMIN})I_{LOADMAX} \\ &= [(3.0 \times 1.1) - (2.7 \times .98)]98 \times 10^{-3} \\ &= 64mW \end{aligned}$$

Maximum allowable power dissipation:

$$\begin{aligned} P_{DMAX} &= \frac{(T_{JMAX} - T_{AMAX})}{\theta_{JA}} \\ &= \frac{(125 - 55)}{220} \\ &= 318mW \end{aligned}$$

In this example, the TC56 dissipates a maximum of 64mW; below the allowable limit of 318mW. In a similar manner, Equation 4-1 and Equation 4-2 can be used to calculate maximum current and/or input voltage limits.

4.2 Layout Considerations

The primary path of heat conduction out of the package is via the package leads. Therefore, layouts having a ground plane, wide traces at the pads, and wide power supply bus lines combine to lower θ_{JA} and therefore, increase the maximum allowable power dissipation limit.

5.0 TYPICAL CHARACTERISTICS

Note: The graphs and tables provided following this note are a statistical summary based on a limited number of samples and are provided for informational purposes only. The performance characteristics listed herein are not tested or guaranteed. In some graphs or tables, the data presented may be outside the specified operating range (e.g., outside specified power supply range) and therefore outside the warranted range.

1. OUTPUT VOLTAGE vs. OUTPUT CURRENT

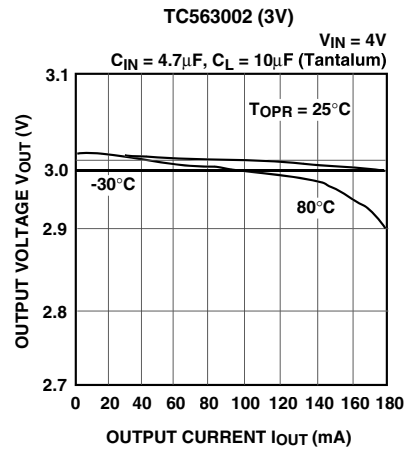
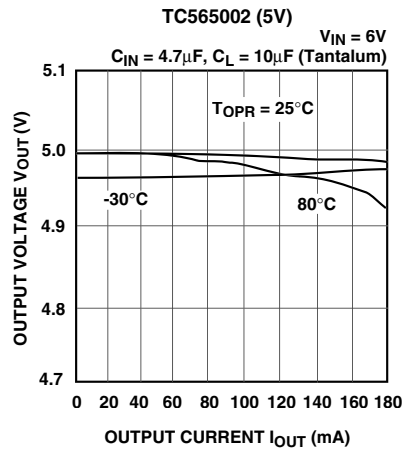

2. OUTPUT VOLTAGE vs. INPUT VOLTAGE

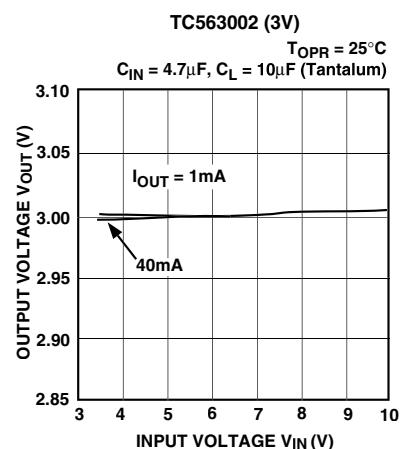
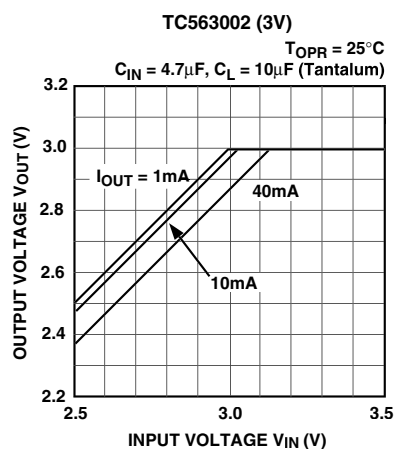
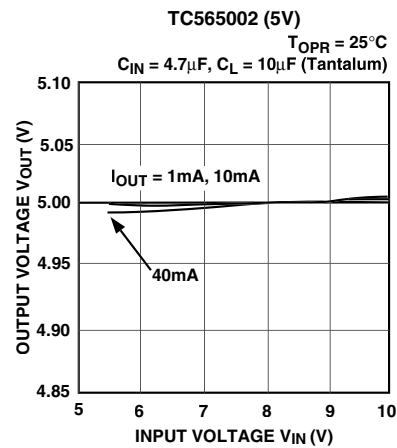
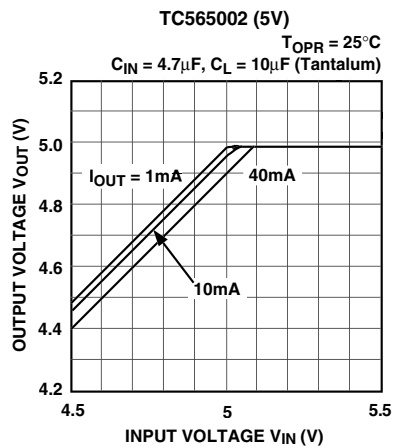

5.0 TYPICAL CHARACTERISTICS (CONTINUED)

3. INPUT/OUTPUT VOLTAGE DIFFERENTIAL vs. OUTPUT CURRENT

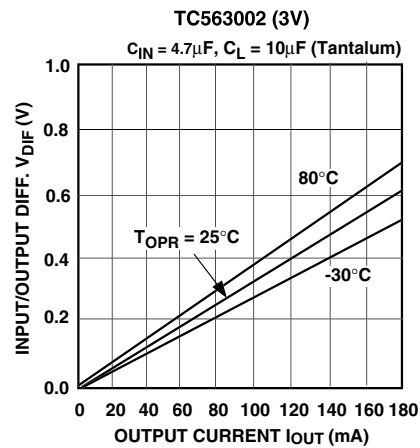
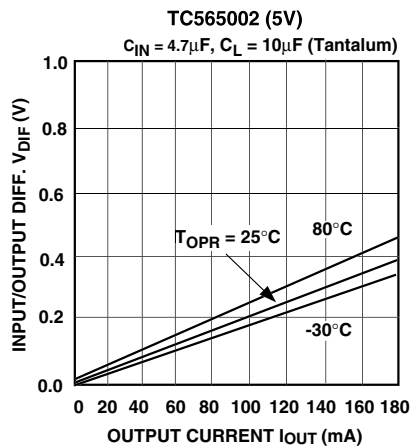

4. SHDN PIN THRESHOLD VOLTAGE vs. INPUT VOLTAGE

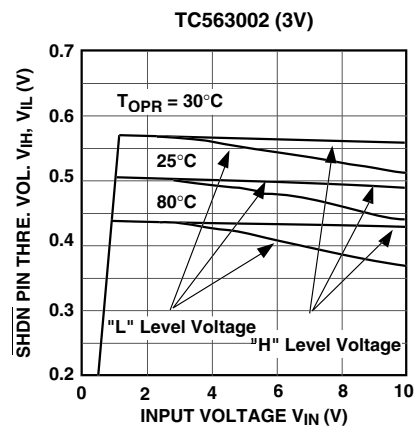
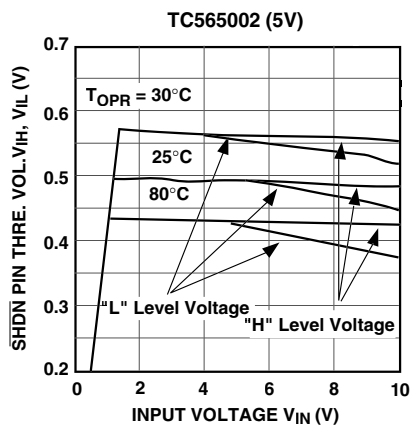

5. SUPPLY CURRENT vs. INPUT VOLTAGE

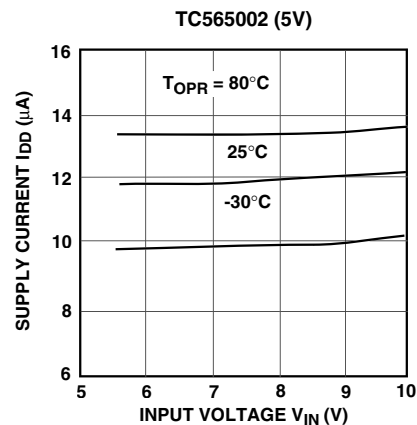
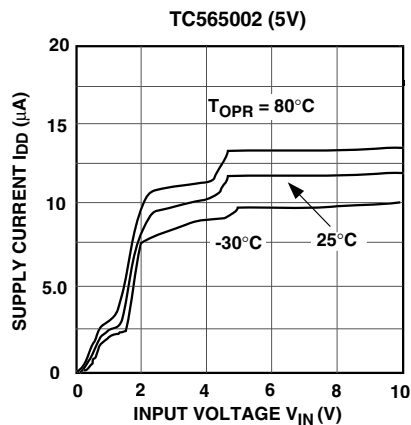

5.0 TYPICAL CHARACTERISTICS (CONTINUED)

5. SUPPLY CURRENT vs. INPUT VOLTAGE (CONT.)

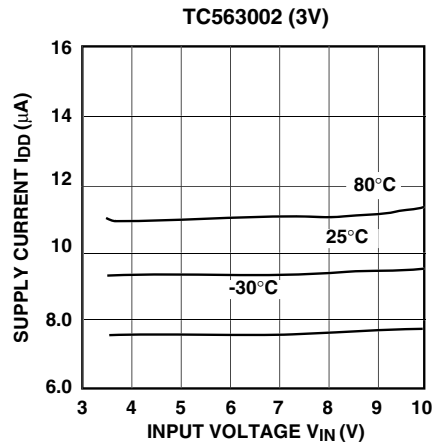
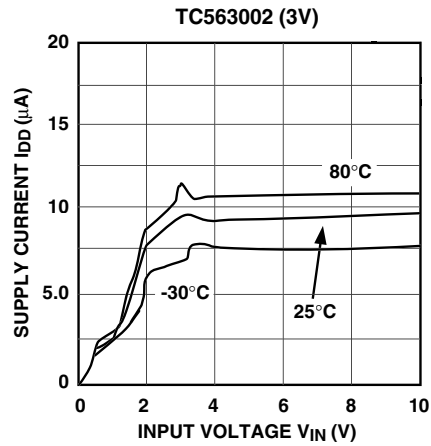

6. OUTPUT VOLTAGE vs. AMBIENT TEMPERATURE

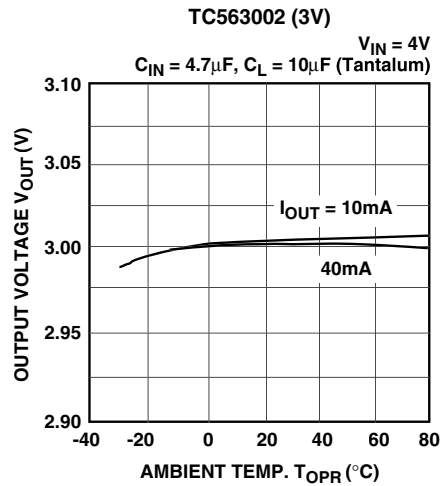
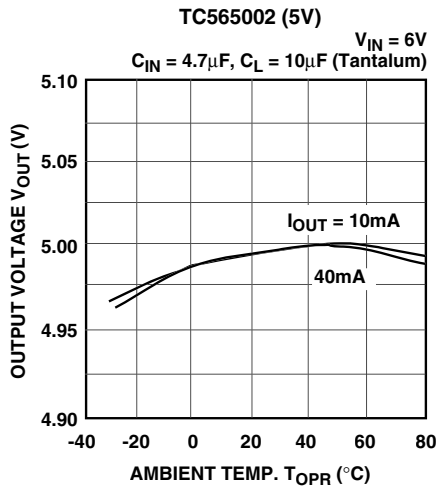

7. SUPPLY CURRENT vs. AMBIENT TEMPERATURE

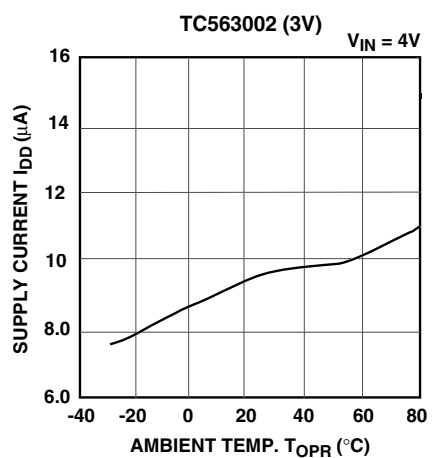
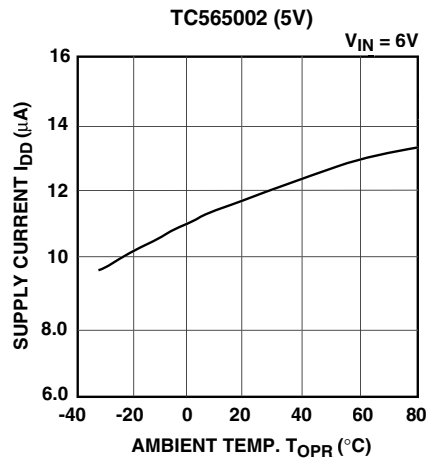

5.0 TYPICAL CHARACTERISTICS (CONTINUED)

8. INPUT TRANSIENT RESPONSE 1

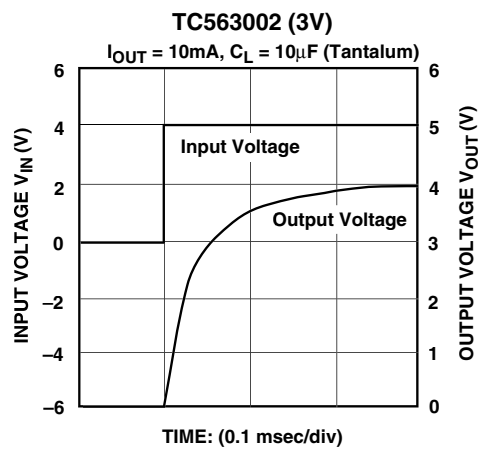
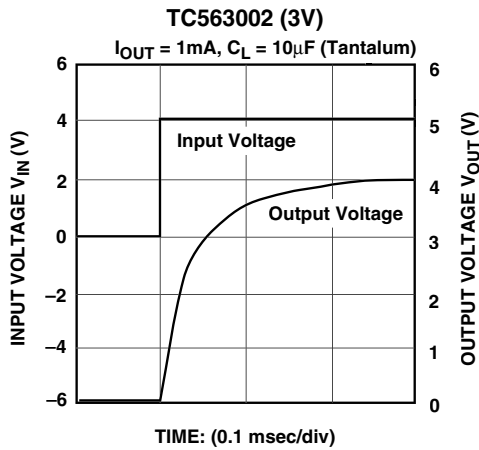
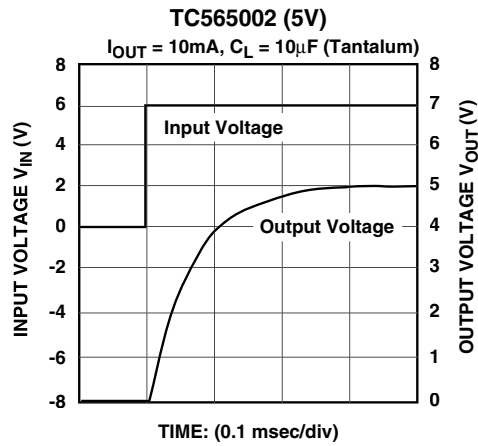
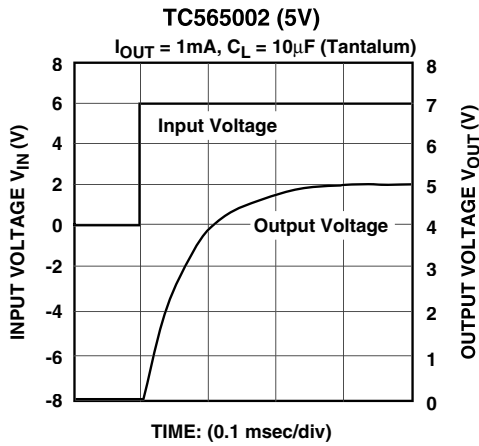

9. INPUT TRANSIENT RESPONSE 2

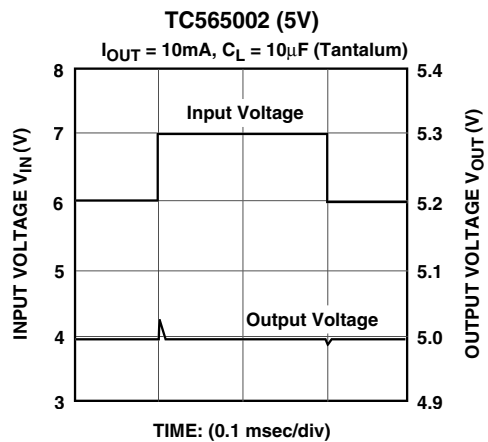
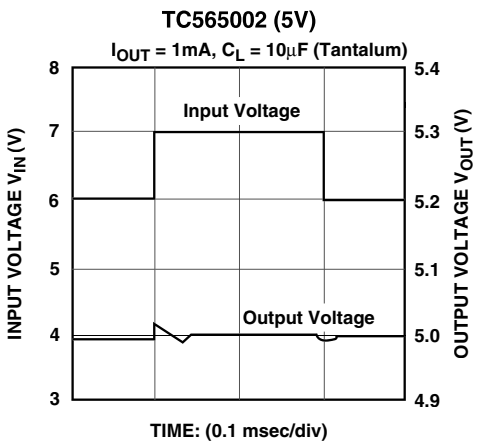

5.0 TYPICAL CHARACTERISTICS (CONTINUED)

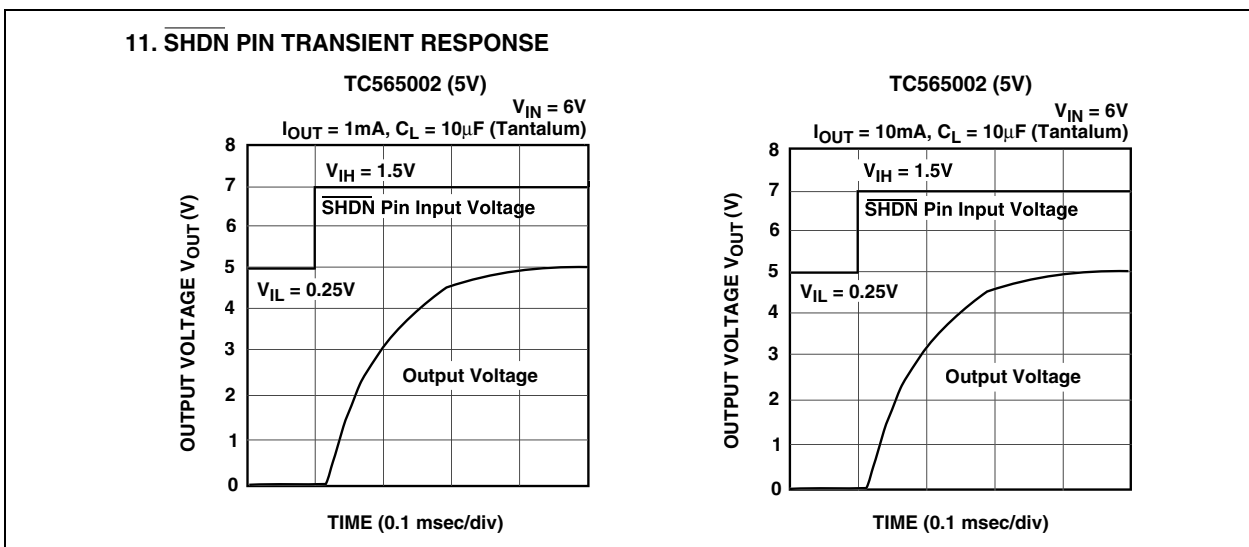
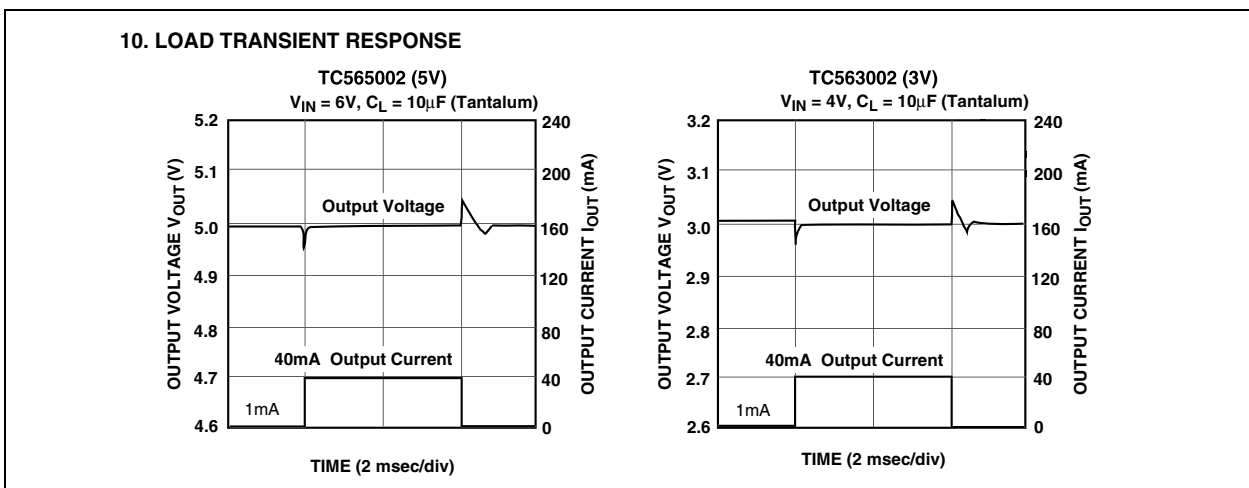
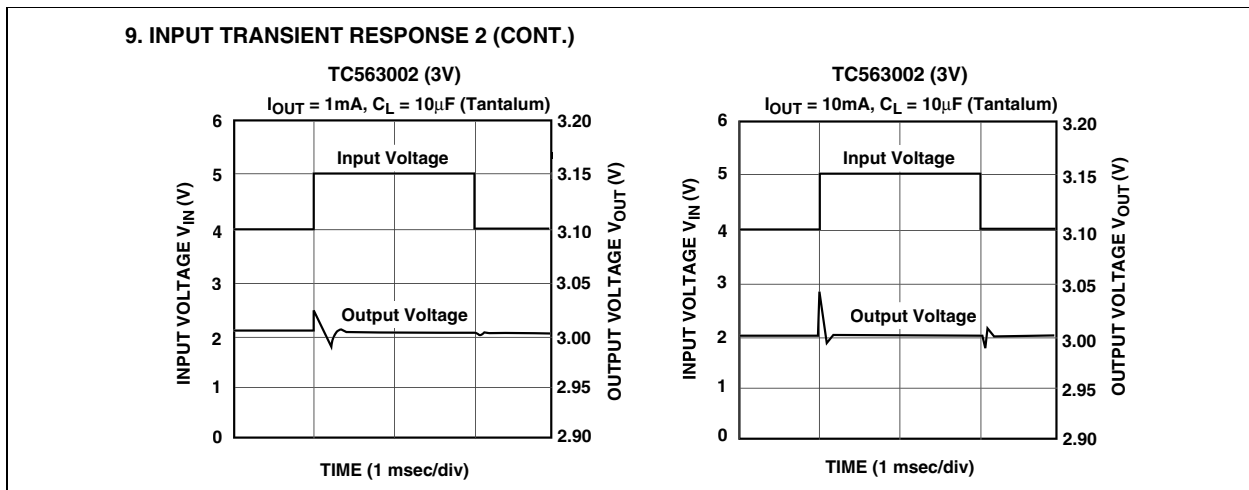

5.0 TYPICAL CHARACTERISTICS (CONTINUED)

11. SHDN PIN TRANSIENT RESPONSE (CONT.)

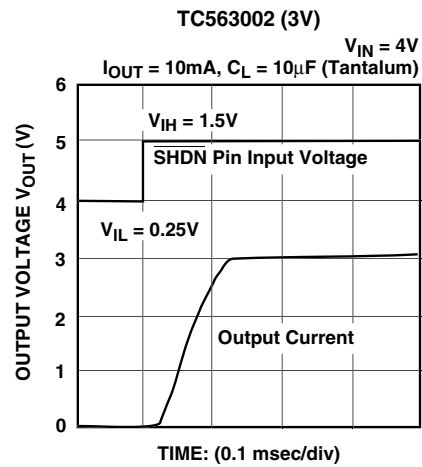
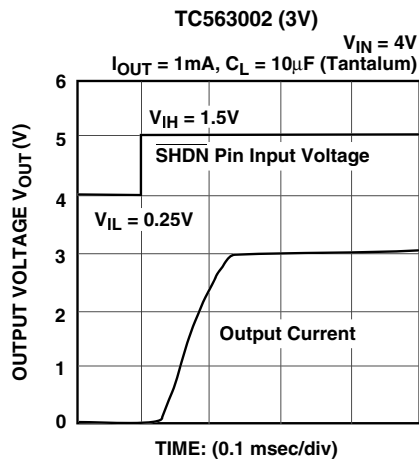

12. RIPPLE REJECTION RATE

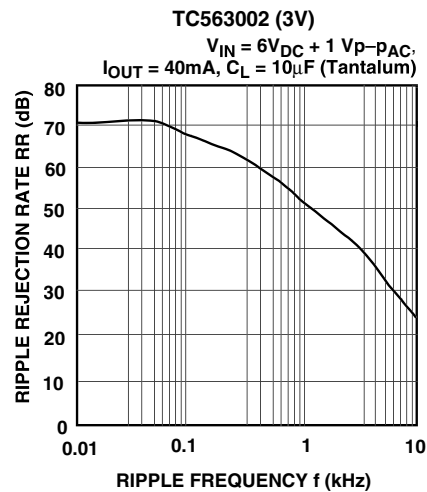
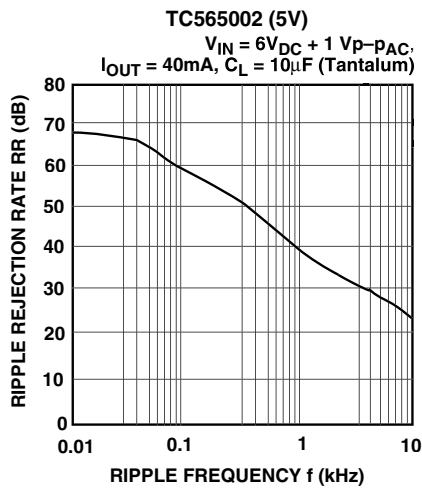

6.0 PACKAGING INFORMATION

6.1 Package Marking Information

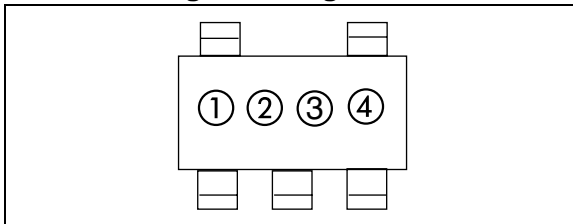

① represents the integer of the output voltage

Symbol	Voltage
A	0.
B	1.
C	2.
D	3.
E	4.
F	5.
H	6.

② represents the integer of the output voltage

Symbol	Voltage	Symbol	Voltage
A	.0	F	.5
B	.1	H	.6
C	.2	K	.7
D	.3	L	.8
E	.4	M	.9

③ represents the transition response

Symbol	
—	REGULAR

④ represents assembly lot code

6.2 Taping Form

Component Taping Orientation for 5-Pin SOT-23A (EIAJ SC-74A) Devices

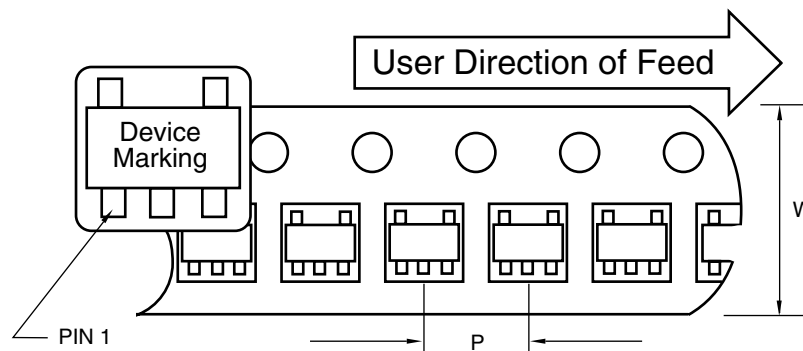

Standard Reel Component Orientation
TR Suffix Device
(Mark Right Side Up)

Carrier Tape, Number of Components Per Reel and Reel Size

Package	Carrier Width (W)	Pitch (P)	Part Per Full Reel	Reel Size
5-Pin SOT-23A	8 mm	4 mm	3000	7 in

Sales and Support

Data Sheets

Products supported by a preliminary Data Sheet may have an errata sheet describing minor operational differences and recommended workarounds. To determine if an errata sheet exists for a particular device, please contact one of the following:

1. Your local Microchip sales office
2. The Microchip Corporate Literature Center U.S. FAX: (480) 792-7277
3. The Microchip Worldwide Site (www.microchip.com)

Please specify which device, revision of silicon and Data Sheet (include Literature #) you are using.

New Customer Notification System

Register on our web site (www.microchip.com/cn) to receive the most current information on our products.

TC56

NOTES:

Information contained in this publication regarding device applications and the like is intended through suggestion only and may be superseded by updates. It is your responsibility to ensure that your application meets with your specifications. No representation or warranty is given and no liability is assumed by Microchip Technology Incorporated with respect to the accuracy or use of such information, or infringement of patents or other intellectual property rights arising from such use or otherwise. Use of Microchip's products as critical components in life support systems is not authorized except with express written approval by Microchip. No licenses are conveyed, implicitly or otherwise, under any intellectual property rights.

Trademarks

The Microchip name and logo, the Microchip logo, FilterLab, KEELOQ, microID, MPLAB, PIC, PICmicro, PICMASTER, PICSTART, PRO MATE, SEEVAL and The Embedded Control Solutions Company are registered trademarks of Microchip Technology Incorporated in the U.S.A. and other countries.

dsPIC, ECONOMONITOR, FanSense, FlexROM, fuzzyLAB, In-Circuit Serial Programming, ICSP, ICEPIC, microPort, Migratable Memory, MPASM, MPLIB, MPLINK, MPSIM, MXDEV, MXLAB, PICC, PICDEM, PICDEM.net, rPIC, Select Mode and Total Endurance are trademarks of Microchip Technology Incorporated in the U.S.A.

Serialized Quick Turn Programming (SQTP) is a service mark of Microchip Technology Incorporated in the U.S.A.

All other trademarks mentioned herein are property of their respective companies.

© 2002, Microchip Technology Incorporated, Printed in the U.S.A., All Rights Reserved.

 Printed on recycled paper.

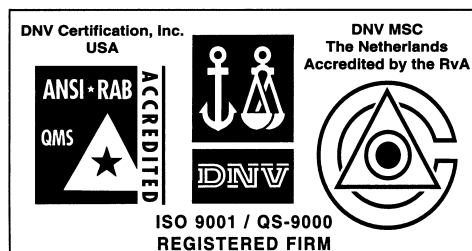

Microchip received QS-9000 quality system certification for its worldwide headquarters, design and wafer fabrication facilities in Chandler and Tempe, Arizona in July 1999 and Mountain View, California in March 2002. The Company's quality system processes and procedures are QS-9000 compliant for its PICmicro® 8-bit MCUs, KEELOQ® code hopping devices, Serial EEPROMs, microperipherals, non-volatile memory and analog products. In addition, Microchip's quality system for the design and manufacture of development systems is ISO 9001 certified.



WORLDWIDE SALES AND SERVICE

AMERICAS

Corporate Office

2355 West Chandler Blvd.
Chandler, AZ 85224-6199
Tel: 480-792-7200 Fax: 480-792-7277
Technical Support: 480-792-7627
Web Address: <http://www.microchip.com>

Rocky Mountain

2355 West Chandler Blvd.
Chandler, AZ 85224-6199
Tel: 480-692-7966 Fax: 480-792-7456

Atlanta

500 Sugar Mill Road, Suite 200B
Atlanta, GA 30350
Tel: 770-640-0034 Fax: 770-640-0307

Boston

2 Lan Drive, Suite 120
Westford, MA 01886
Tel: 978-692-3848 Fax: 978-692-3821

Chicago

333 Pierce Road, Suite 180
Itasca, IL 60143
Tel: 630-285-0071 Fax: 630-285-0075

Dallas

4570 Westgrove Drive, Suite 160
Addison, TX 75001
Tel: 972-818-7423 Fax: 972-818-2924

Detroit

Tri-Atria Office Building
32255 Northwestern Highway, Suite 190
Farmington Hills, MI 48334
Tel: 248-538-2250 Fax: 248-538-2260

Kokomo

2767 S. Albright Road
Kokomo, Indiana 46902
Tel: 765-864-8360 Fax: 765-864-8387

Los Angeles

18201 Von Karman, Suite 1090
Irvine, CA 92612
Tel: 949-263-1888 Fax: 949-263-1338

New York

150 Motor Parkway, Suite 202
Hauppauge, NY 11788
Tel: 631-273-5305 Fax: 631-273-5335

San Jose

Microchip Technology Inc.
2107 North First Street, Suite 590
San Jose, CA 95131
Tel: 408-436-7950 Fax: 408-436-7955

Toronto

6285 Northam Drive, Suite 108
Mississauga, Ontario L4V 1X5, Canada
Tel: 905-673-0699 Fax: 905-673-6509

ASIA/PACIFIC

Australia

Microchip Technology Australia Pty Ltd
Suite 22, 41 Rawson Street
Epping 2121, NSW
Australia
Tel: 61-2-9868-6733 Fax: 61-2-9868-6755

China - Beijing

Microchip Technology Consulting (Shanghai)
Co., Ltd., Beijing Liaison Office
Unit 915
Bei Hai Wan Tai Bldg.
No. 6 Chaoyangmen Beidajie
Beijing, 100027, No. China
Tel: 86-10-85282100 Fax: 86-10-85282104

China - Chengdu

Microchip Technology Consulting (Shanghai)
Co., Ltd., Chengdu Liaison Office
Rm. 2401, 24th Floor,
Ming Xing Financial Tower
No. 88 TIDU Street
Chengdu 610016, China
Tel: 86-28-86766200 Fax: 86-28-86766599

China - Fuzhou

Microchip Technology Consulting (Shanghai)
Co., Ltd., Fuzhou Liaison Office
Unit 28F, World Trade Plaza
No. 71 Wusi Road
Fuzhou 350001, China
Tel: 86-591-7503506 Fax: 86-591-7503521

China - Shanghai

Microchip Technology Consulting (Shanghai)
Co., Ltd.
Room 701, Bldg. B
Far East International Plaza
No. 317 Xian Xia Road
Shanghai, 200051
Tel: 86-21-6275-5700 Fax: 86-21-6275-5060

China - Shenzhen

Microchip Technology Consulting (Shanghai)
Co., Ltd., Shenzhen Liaison Office
Rm. 1315, 13/F, Shenzhen Kerry Centre,
Renminnan Lu
Shenzhen 518001, China
Tel: 86-755-2350361 Fax: 86-755-2366086

China - Hong Kong SAR

Microchip Technology Hongkong Ltd.
Unit 901-6, Tower 2, Metroplaza
223 Hing Fong Road
Kwai Fong, N.T., Hong Kong
Tel: 852-2401-1200 Fax: 852-2401-3431

India

Microchip Technology Inc.
India Liaison Office
Divyasree Chambers
1 Floor, Wing A (A3/A4)
No. 11, O'Shaugnessey Road
Bangalore, 560 025, India
Tel: 91-80-2290061 Fax: 91-80-2290062

Japan

Microchip Technology Japan K.K.
Benex S-1 6F
3-18-20, Shinyokohama
Kohoku-Ku, Yokohama-shi
Kanagawa, 222-0033, Japan
Tel: 81-45-471- 6166 Fax: 81-45-471-6122

Korea

Microchip Technology Korea
168-1, Youngbo Bldg. 3 Floor
Samsung-Dong, Kangnam-Ku
Seoul, Korea 135-882
Tel: 82-2-554-7200 Fax: 82-2-558-5934

Singapore

Microchip Technology Singapore Pte Ltd.
200 Middle Road
#07-02 Prime Centre
Singapore, 188980
Tel: 65-6334-8870 Fax: 65-6334-8850

Taiwan

Microchip Technology Taiwan
11F-3, No. 207
Tung Hua North Road
Taipei, 105, Taiwan
Tel: 886-2-2717-7175 Fax: 886-2-2545-0139

EUROPE

Denmark

Microchip Technology Nordic ApS
Regus Business Centre
Lautrup høj 1-3
Ballerup DK-2750 Denmark
Tel: 45 4420 9895 Fax: 45 4420 9910

France

Microchip Technology SARL
Parc d'Activite du Moulin de Massy
43 Rue du Saule Trapu
Batiment A - 1er Etage
91300 Massy, France
Tel: 33-1-69-53-63-20 Fax: 33-1-69-30-90-79

Germany

Microchip Technology GmbH
Gustav-Heinemann Ring 125
D-81739 Munich, Germany
Tel: 49-89-627-144 0 Fax: 49-89-627-144-44

Italy

Microchip Technology SRL
Centro Direzionale Colleoni
Palazzo Taurus 1 V. Le Colleoni 1
20041 Agrate Brianza
Milan, Italy
Tel: 39-039-65791-1 Fax: 39-039-6899883

United Kingdom

Microchip Ltd.
505 Eskdale Road
Winnersh Triangle
Wokingham
Berkshire, England RG41 5TU
Tel: 44 118 921 5869 Fax: 44-118 921-5820

05/01/02

