

MICRO

ELECTRON

HIGH EFFICIENCY
RED/GREEN
DUAL COLOR LAMP

DESCRIPTION

A red and green lamp made of GaAlAs, GaP offering a changing color characteristics dependent on the direction the lamp is biased. These two light emitting diodes are mounted in a 5mm diameter dual color lens.

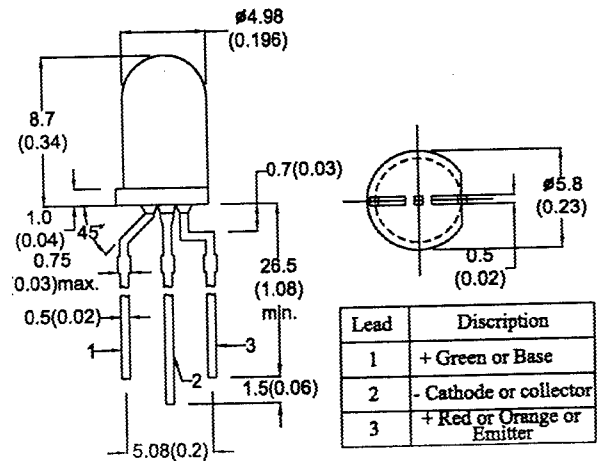

- All dimension in mm(inch)
- No Scale
- Tol. : +/-0.3mm

ABSOLUTE MAXIMUM RATINGS

Power Dissipation @ Ta=25°C
Forward Current, DC (IF)
Reverse Voltage
Operating & Storage Temperature Range
Lead Temperature

	RED	GREEN
Power Dissipation	100mW	100mW
Forward Current, DC (IF)	40mA	30mA
Reverse Voltage	5V	5V
Operating & Storage Temperature Range	-55 to +100°C	
Lead Temperature	260°C	

ELECTRO-OPTICAL CHARACTERISTICS (Ta=25°C)

PARAMETER	SYMBOL	RED	GREEN	UNIT	CONDITIONS
Forward Voltage	MAX VF	3.0	3.0	V	IF=20mA
Reverse Breakdown Voltage	MIN BVR	5	5	V	IR=100μA
Luminous Intensity	MIN IV	200	130	mcd	IF=20mA
	TYP	300	200	mcd	IF=20mA
Peak Wavelength	TYP λp	660	570	nm	IF=20mA
Spectral Line Half Width	TYP Δλ	20	30	nm	IF=20mA



MICRO ELECTRONICS LTD.

38, Hung To Road, Microtron Bulding, Kwun Tong, Kowloon, Hong Kong.

Kwun Tong P.O. Box 69477 Hong Kong. Fax No. 2341 0321 Telex:43510 Micro Hx. Tel: 2343 0181-5

MSCB51TAP(GREEN)

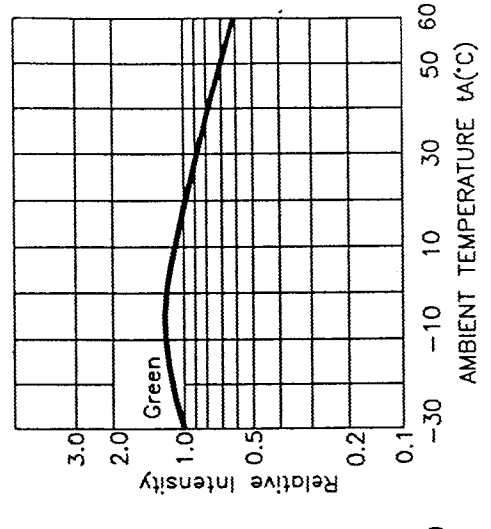
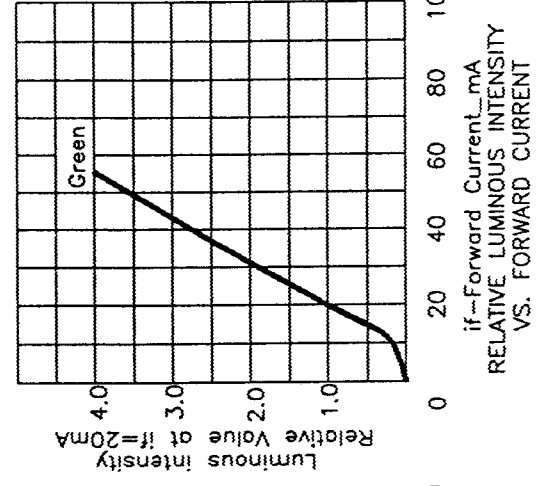
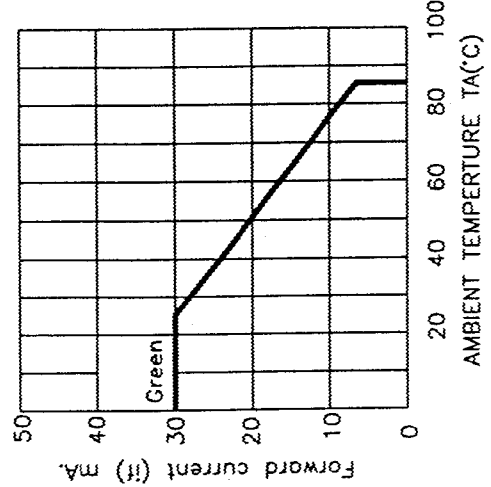
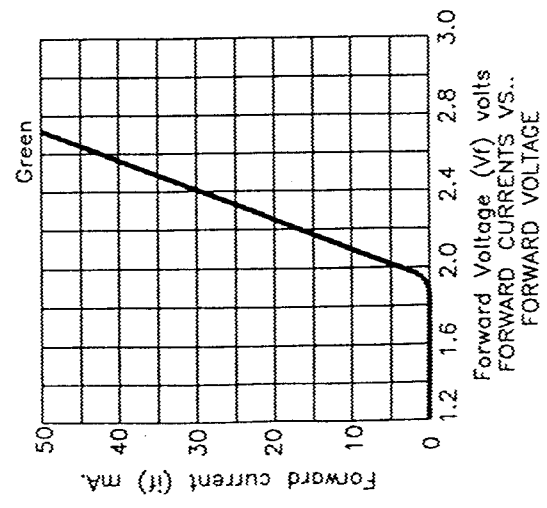
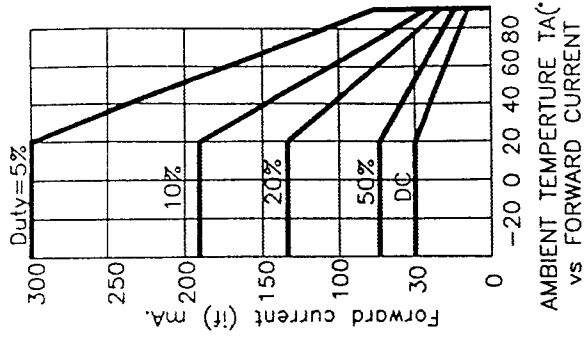
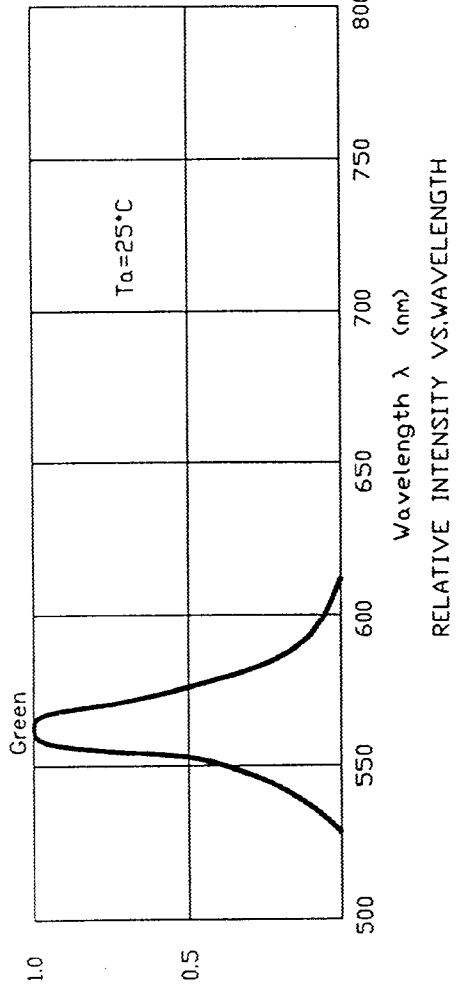
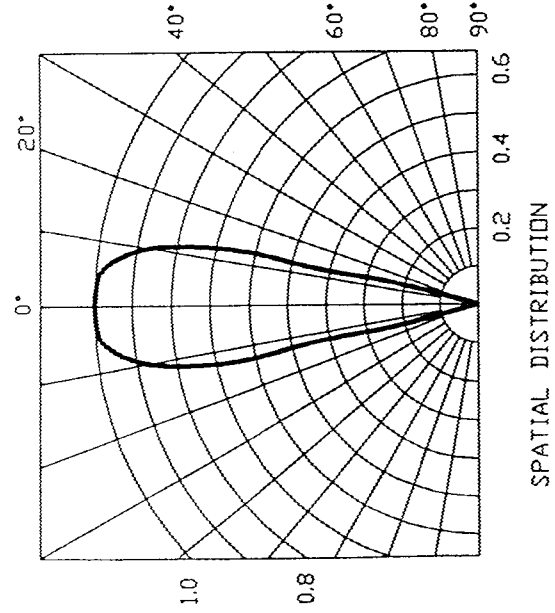

MSGB51TAP(RED)

