

Features and Benefits

- Small package (SOT-89)
- Low dropout voltage (typical 30mV)
- Large temperature range
- Overtoltage protection
- Reverse polarity protection
- Low supply current

Applications

- Sensor Overtoltage Protection
- Sensor Reverse Polarity Protection

Ordering Information

Part No.	Temperature Suffix	Package	Option	Temperature Range
MLX12101	E	SA	N/A	-40C to 85C Extended

Functional Diagram

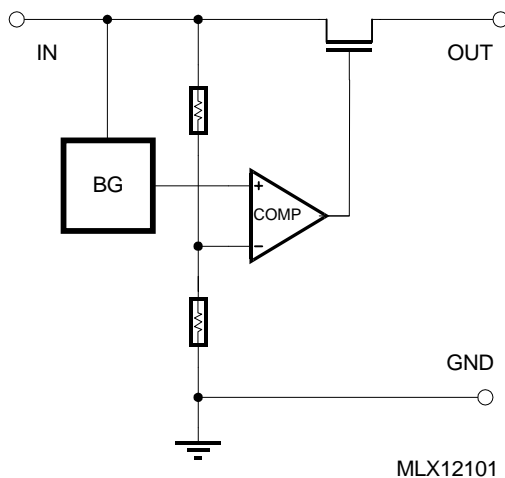

Description

The MLX12101 serves as a protection circuit where sensible 5V IC's are supplied by long wires that can be short-circuited to the wiring harness of a car.

The IC is to be connected between a 5V supply, and a 5V powered remote application. The IC is set on the remote application side, its input receiving the 5V supply through the car wiring, and its output delivering the 5V protected supply to the local application.

When the input is below 5.5 Volt, the switch between 5V input and 5V output is closed and the application is powered. When the 5V input goes above 6.8 Volt (This case occurs when the supply wire is short-circuited to battery plus), the output is shut off. When the chip input goes negative (this is the case when the battery is reversed), a reverse polarity diode prevents the output of going negative.

MLX12101 Electrical Specifications

DC Operating Parameters $T_A = -40^{\circ}\text{C}$ to 135°C , $V_{DD} = 5\text{V}$ (unless otherwise specified)

Parameter	Symbol	Test Condition	Min	Typ	Max	Unit
Recommended Operating Conditions						
Input Voltage			4.5	5.0	5.5	V
Output Current				8		mA
Output Signal Specifications						
Switch-Off Time ($V_{out} < 5\text{V}$)		V_{in} jump from 5V to 12V		150	1000	μs
Reverse Current		Through V_{out} with V_{DD} and V_{SS} connected			5	mA
Reverse Output Voltage					$V_{SS}-1$	V
Voltage drop-out, $V_{out}-V_{in}$		$V_{in} = 4.5\text{V}$ $I_{out} = 8\text{mA}$			55	mV
General Specifications						
Overall Supply Current		No Load			500	μA
		$V_{in} = 5\text{V}$ $R_{load} \text{ Pin} = 22\text{R}$		190		mA
Switching Voltage	V_t		5.5		6.8	V

MLX12101 Absolute Maximum Ratings

Parameter	Value	Unit	Comment
Max Operating Voltage Range	-14 to 16	V	
Max Output Current	100	mA	
Supply Current	0.5	mA	
Operating temperature	-40 to 150	$^{\circ}\text{C}$	
Max junction temperature	150	$^{\circ}\text{C}$	

SUPPLY CURRENT CHARACTERISTIC

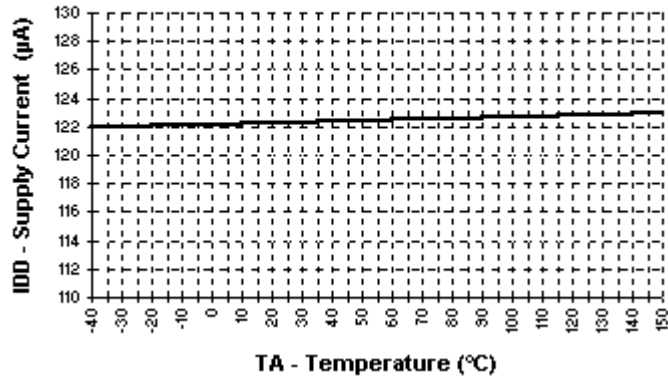

Figure 2

VOLTAGE DROP CHARACTERISTIC
with supply current = 50 mA

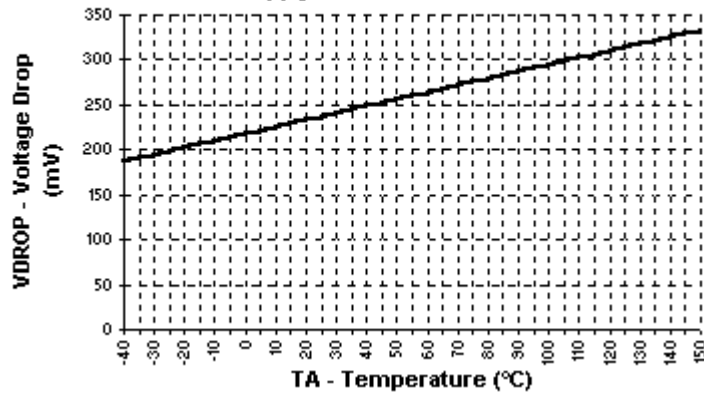

Figure 3

OUTPUT SHUT OFF VOLTAGE CHARACTERISTIC

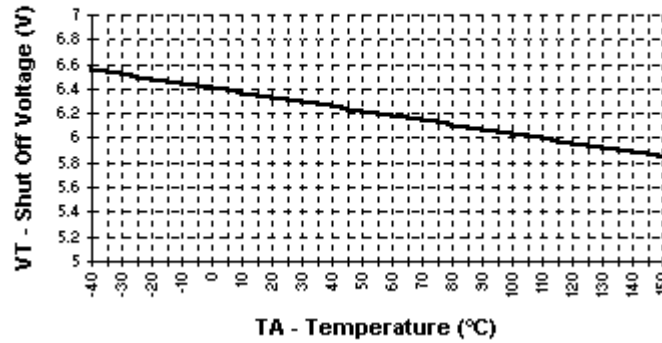
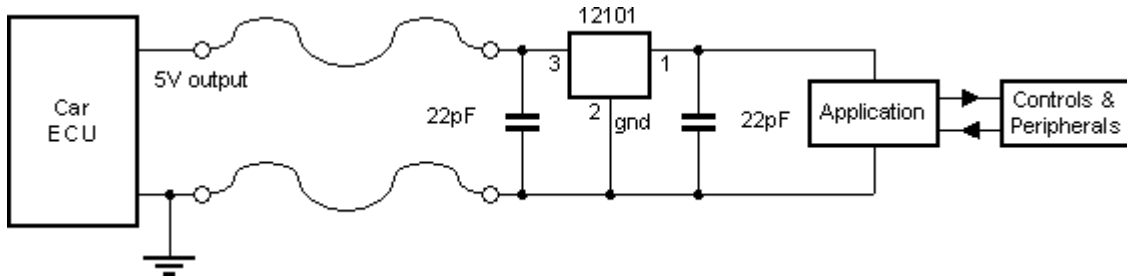

Figure 4

Typical Circuit Diagram

The 12101 is designed for EMC protection in automotive applications.

Figure 5



MLX12101 Overshoot Switch-off Timing

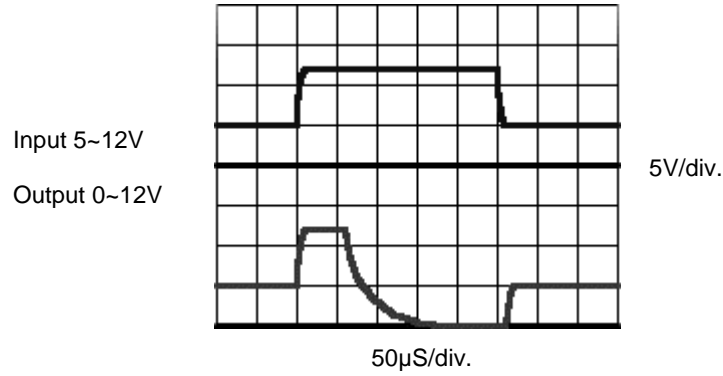

MLX12101 Pinout - SA (SOT-89A) Package

Pin number	Description
1	5V output
2	Ground
3	5V input

SOT-89 rear view

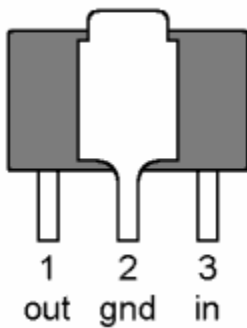

SOT-89A - Rear View

Melexis Worldwide Locations

For the latest version of this document,
Go to our website at:

www.melexis.com

*For additional information
contact Melexis Direct:*

USA

Melexis Inc.
41 Locke Road, Concord, NH 03301
Phone: +1 603 223 2362 Fax: +1 603 223 9614
E-mail: sales_usa@melexis.com

France

Melexis France
Tour Arago, 5 rue Bellini, 92806 Puteaux-La-Défense, France.
Phone: +33 1 47 78 11 34 Fax: +33 1 47 78 06 35
E-mail: sales_france@melexis.com

Germany

Melexis GmbH
Schiess-strasse 55, 40549 Düsseldorf, Germany
Phone: +49 211 5360212 Fax: +49 211 5360250
E-mail: sales_de@melexis.com

Or contact one of our qualified representatives :

United Kingdom

Silicon Concepts
PCB Lynchborough Road, Hampshire GU30 7SB, United Kingdom
Phone: +44 1428 751 617 Fax: +44 1428 751 603
E-mail: sales_uk@melexis.com

Italy

Dimacred IRL
Via Papa Giovanni XXIII no. 25, 20046 Biassono, Italy
Phone: +39 039 249 4856 Fax: +39 039 491773
E-mail: sales_italy@melexis.com

Japan

Star Electronics Co. Ltd.
1-14-10 Shiba Minato-Ku, Tokyo, Japan
Phone + 81 3 3452 7171 Fax + 81 3 3769 2197
E-mail: sales_japan@melexis.com

Taiwan

Beechwood Int'l Taiwan Co.
Room 8, 17F, No. 189, Taipei, Taiwan
Phone: +886 2 2739 3322 Fax: +886 2 2739 3090
E-mail: sales_taiwan@melexis.com

Korea

NeoS Korea
Rm205 chungho plaza, 668-9, deungchon-dong, kangse-ku, seoul 157-030
Korea
Phone + 82-2-3665-6527 Fax + 82-3665-6529
E-mail: sales_korea@melexis.com

Disclaimer

Melexis reserves the right to periodically make modifications to product specifications. The information included herein is believed to be accurate and reliable. However, Melexis assumes no responsibility for its use; nor for any infringements of patents or other rights of third parties which may result from its use.