



The Infinite Bandwidth Company™

MIC284

Two-Zone Thermal Supervisor

Advance Information

General Description

The MIC284 is a versatile digital thermal supervisor capable of measuring temperature using its own internal sensor and an inexpensive external sensor or embedded silicon diode such as those found in the Intel Pentium III* CPU. A 2-wire serial interface is provided to allow communication with either I²C** or SMBus* masters. Features include an open-drain over-temperature output with dedicated registers for implementing fan control or over-temperature shutdown circuits.

Interrupt status and mask bits are provided for reduced software overhead. The open-drain interrupt output pin can be used as either an overtemperature alarm or a thermostatic control signal. A programmable address pin permits two devices to share the bus. (Alternate base addresses available-contact Micrel.) Superior performance, low power and small size makes the MIC284 an excellent choice for the most demanding thermal management applications.

*SMBus and Pentium III are trademarks of Intel Corporation.

**I²C is a trademark of Philips Electronics, N.V.

Features

- Optimized for CPU Thermal Supervision in Computing Applications
- Measures Local and Remote Temperature
- Sigma-Delta ADC for 8-Bit Temperature Results
- 2-Wire SMBus-compatible Interface
- Programmable Thermostat Settings for both Internal and External Zones
- Open-Drain Interrupt Output Pin
- Open-Drain Over Temperature Output Pin for Fan Control or Hardware Shutdown
- Interrupt Mask and Status Bits
- Low Power Shutdown Mode
- Failsafe response to diode faults
- 2.7V to 5.5V Power Supply Range
- 8-Lead SOIC and MSOP Packages

Applications

- Desktop, Server and Notebook Computers
- Power Supplies
- Test and Measurement Equipment
- Wireless Systems
- Networking/Datacom Hardware

Ordering Information

Part Number	Base Address(*)	Junction Temp. Range	Package	Notes
MIC284-0BM	100 100x	-55°C to +125°C	8-Lead SOP	
MIC284-1BM	100 101x	-55°C to +125°C	8-Lead SOP	Contact Factory
MIC284-2BM	100 110x	-55°C to +125°C	8-Lead SOP	Contact Factory
MIC284-3BM	100 111x	-55°C to +125°C	8-Lead SOP	Contact Factory
MIC284-0BMM	100 100x	-55°C to +125°C	8-Lead MSOP	
MIC284-1BMM	100 101x	-55°C to +125°C	8-Lead MSOP	Contact Factory
MIC284-2BMM	100 110x	-55°C to +125°C	8-Lead MSOP	Contact Factory
MIC284-3BMM	100 111x	-55°C to +125°C	8-Lead MSOP	Contact Factory

* The least-significant bit of the slave address is determined by the state of the A0 pin.

Typical Application

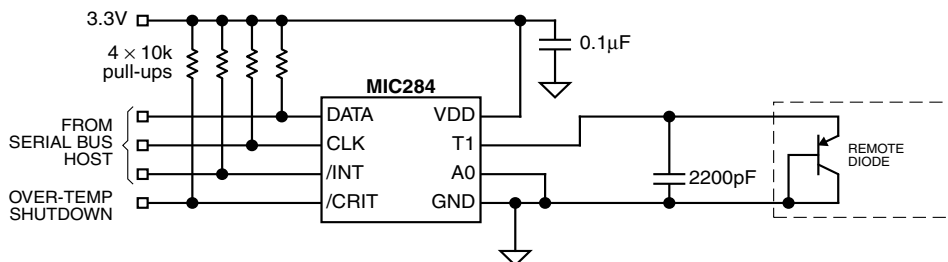

2-Channel SMBus Temperature Measurement System

Pin Configuration

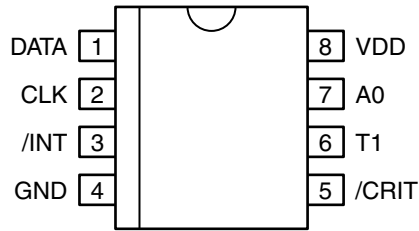

Pin Description

Pin Number	Pin Name	Pin Function
1	DATA	Digital I/O: Open-drain. Serial data input/output.
2	CLK	Digital Input: The host provides the serial bit clock on this input.
3	/INT	Digital Output: Open-drain. Interrupt or thermostat output.
4	GND	Ground: Power and signal return for all IC functions.
5	/CRIT	Digital Output: Open-Drain. Over-temperature indication
6	T1	Analog Input: Connection to remote temperature sensor (diode junction)
7	A0	Digital Input: Slave address selection input. See Table 1. MIC284 Slave Address Settings.
8	VDD	Analog Input: Power supply input to the IC.

Absolute Maximum Ratings (Note 1)

Power Supply Voltage, V_{DD}	6.0V
Voltage on Any Pin	-0.3V to $V_{DD}+0.3V$
Current Into Any Pin	± 10 mA
Power Dissipation, $T_A = +125^\circ\text{C}$	30mW
Junction Temperature	+150°C
Storage Temperature	-65°C to +150°C
ESD Ratings (Note 3)	
Human Body Model	TBD V
Machine Model	TBD V
Soldering	
Vapor Phase (60 sec.)	+220°C $+5/-0^\circ\text{C}$
Infrared (15 sec.)	+235°C $+5/-0^\circ\text{C}$

Operating Ratings (Note 2)

Power Supply Voltage, V_{DD}	+2.7V to +5.5V
Ambient Temperature Range (T_A)	-55°C to +125°C
Package Thermal Resistance (θ_{JA})	
SOP	+152°C/W
MSOP	+206°C/W

Electrical Characteristics

2.7V $\leq V_{DD} \leq 5.5$; $T_A = +25^\circ\text{C}$, **bold** values indicate $-55^\circ\text{C} \leq T_A \leq +125^\circ\text{C}$, **Note 4**; unless noted.

Symbol	Parameter	Condition	Min	Typ	Max	Units
Power Supply						
I_{DD}	Supply Current	/INT, open, $A0 = V_{DD}$ or GND, CLK = DATA = high, normal mode		350	750	μA
		/INT, /CRIT open, $A0 = V_{DD}$ or GND shutdown mode, CLK = 100kHz		3		μA
		/INT, /CRIT open, $A0 = V_{DD}$ or GND shutdown mode, CLK = DATA = high		1	10	μA
t_{POR}	Power-On Reset Time, Note 7	$V_{DD} > V_{POR}$			200	μs
V_{POR}	Power-On Reset Voltage	all registers reset to default values, A/D conversions initiated		2.0	2.7	V
V_{HYST}	Power-On Reset Hysteresis Voltage			250		mV
Temperature-to-Digital Converter Characteristics						
	Accuracy—Local Temperature Note 4, 9	$0^\circ\text{C} \leq T_A \leq +100^\circ\text{C}$, /INT and /CRIT open, $3V \leq V_{DD} \leq 3.6V$		± 1	± 2	$^\circ\text{C}$
		$-55^\circ\text{C} \leq T_A \leq +125^\circ\text{C}$, /INT and /CRIT open, $3V \leq V_{DD} \leq 3.6V$		± 2	± 3	$^\circ\text{C}$
	Accuracy—Remote Temperature Note 4, 5, 9	$0^\circ\text{C} \leq T_D \leq +100^\circ\text{C}$, /INT and /CRIT open, $3V \leq V_{DD} \leq 3.6V$, $0^\circ\text{C} \leq T_A \leq +85^\circ\text{C}$		± 1	± 3	$^\circ\text{C}$
		$-55^\circ\text{C} \leq T_D \leq +125^\circ\text{C}$, /INT and /CRIT open, $3V \leq V_{DD} \leq 3.6V$, $0^\circ\text{C} \leq T_A \leq +85^\circ\text{C}$		± 2	± 5	$^\circ\text{C}$
t_{CONV0}	Conversion Time, local zone Note 7			50	80	ms
t_{CONV1}	Conversion Time, remote zone Note 7			100	160	ms
Remote Temperature Input (T1)						
I_F	Current to External Diode Note 7	high level, T1 forced to 1.5V		224	400	μA
		low level	7.5	14		μA
Address Input (A0)						
V_{IL}	Low Input Voltage	$2.7V \leq V_{DD} \leq 5.5V$			0.6	V
V_{IH}	High Input Voltage	$2.7V \leq V_{DD} \leq 5.5V$	2.0			V
C_{IN}	Input Capacitance			10		pF
I_{LEAK}	Input Current			± 0.01	± 1	μA

Symbol	Parameter	Condition	Min	Typ	Max	Units
Serial Data I/O Pin (DATA)						
V_{OL}	Low Output Voltage Note 6	$I_{OL} = 3mA$			0.4	V
		$I_{OL} = 6mA$			0.8	V
V_{IL}	Low Input Voltage	$2.7V \leq V_{DD} \leq 5.5V$			$0.3V_{DD}$	V
V_{IH}	High Input Voltage	$2.7V \leq V_{DD} \leq 5.5V$	$0.7V_{DD}$			V
C_{IN}	Input Capacitance			10		pF
I_{LEAK}	Input current			± 0.01	± 1	μA
Serial Clock Input (CLK)						
V_{IL}	Low Input Voltage	$2.7V \leq V_{DD} \leq 5.5V$			$0.3V_{DD}$	V
V_{IH}	High Input Voltage	$2.7V \leq V_{DD} \leq 5.5V$	$0.7V_{DD}$			V
C_{IN}	Input Capacitance			10		pF
I_{LEAK}	Input current			± 0.01	± 1	μA
Status Output (/INT)						
V_{OL}	Low Output Voltage, Note 6	$I_{OL} = 3mA$			0.4	V
		$I_{OL} = 6mA$			0.8	V
t_{INT}	Interrupt Propagation Delay, Note 7, 8	from $TEMP > T_{SET}$ or $TEMPx < T_{HYSTx}$ to $INT < V_{OL}$, $FQ = 00$, $R_{PULLUP} = 10k\Omega$			t_{CONV+1}	μs
t_{nINT}	Interrupt Reset Propagation Delay, Note 7	from any register read to $/INT > V_{OH}$ $FQ = 00$, $R_{PULLUP} = 10k\Omega$			1	μs
T_{SET0}	Default T_{SET0} Value	t_{POR} after $V_{DD} > V_{POR}$	81	81	81	$^{\circ}C$
T_{HYST0}	Default T_{HYST0} Value	t_{POR} after $V_{DD} > V_{POR}$	76	76	76	$^{\circ}C$
T_{SET1}	Default T_{SET1} Value	t_{POR} after $V_{DD} > V_{POR}$	97	97	97	$^{\circ}C$
T_{HYST1}	Default T_{HYST1} Value	t_{POR} after $V_{DD} > V_{POR}$	92	92	92	$^{\circ}C$
Over-Temperature Output (/CRIT)						
V_{OL}	Low Output Voltage, Note 6	$I_{OL} = 3mA$			0.4	V
		$I_{OL} = 6mA$			0.8	V
t_{CRIT}	/CRIT Propagation Delay, Note 7, 8	from $TEMPx > T_{SETx}$ or $TEMPx < T_{HYSTx}$ to $INT < V_{OL}$, $FQ = 00$, $R_{PULLUP} = 10k\Omega$			t_{CONV+1}	μs
t_{nCRIT}	/CRIT Reset Propagation Delay, Note 7	from $TEMPx < nCRITx$ to $/CRIT > V_{OH}$ $FQ = 00$, $R_{PULLUP} = 10k\Omega$			1	μs
$CRIT1$	Default $CRIT1$ Value	t_{POR} after $V_{DD} > V_{POR}$	97	97	97	$^{\circ}C$
$nCRIT1$	Default $nCRIT1$ Value	t_{POR} after $V_{DD} > V_{POR}$	92	92	92	$^{\circ}C$
Serial Interface Timing (Note 7)						
t_1	CLK (Clock) Period		2.5			μs
t_2	Data In Setup Time to CLK High		100			ns
t_3	Data Out Stable After CLK Low		0			ns
t_4	DATA Low Setup Time to CLK Low	start condition	100			ns
t_5	DATA High Hold Time After CLK High	stop condition	100			ns

- Note 1.** Exceeding the absolute maximum rating may damage the device.
- Note 2.** The device is not guaranteed to function outside its operating rating.
- Note 3.** Devices are ESD sensitive. Handling precautions recommended.
Human body model: 1.5k in series with 100pF. Machine model: 200pF, no series resistance.
- Note 4.** Final test on outgoing product is performed at $T_A = TBD^\circ\text{C}$.
- Note 5.** T_D is the temperature of the remote diode junction. Testing is performed using a single unit of one of the transistors listed in Table 6.
- Note 6.** Current into this pin will result in self-heating of the MIC284. Sink current should be minimized for best accuracy.
- Note 7.** Guaranteed by design over the operating temperature range. Not 100% production tested.
- Note 8.** $t_{\text{CONV}} = t_{\text{CONV0}} + t_{\text{CONV1}} \cdot t_{\text{CONV0}}$ is the conversion time for the local zone; t_{CONV1} is the conversion time for the remote zone.
- Note 9.** Accuracy specification does not include quantization noise, which may be as great as $\pm 1/2\text{LSB}$ ($\pm 0.5^\circ\text{C}$).

Timing Diagram

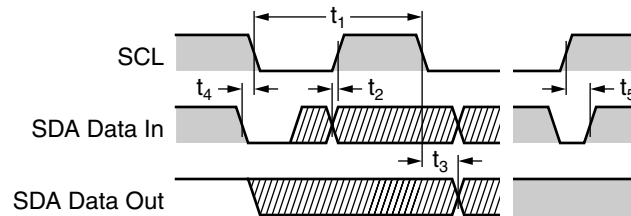

Serial Interface Timing

Functional Diagram

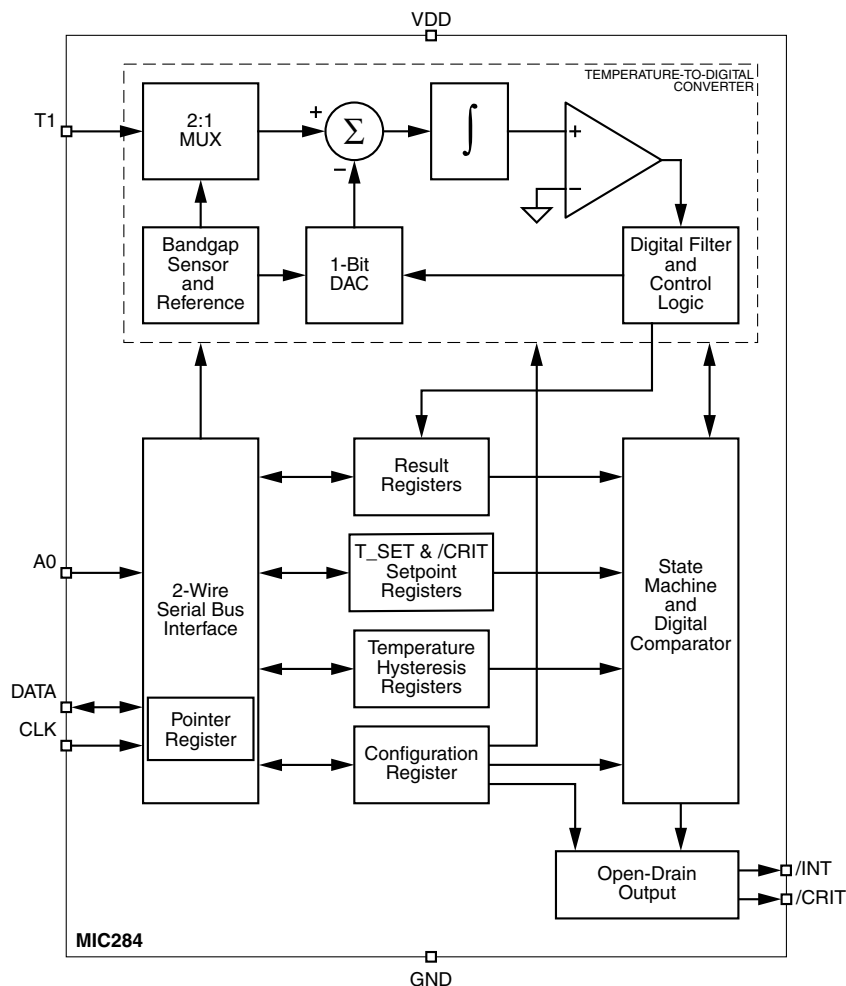

FUNCTIONAL DESCRIPTION

Pin Descriptions

VDD: Power supply input. See electrical specifications.

GND: Ground return for all MIC284 functions.

CLK: Clock input to the MIC284 from the two-wire serial bus. The clock signal is provided by the host, and is shared by all devices on the bus.

DATA: Serial data I/O pin that connects to the two-wire serial bus. DATA is bi-directional and has an open-drain output driver. An external pull-up resistor or current source somewhere in the system is necessary on this line. This line is shared by all devices on the bus.

A0: This inputs sets the least significant bit of the MIC284's 7-bit slave address. The six most-significant bits are fixed and are determined by the part number ordered. (See ordering information table above.) Each MIC284 will only respond to its own unique slave address, allowing up to eight MIC284s to share a single bus. A match between the MIC284's address and the address specified in the serial bit stream must be made to initiate communication. A0 should be tied directly to VDD or ground. See "Temperature Measurement

and Power On" for more information. A0 determines the slave address as shown in Table 1:

Part Number	Inputs	MIC284 Slave Address	
	A0	Binary	Hex
MIC284-0	0	100 1000 _b	48 _h
	1	100 1001 _b	49 _h
MIC284-1	0	100 1010 _b	4A _h
	1	100 1011 _b	4B _h
MIC284-2	0	100 1100 _b	4C _h
	1	100 1101 _b	4D _h
MIC284-3	0	100 1110 _b	4E _h
	1	100 1111 _b	4F _h

Table 1. MIC284 Slave Address Settings

/INT: Temperature events are indicated to external circuitry via this output. Operation of the /INT output is controlled by the MODE and IM bits in the MIC284's configuration register. See "Comparator and Interrupt Modes" below. This output is open-drain and may be wire-OR'ed with other open-drain signals. Most systems will require a pull-up resistor or current source on this pin. If the IM bit in the configuration register is

set, it prevents the /INT output from sinking current. In I²C and SMBus systems, the IM bit is therefore an interrupt mask bit.

/CRIT: Over-temperature events are indicated to external circuitry via this output. This output is open-drain and may be wire-OR'ed with other open-drain signals. Most systems will require a pull-up resistor or current source on this pin.

T1: This pin connects to an off-chip PN diode junction, for monitoring the junction temperature at a remote location. The remote diode may be an embedded thermal sensing junction in an integrated circuit so equipped (such as Intel's Pentium III), or a discrete 2N3906-type bipolar transistor with base and collector tied together.

Temperature Measurement

The temperature-to-digital converter is built around a switched current source and an eight-bit analog-to-digital converter. Each diode's temperature is calculated by measuring its forward voltage drop at two different current levels. An internal multiplexer directs the MIC284's current source output to either an internal or external diode junction. The MIC284 uses two's-complement data to represent temperatures. If the MSB of a temperature value is zero, the temperature is zero or positive. If the MSB is one, the temperature is negative. More detail on this is given in the "Temperature Data Format" section below. A "temperature event" results if the value in either of the temperature result registers (TEMPx) becomes greater than the value in the corresponding temperature setpoint register (T_SETx). Another temperature event occurs if and when the measured temperature subsequently falls below the temperature hysteresis setting in T_HYSTx.

During normal operation the MIC284 continuously performs temperature-to-digital conversions, compares the results against the setpoint registers, and updates the states of /INT, /CRIT, and the status bits accordingly. The remote zone is converted first, followed by the local zone. The states of /INT, /CRIT, and the status bits are updated after each measurement is taken. The remote diode junction connected to T1 may be embedded in an integrated circuit such as a CPU, ASIC, or graphics processor, or it may be a diode-connected discrete transistor.

Diode Faults

The MIC284 is designed to respond in a failsafe manner to hardware faults in the external sensing circuitry. If the connection to the external diode is lost or the sense line (T1) is shorted to VDD or ground, the temperature data reported by the A/D converter will be forced to its full-scale value (+127°C). This will cause a temperature event to occur if T_SET1 or CRIT1 are set to any value less than 127°C ($7F_h = 0111\ 1111_b$). An interrupt will be generated on /INT if so enabled. The temperature reported for the external zone will remain +127°C until the fault condition is cleared. This fault detection mechanism requires that the MIC284 complete the number of conversion cycles specified by Fault_Queue. The part will therefore require one or more conversion cycles following power-on or a transition from shutdown to normal operation before reporting an external diode fault.

Serial Port Operation

The MIC284 uses standard SMBus Write_Byte and Read_Byte operations for communication with its host. The SMBus Write_Byte operation involves sending the device's slave address (with the R/W bit low to signal a write operation), followed by a command byte and a data byte. The SMBus Read_Byte operation is similar, but is a composite write and read operation: the host first sends the device's slave address followed by the command byte, as in a write operation. A new start bit must then be sent to the MIC284, followed by a repeat of the slave address with the R/W bit (LSB) set to the high (read) state. The data to be read from the part may then be clocked out.

The command byte is eight bits wide. This byte carries the address of the MIC284 register to be operated upon, and is stored in the part's pointer register. The pointer register is an internal write-only register. The command byte (pointer register) values corresponding to the various MIC284 register addresses are shown in Table 2. Command byte values other than those explicitly shown are reserved, and should not be used. Any command byte sent to the MIC284 will persist in the pointer register indefinitely until it is overwritten by another command byte. If the location latched in the pointer register from the last operation is known to be correct (i.e., points to the desired register), then the Receive_Byte procedure may be used. To perform a Receive_Byte, the host sends an address byte to select the MIC284, and then retrieves the data byte. Figures 1 through 3 show the formats for these procedures.

Command_Byte		Target Register	
Binary	Hex	Label	Description
0000 0000 _b	00 _h	TEMP0	local temperature
0000 0001 _b	01 _h	CONFIG	configuration register
0000 0010 _b	02 _h	T_HYST0	local temperature hysteresis
0000 0011 _b	03 _h	T_SET0	local temperature setpoint
0001 0000 _b	10 _h	TEMP1	remote temperature
0001 0010 _b	12 _h	T_HYST1	remote temperature hysteresis
0001 0011 _b	13 _h	T_SET1	remote temperature setpoint
0010 0010 _b	22 _h	nCRIT1	over-temperature hysteresis
0010 0011 _b	23 _h	CRIT1	over-temperature setpoint

Table 2. MIC284 Register Addresses

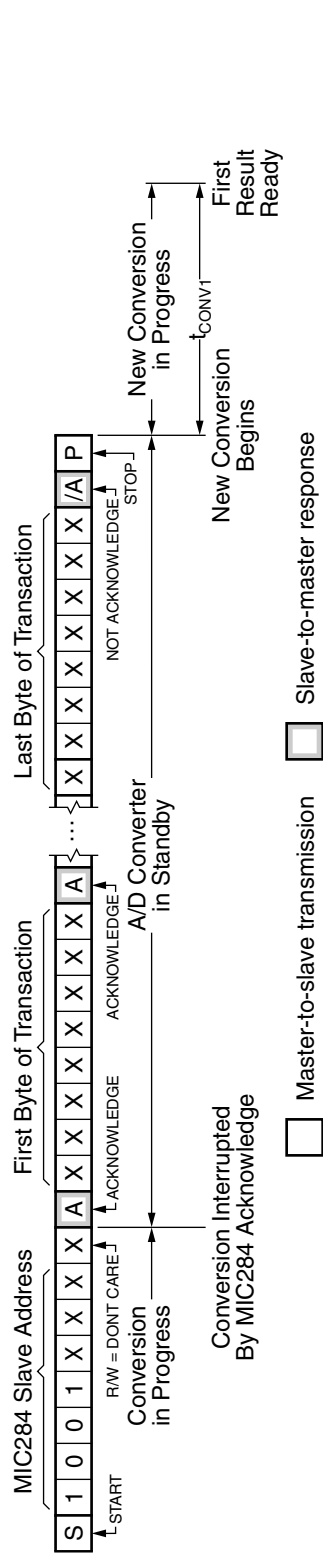

Figure 4. A/D Converter Timing

- Master-to-slave transmission
- Slave-to-master response

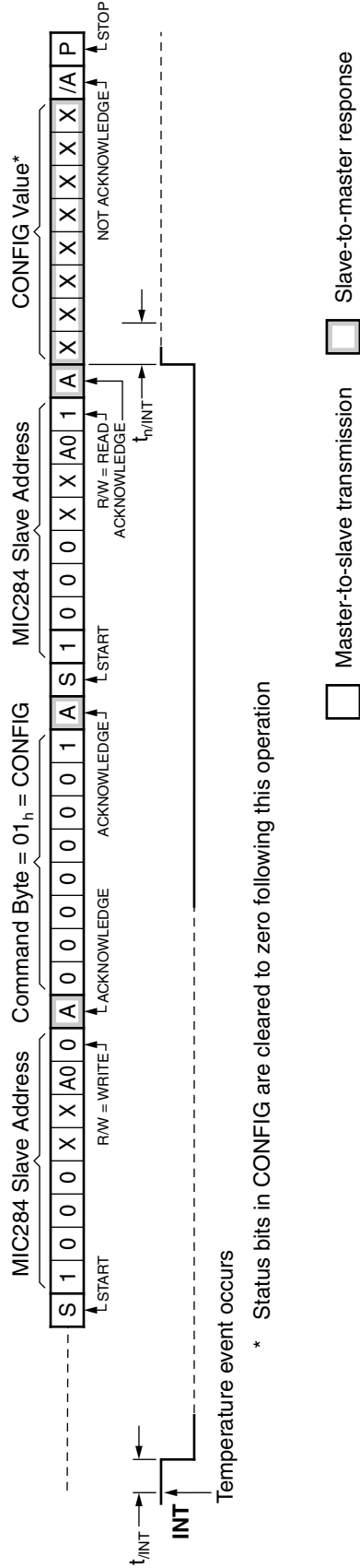

Figure 5. Responding to Interrupts

- Master-to-slave transmission
- Slave-to-master response

* Status bits in CONFIG are cleared to zero following this operation

Temperature Data Format

The LSB of each register represents one degree Centigrade. The values are in a two's complement format, wherein the most significant bit (D7), represents the sign: zero for positive temperatures and one for negative temperatures. Table 3 shows examples of the data format used by the MIC284 for temperatures.

A/D Converter Timing

Whenever the MIC284 is not in its low power shutdown mode, the internal A/D converter (ADC) attempts to make continuous conversions unless interrupted by a bus transaction accessing the MIC284. When the part is accessed, the conversion in progress will be halted, and the partial result discarded. When the access to the MIC284 is complete, the ADC will begin a new conversion cycle with results for the remote zone valid t_{CONV1} after that, and for the local zone t_{CONV0} later. Figure 4 shows this behavior. The conversion time is twice as long for external conversions as it is for internal conversions. This allows the use of a filter capacitor on T1 without a loss of accuracy due to the resulting longer settling times.

Upon powering-up, coming out of shutdown mode, or resuming operation following a serial bus transaction, the ADC will begin acquiring temperature data starting with the external zone (zone 1), followed by the internal zone (zone 0). If the ADC is interrupted by a serial bus transaction, it will restart the conversion that was interrupted and then continue in the normal sequence. This sequence will repeat indefinitely until the MIC284 is shut down, powered off, or is interrupted by a serial bus transaction as described above.

Power-On

When power is initially applied, the MIC284's internal registers are set to their default states, and A0 is read to establish the device's slave address. The MIC284's power-up default state can be summarized as follows:

- Normal Mode operation (i.e., part is not in shutdown)
- /INT function is set to Comparator Mode
- Fault Queue depth = 1 (FQ=00)
- Interrupts are enabled (IM = 0)
- T_SET0 = 81°C; T_HYST0 = 76°C
- T_SET1 = 97°C; T_HYST1 = 92°C
- CRIT1 = 97°C; nCRIT1 = 92°C
- Initialized to recognize overtemperature faults

Temperature	Binary	Hex
+125° C	0111 1101 _b	7D _h
+25° C	0001 1001 _b	19 _h
+1.0° C	0000 0001 _b	01 _h
0° C	0000 0000 _b	00 _h
- 1.0° C	1111 1111 _b	FF _h
- 25° C	1110 0111 _b	E7 _h
- 40° C	1101 1000 _b	D8 _h
- 55° C	1100 1001 _b	C9 _h

Table 3. Digital Temperature Format

Comparator and Interrupt Modes

Depending on the setting of the MODE bit in the configuration register, the /INT output will behave either as an interrupt request signal or a thermostatic control signal. Thermostatic operation is known as *comparator mode*. The /INT output is asserted when the measured temperature, as reported in either of the TEMPx registers, exceeds the threshold programmed into the corresponding T_SETx register for the number of conversions specified by Fault_Queue (described below). In comparator mode, /INT will remain asserted and the status bits will remain high unless and until the measured temperature falls below the value in the T_HYSTx register for Fault_Queue conversions. No action on the part of the host is required for operation in comparator mode. Note that entering shutdown mode will not affect the state of /INT when the device is in comparator mode.

In *interrupt mode*, once a temperature event has caused a status bit (Sx) to be set, and the /INT output to be asserted, they will not be automatically de-asserted when the measured temperature falls below T_HYSTx. They can only be de-asserted by reading any of the MIC284's internal registers or by putting the device into shutdown mode. If the most recent temperature event was an overtemperature condition, Sx will not be set again, and /INT cannot be reasserted, until the device has detected that TEMPx < T_HYSTx. Similarly, if the most recent temperature event was an undertemperature condition, Sx will not be set again, and /INT cannot be reasserted, until the device has detected that TEMPx > T_SETx. This keeps the internal logic of the MIC284 backward compatible with that of the LM75 and similar devices. In both modes, the MIC284 will be responsive to over-temperature events at power-up. See "Interrupt Generation", below.

Shutdown Mode

Setting the SHDN bit in the configuration register halts the otherwise continuous conversions by the A/D converter. The MIC284's power consumption drops to 1µA typical in shutdown mode. All registers may be read from or written to while in shutdown mode. Serial bus activity will slightly increase the part's power consumption.

Entering shutdown mode will not affect the state of /INT when the device is in comparator mode (MODE = 0). It will retain its state until after the device exits shutdown mode and resumes A/D conversions.

If the device is shut down while in interrupt mode (mode = 1), the /INT pin will be unconditionally de-asserted and the internal latches holding the interrupt status will be cleared. Therefore, no interrupts will be generated while the MIC284 is in shutdown mode, and the interrupt status will not be retained. Regardless of the setting of the MODE bit, the state of /CRIT and its corresponding status bit, CRIT1, does not change when the MIC284 enters shutdown mode. They will retain their states until after the device exits shutdown mode and resumes A/D conversions. Since entering shutdown mode stops A/D conversions, the MIC284 is incapable of detecting or reporting temperature events of any kind while in shutdown. Diode fault detection requires one or more A/D conversion cycles to detect external sensor faults, therefore diode faults will not be reported until the MIC284 exits shutdown (see "Diode Faults" above).

Fault Queues

Fault queues (programmable digital filters) are provided in the MIC284 to prevent false tripping due to thermal or electrical noise. The two bits in CONFIG[4:3] set the depth of Fault_Queue. Fault_Queue then determines the number of consecutive temperature events ($TEMPx > T_SETx$, $TEMPx < T_HYSTx$, $TEMP1 > CRIT1$, or $TEMP1 < nCRIT1$) which must occur in order for the condition to be considered valid. There are separate fault queues for each zone and for the over-temperature detect function. As an example, assume the part is in comparator mode, and CONFIG[4:3] is programmed with 10_b. The measured temperature in zone one would have to exceed T_SET1 for four consecutive A/D conversions before /INT would be asserted or the S1 status bit set. Similarly, TEMP1 would have to be less than T_HYST1 for four consecutive conversions before /INT would be reset. Like any filter, the fault queue function also has the effect of delaying the detection of temperature events. In this example, it would take $4 \times t_{CONV}$ to detect a temperature event. The depth of Fault_Queue vs. D[4:3] of the configuration register is shown in Table 4:

CONFIG[4:3]	Fault_Queue Depth
00	1 conversion*
01	2 conversions
10	4 conversions
11	6 conversions

* Default setting

Table 4. Fault_Queue Depth Settings

Interrupt Generation

Assuming the MIC284 is in interrupt mode and interrupts are enabled, there are five different conditions that will cause the MIC284 to set one of the status bits (S0, S1, or CRIT1) in CONFIG and assert the /INT output and/or the /CRIT output. These conditions are listed in Table 5. When a temperature event occurs, the corresponding status bit will be set in CONFIG. This action cannot be masked. However, a temperature event will only generate an interrupt signal on /INT if it is specifically enabled by the interrupt mask bit (IM = 0 in the configuration register). Following an interrupt, the host

should read the contents of the configuration register to confirm that the MIC284 was the source of the interrupt. A read operation on *any* register will cause /INT to be de-asserted. This is shown in Figure 5. The status bits will be cleared once CONFIG has been read.

Since temperature-to-digital conversions continue while /INT is asserted, the measured temperature could change between the MIC284's assertion of /INT or /CRIT and the host's response. It is good practice for the interrupt service routine to read the value in TEMPx, to verify that the over-temperature or under-temperature condition still exists. In addition, more than one temperature event may have occurred simultaneously or in rapid succession between the assertion of /INT and servicing of the MIC284 by the host. The interrupt service routine should allow for this eventuality. Keep in mind that clearing the status bits and deasserting /INT is *not* sufficient to allow further interrupts to occur. TEMPx must become less than T_HYSTx if the last event was an over-temperature condition, or greater than T_SETx if the last event was an under-temperature condition, before /INT can be asserted again.

Putting the device into shutdown mode will de-assert /INT and clear the S0 and S1 status bits. This should not be done before completing the appropriate interrupt service routine(s).

/CRIT Output

If and when the measured remote temperature exceeds the value programmed into the CRIT1 register, the /CRIT output will be asserted and CRIT1 in the configuration register will be set. If and when the measured temperature in zone one subsequently falls below the value programmed into nCRIT1, the /CRIT output will be de-asserted and the CRIT1 bit in CONFIG will be cleared. This action cannot be masked and is completely independent of the settings of the mode bit and interrupt mask bit. The host may poll the state of the /CRIT output at any time by reading the configuration register. The state of the CRIT1 bit exactly follows the state of the /CRIT output. The states of /CRIT and CRIT1 do not change when the MIC284 enters shutdown mode. Entering shutdown mode stops A/D conversions, however, so their states will not change while the device is shut down.

Polling

The MIC284 may either be polled by the host, or request the host's attention via the /INT pin. In the case of polled operation, the host periodically reads the contents of CONFIG to check the state of the status bits. The act of reading CONFIG clears the status bits. If more than one event that sets a given status bit occurs before the host polls the MIC284, only the fact that at least one such event has occurred will be apparent to the host. For polled systems, the interrupt mask bit should be set (IM = 1). This will disable interrupts from the MIC284, and prevent the /INT pin from sinking current. The host may poll the state of the /CRIT output at any time by reading the configuration register. The state of the CRIT1 bit exactly follows the state of the /CRIT output.

EVENT	CONDITION*	MIC284 Response**
High temperature, remote	TEMP1 > T_SET1	Set S1 in CONFIG, assert /INT
High temperature, local	TEMP0 > T_SET0	Set S0 in CONFIG, assert /INT
Low temperature, remote	TEMP1 < T_HYST1	Set S1 in CONFIG, assert /INT
Low temperature, local	TEMP0 < T_HYST0	Set S0 in CONFIG, assert /INT
Over-temperature, remote	TEMP1 > CRIT1	Set CRIT in CONFIG, assert /CRIT
NOT Over-temperature, remote	TEMP < nCRIT1	Clear CRIT in CONFIG, de-assert /CRIT
Diode Fault	T1 open or T1 shorted to VDD or GND	Set CRIT and S1 in CONFIG, assert /INT and /CRIT***

* CONDITION must be true for Fault_Queue conversions to be recognized

** Assumes interrupts enabled

*** Assumes that T_SET1 and CRIT1 are set to any value less than +127° C = 7F_h = 0111 1111_b

Table 5. MIC284 Temperature Events

Register Set and Programmer's Model

Internal Register Set

Name	Description	Command Byte	Operation	Power-Up Default
TEMP0	local temperature	00 _h	8-bit read only	00 _h (0° C) ⁽¹⁾
CONFIG	configuration register	01 _h	8-bit read/write	00 _h ⁽²⁾
T_HYST0	local hysteresis	02 _h	8-bit read/write	4C _h (+76° C)
T_SET0	local temperature setpoint	03 _h	8-bit read/write	51 _h (+81° C)
TEMP1	remote temperature	10 _h	8-bit read only	00 _h (0° C) ⁽¹⁾
T_HYST1	remote hysteresis	12 _h	8-bit read/write	5C _h (+92° C)
T_SET1	remote temperature setpoint	13 _h	8-bit read/write	61 _h (+97° C)
nCRIT1	over-temperature hysteresis	22 _h	8-bit read/write	5C _h (+92° C)
CRIT1	over-temperature temperature setpoint	23 _h	8-bit read/write	61 _h (+97° C)

- (1) TEMP0 and TEMP1 will contain measured temperature data after the completion of one conversion cycle.
 (2) After the first Fault_Queue conversions are complete, status bits will be set if TEMP_x > T_SET_x or TEMP1 > CRIT1.

Detailed Register Descriptions

Configuration Register

CONFIGURATION REGISTER (CONFIG)							
8-Bit Read/Write							
D[7]	D[6]	D[5]	D[4]	D[3]	D[2]	D[1]	D[0]
read only	read only	read only	read/write		read/write	read/write	read/write
local status (S0)	remote status (S1)	/CRIT status (CRIT1)	fault queue depth (FQ[1:0])		interrupt mask (IM)	CMP/INT mode (MODE)	Shutdown (SHDN)

Bits	Function	Operation
S0	local interrupt status (read only)	1 = event occurred, 0 = no event
S1	remote interrupt status (read only)	1 = event occurred, 0 = no event
CRIT1	remote over-temperature status (read only)	1 = over-temperature, 0 = no event
FQ[1:0]	Fault_Queue depth	00 = 1 conversion, 01 = 2 conversions, 10 = 4 conversions, 11 = 6 conversions
IM	interrupt mask	1 = disabled, 0 = interrupts enabled
MODE	comparator/interrupt mode selection for /INT pin	1 = interrupt mode, 0 = comparator mode
SHDN	normal/shutdown operating mode selection	1 = shutdown, 0 = normal

CONFIG Power-Up Value: 0000 0000_b = 00_h^(*)

- not in shutdown mode
- comparator mode
- /INT = active low
- Fault_Queue depth = 1
- interrupts enabled.
- no temperature events pending

CONFIG Command Byte Value: 0000 0001_b = 01_h

* Following the first Fault_Queue conversions, one or more of the status bits may be set.

Local Temperature Result Register

LOCAL TEMPERATURE RESULTS (TEMP0) 8-Bit Read Only							
D[7]	D[6]	D[5]	D[4]	D[3]	D[2]	D[1]	D[0]
MSB	bit 6	bit 5	bit 4	bit 3	bit 2	bit 1	LSB
local temperature data from ADC*							
Bits	Function			Operation			
D[7:0]	measured temperature data for the local zone*			read only			

TEMP0 Power-Up Value: $0000\ 0000_b = 00_h (0^\circ\text{C})^\dagger$

TEMP0 Command Byte Value: $0000\ 0000_b = 00_h$

* Each LSB represents one degree Centigrade. The values are in a two's complement format such that 0°C is reported as $0000\ 0000_b$. See "Temperature Data Format" for more details.

† TEMP0 will contain measured temperature data after the completion of one conversion.

Local Temperature Hysteresis Register

LOCAL TEMPERATURE HYSTERESIS (T_HYST0) 8-Bit Read/Write							
D[7]	D[6]	D[5]	D[4]	D[3]	D[2]	D[1]	D[0]
MSB	bit 6	bit 5	bit 4	bit 3	bit 2	bit 1	LSB
local temperature hysteresis setting							
Bits	Function			Operation			
D[7:0]	local temperature hysteresis setting*			read/write			

T_HYST0 Power-Up Value: $0100\ 1100_b = 4C_h (+76^\circ\text{C})$

T_HYST0 Command Byte Value: $0000\ 0010_b = 02_h$

* Each LSB represents one degree Centigrade. The values are in a two's complement format such that 0°C is reported as $0000\ 0000_b$. See "Temperature Data Format" for more details.

Local Temperature Setpoint Register

LOCAL TEMPERATURE SETPOINT (T_SET0) 8-Bit Read/Write							
D[7]	D[6]	D[5]	D[4]	D[3]	D[2]	D[1]	D[0]
MSB	bit 6	bit 5	bit 4	bit 3	bit 2	bit 1	LSB
local temperature setpoint							
Bits	Function			Operation			
D[7:0]	local temperature setpoint*			read/write			

T_SET0 Power-Up Value: $0101\ 0001_b = 51_h (+81^\circ\text{C})$

T_SET0 Command Byte Value: $0000\ 0011_b = 03_h$

* Each LSB represents one degree Centigrade. The values are in a two's complement format such that 0°C is reported as $0000\ 0000_b$. See "Temperature Data Format" for more details.

Remote Temperature Result Register

REMOTE TEMPERATURE RESULT (TEMP1) 8-Bit Read Only							
D[7]	D[6]	D[5]	D[4]	D[3]	D[2]	D[1]	D[0]
MSB	bit 6	bit 5	bit 4	bit 3	bit 2	bit 1	LSB
remote temperature data from ADC*							
Bits	Function			Operation			
D[7:0]	measured temperature data for the remote zone*			read only			

TEMP1 Power-Up Value: $0000\ 0000_b = 00_h$ (0°C)[†]

TEMP1 Command Byte Value: $0001\ 0000_b = 10_h$

* Each LSB represents one degree Centigrade. The values are in a two's complement format such that 0°C is reported as $0000\ 0000_b$. See "Temperature Data Format" for more details.

† TEMP1 will contain measured temperature data for the selected zone after the completion of one conversion.

Remote Temperature Hysteresis Register

REMOTE TEMPERATURE HYSTERESIS (T_HYST1) 8-Bit Read/Write							
D[7]	D[6]	D[5]	D[4]	D[3]	D[2]	D[1]	D[0]
MSB	bit 6	bit 5	bit 4	bit 3	bit 2	bit 1	LSB
remote temperature hysteresis setting							
Bits	Function			Operation			
D[7:0]	remote temperature hysteresis setting*			read/write			

T_HYST1 Power-Up Value: $0101\ 1100_b = 5C_h$ ($+92^\circ\text{C}$)

T_HYST1 Command Byte Value: $0001\ 0010_b = 12_h$

* Each LSB represents one degree Centigrade. The values are in a two's complement format such that 0°C is reported as $0000\ 0000_b$. See "Temperature Data Format" for more details.

Remote Temperature Setpoint Register

REMOTE TEMPERATURE SETPOINT (T_SET1) 8-Bit Read/Write							
D[7]	D[6]	D[5]	D[4]	D[3]	D[2]	D[1]	D[0]
MSB	bit 6	bit 5	bit 4	bit 3	bit 2	bit 1	LSB
remote temperature setpoint							
Bits	Function			Operation			
D[7:0]	remote temperature setpoint*			read/write			

T_SET1 Power-Up Value: $0110\ 0001_b = 61_h$ ($+97^\circ\text{C}$)

T_SET1 Command Byte Value: $0001\ 0011_b = 13_h$

* Each LSB represents one degree Centigrade. The values are in a two's complement format such that 0°C is reported as $0000\ 0000_b$. See "Temperature Data Format" for more details.

Remote Over-Temperature Hysteresis Register

REMOTE OVER-TEMPERATURE HYSTERESIS (nCRIT1)							
8-Bit Read/Write							
D[7]	D[6]	D[5]	D[4]	D[3]	D[2]	D[1]	D[0]
MSB	bit 6	bit 5	bit 4	bit 3	bit 2	bit 1	LSB
remote over-temperature hysteresis setting							
Bits	Function			Operation			
D[7:0]	remote temperature hysteresis setting*			read/write			

nCRIT Power-Up Value: $0101\ 1100_b = 5C_h (+92^\circ\text{C})$

nCRIT1 Command Byte Value: $0010\ 0010_b = 22_h$

* Each LSB represents one degree Centigrade. The values are in a two's complement format such that 0°C is reported as $0000\ 0000_b$. See "Temperature Data Format" for more details.

Remote Over-Temperature Setpoint Register

REMOTE OVER-TEMPERATURE SETPOINT (CRIT1)							
8-Bit Read/Write							
D[7]	D[6]	D[5]	D[4]	D[3]	D[2]	D[1]	D[0]
MSB	bit 6	bit 5	bit 4	bit 3	bit 2	bit 1	LSB
remote over-temperature setpoint							
Bits	Function			Operation			
D[7:0]	remote over-temperature setpoint*			read/write			

CRIT1 Power-Up Value: $0110\ 0001_b = 61_h (+97^\circ\text{C})$

CRIT1 Command Byte Value: $0010\ 0011_b = 23_h$

* Each LSB represents one degree Centigrade. The values are in a two's complement format such that 0°C is reported as $0000\ 0000_b$. See "Temperature Data Format" for more details.

Applications

Remote Diode Selection

Most small-signal PNP transistors with characteristics similar to the JEDEC 2N3906 will perform well as remote temperature sensors. Table 6 lists several examples of such parts that Micrel has tested for use with the MIC284. Other transistors equivalent to these should also work well.

Minimizing Errors

Self-Heating

One concern when using a part with the temperature accuracy and resolution of the MIC284 is to avoid errors induced by self-heating ($V_{DD} \times I_{DD}$) + ($V_{OL} \times I_{OL}$). In order to understand what level of error this might represent, and how to reduce that error, the dissipation in the MIC284 must be calculated and its effects reduced to a temperature offset.

The worst-case operating condition for the MIC284 is when $V_{DD} = 5.5V$, MSOP-08 package. The maximum power dissipated in the part is given in Equation 1 below.

In most applications, the /INT output will be low for at most a few milliseconds before the host resets it back to the high state, making its duty cycle low enough that its contribution to self-heating of the MIC284 is negligible. Similarly, the DATA pin will in all likelihood have a duty cycle of substantially below 25% in the low state. These considerations, combined with more typical device and application parameters, give a better system-level view of device self-heating in interrupt-mode usage. This is illustrated by Equation 2.

If the part is to be used in comparator mode, calculations similar to those shown in Equation 2 (accounting for the expected value and duty cycle of $I_{OL(/INT)}$ and $I_{OL(/CRIT)}$) will give a good estimate of the device's self-heating error.

In any application, the best test is to verify performance against calculation in the final application environment. This is especially true when dealing with systems for which some

of the thermal data (e.g., PC board thermal conductivity and ambient temperature) may be poorly defined or unobtainable except by empirical means.

Series Resistance

The operation of the MIC284 depends upon sensing the ΔV_{CB-E} of a diode-connected PNP transistor ("diode") at two different current levels. For remote temperature measurements, this is done using an external diode connected between T1 and ground.

Since this technique relies upon measuring the relatively small voltage difference resulting from two levels of current through the external diode, any resistance in series with the external diode will cause an error in the temperature reading from the MIC284. A good rule of thumb is this: for each ohm in series with the external transistor, there will be a 0.9°C error in the MIC284's temperature measurement. It isn't difficult to keep the series resistance well below an ohm (typically < 0.1Ω), so this will rarely be an issue.

Filter Capacitor Selection

It is sometimes desirable to use a filter capacitor between the T1 and GND pins of the MIC284. The use of this capacitor is recommended in environments with a lot of high frequency noise (such as digital switching noise), or if long wires are used to attach to the remote diode. The maximum recommended total capacitance from the T1 pin to GND is 2700pF. This typically suggests the use of a 2200pF NPO or C0G ceramic capacitor with a 10% tolerance.

If the remote diode is to be at a distance of more than ≈ 6" — 12" from the MIC284, using twisted pair wiring or shielded microphone cable for the connections to the diode can significantly help reduce noise pickup. If using a long run of shielded cable, remember to subtract the cable's conductor-to-shield capacitance from the 2700pF maximum total capacitance.

$$P_D = [(I_{DD} \times V_{DD}) + (I_{OL(DATA)} \times V_{OL(DATA)}) + (I_{OL(/INT)} \times V_{OL(/INT)}) + (I_{OL(/CRIT)} \times V_{OL(/CRIT)})]$$

$$P_D = [(0.75mA \times 5.5V) + (6mA \times 0.8V) + (6mA \times 0.8V) + (6mA \times 0.8V)]$$

$$P_D = 18.53mW$$

$$R_{\theta(j-a)} \text{ of MSOP-08 package is } 206^\circ C / W$$

$$\text{Maximum } \Delta T_J \text{ relative to } T_A \text{ due to self heating is } 18.53mW \times 206^\circ C / W = 3.82^\circ C$$

Equation 1. Worst-case self-heating

$$[(0.35mA I_{DD(typ)} \times 3.3V) + (25\% \times 1.5mA I_{OL(DATA)} \times 0.3V) + (1\% \times 1.5mA I_{OL(/INT)} \times 0.3V) + (25\% \times 1.5mA I_{OL(/CRIT)} \times 0.3V)] = 1.38mW$$

$$\Delta T_J = (1.38mW \times 206^\circ C / W) = 0.29^\circ C$$

Equation 2. Real-world self-heating example

Vendor	Part Number	Package
Fairchild	MMBT3906	SOT-23
On Semiconductor	MMBT3906L	SOT-23
Phillips Semiconductor	PMBT3906	SOT-23
Samsung	KST3906-TF	SOT-23

Table 6. Transistors Suitable for Remote Temperature Sensing Use

Layout Considerations

The following guidelines should be kept in mind when designing and laying out circuits using the MIC284:

1. Place the MIC284 as close to the remote diode as possible, while taking care to avoid severe noise sources such as high frequency power transformers, CRTs, memory and data busses, and the like.
2. Since any conductance from the various voltages on the PC Board and the T1 line can induce serious errors, it is good practice to guard the remote diode's emitter trace with a pair of ground traces. These ground traces should be returned to the MIC284's own ground pin. They should not be grounded at any other part of their run. However, it is highly desirable to use these guard traces to carry the diode's own ground return back to the ground pin of the MIC284, thereby providing a Kelvin connection for the base of the diode. See Figure 6.
3. When using the MIC284 to sense the temperature of a processor or other device which has an integral thermal diode, e.g., Intel's Pentium III, connect the emitter and base of the remote sensor to the MIC284 using the guard traces and Kelvin return shown in Figure 6. The collector of the remote diode is typically inaccessible to the user on these devices. To allow for this, the MIC284 has superb rejection of noise appearing from collector to GND, as long as the base to ground connection is relatively quiet.
4. Due to the small currents involved in the measurement of the remote diode's ΔV_{BE} , it is important to adequately clean the PC board after soldering to prevent current leakage. This is most likely to show up as an issue in situations where water-soluble soldering fluxes are used.
5. In general, wider traces for the ground and T1 lines will help reduce susceptibility to radiated noise (wider traces are less inductive). Use trace widths and spacing of 10 mils wherever possible and provide a ground plane under the MIC284 and under the connections from the MIC284 to the remote diode. This will help guard against stray noise pickup.
6. Always place a good quality power supply bypass capacitor directly adjacent to, or underneath, the MIC284. This should be a 0.1 μ F ceramic capacitor. Surface-mount parts provide the best bypassing because of their low inductance.
7. When the MIC284 is being powered from particularly noisy power supplies, or from supplies which may have sudden high-amplitude spikes appearing on them, it can be helpful to add additional power supply filtering. This should be implemented as a 100 Ω resistor in series with the part's VDD pin, and a 4.7 μ F, 6.3V electrolytic capacitor from VDD to GND. See Figure 7.

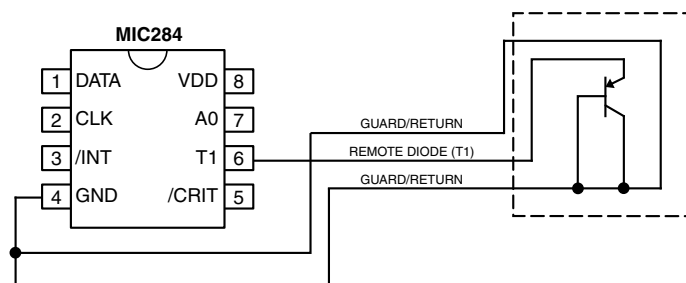

Figure 6. Guard Traces/Kelvin Ground Returns

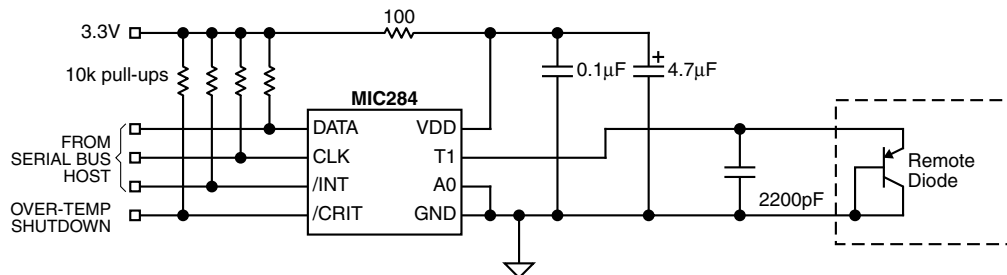
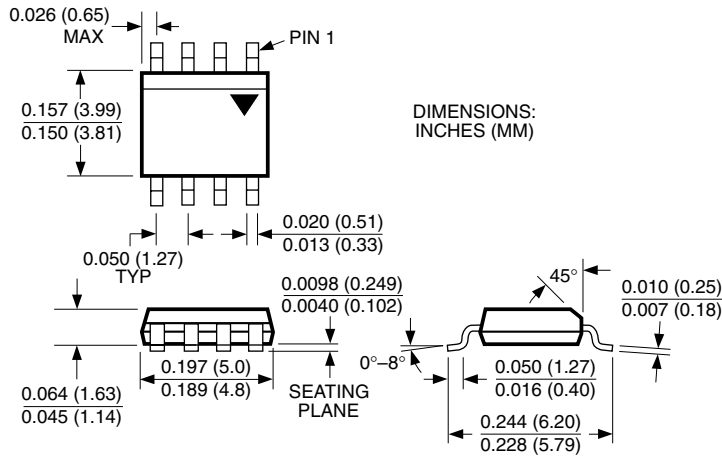
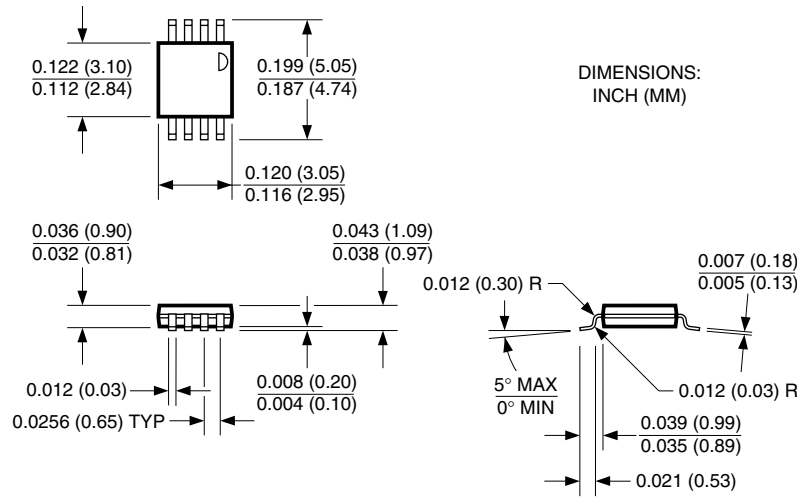

Figure 7. V_{DD} Decoupling for Very Noisy Supplies

Package Information



8-Lead SOP (M)



8-Lead MSOP (MM)

MICREL INC. 1849 FORTUNE DRIVE SAN JOSE, CA 95131 USA

TEL + 1 (408) 944-0800 FAX + 1 (408) 944-0970 WEB <http://www.micrel.com>

This information is believed to be accurate and reliable, however no responsibility is assumed by Micrel for its use nor for any infringement of patents or other rights of third parties resulting from its use. No license is granted by implication or otherwise under any patent or patent right of Micrel Inc.

© 2000 Micrel Incorporated