

MITSUBISHI MICROCOMPUTERS M35052-XXXSP/FP

SCREEN CHARACTER and PATTERN DISPLAY CONTROLLERS

DESCRIPTION

The M35052-XXXSP/FP is TV screen display control IC which can be used to display information such as number of channels, the date and messages and program schedules on the TV screen.

In particular, owing to the built-in SYNC-SEP (synchronous separation) circuit, the synchronous correction circuit, the Decoder circuit, and to the Encoder circuit, external circuits can be decrease and character turbulence that occurs when superimposing can be reduced. The processor can conform to the EDS broadcast service and is suitable for AV systems such as VTRs, LDs, and so on.

It is a silicon gate CMOS process and M35052-XXXSP is housed in a 20-pin shrink DIP package, M35052-XXXFP is housed in a 20-pin shrink SOP package.

For M35052-001SP/FP that is a standard ROM version of M35052-XXXSP/FP respectively, the character pattern is also mentioned.

FEATURES

- Screen composition 24 characters X 10 lines,
32 characters X 7 lines
- Number of characters displayed 240 (Max.)
- Character composition 12 X 18 dot matrix
- Characters available 128 characters
- Character sizes available 4 (horizontal) X 4 (vertical)
- Display locations available
 - Horizontal direction 240 locations
 - Vertical direction 256 locations
- Blinking Character units
 - Cycle : approximately 1 second, or approximately 0.5 seconds
 - Duty : 25%, 50%, or 75%
- Data input By the serial input function (16 bits)
- Coloring
 - Background coloring (composite video signal)
- Blanking
 - Total blanking (14 X 18 dots)
 - Border size blanking
 - Character size blanking
- Synchronizing signal
 - Composite synchronizing signal generation (PAL, NTSC, M-PAL)
- 2 output ports (1 digital line)
- Oscillation stop function
 - It is possible to stop the oscillation for synchronizing signal generation
- Built-in half-tone display function
- Built-in reversed character display function
- Built-in Decoder (NTSC only)
- Built-in Encoder (NTSC only)
- Built-in synchronous correction circuit
- Built-in synchronous separation circuit

APPLICATION

TV, VCR, Movie

PIN CONFIGURATION (TOP VIEW)

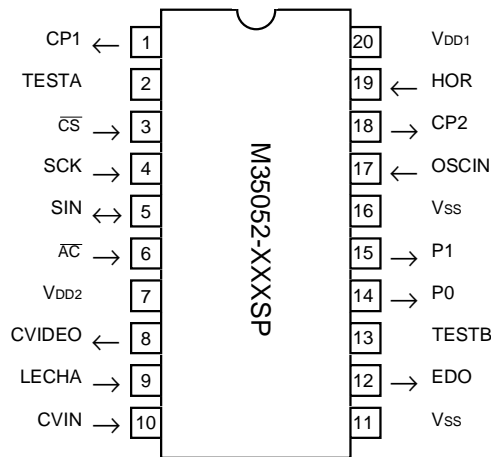

Outline 20P4B

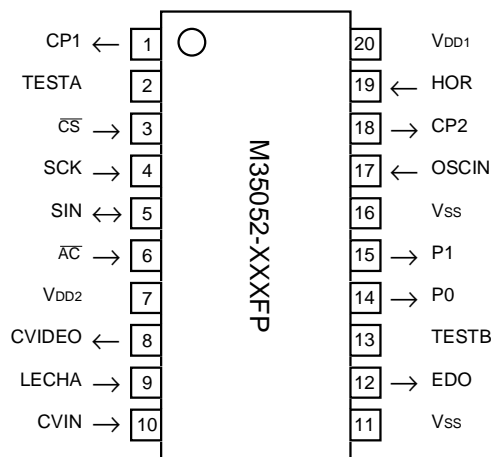

Outline 20P2Q-A

PIN DESCRIPTION

Symbol	Pin name	Input/ Output	Function
OSC1	Clock input	Input	This is the filter output pin 1.
TESTA	Test pin	—	This is the pin for test. Connect this pin to GND during normal operation.
CS	Chip select input	Input	This is the chip select pin, and when serial data transmission is being carried out, it goes to "L". Hysteresis input. Includes built-in pull-up resistor.
SCK	Serial clock input/ output	Input	When CS pin is "L", SIN serial data is taken in when SCK rises. Hysteresis input. Built-in pull-up resistor is included.
SIN	Serial data input	Input/ Output	This is the pin for serial input of data and addresses for the display control register and the display data memory. Also, serially outputs decode data according to the settings in the relevant registers (serial I/O).
AC	Auto-clear input	Input	When "L", this pin resets the internal IC circuit. Hysteresis input. Includes built-in pull-up resistor.
VDD2	Power pin	—	Please connect to +5V with the analog circuit power pin.
CVIDEO	Composite video signal output	Output	This is the output pin for composite video signals. It outputs 2VP-P composite video signals. In superimpose mode, character output etc. is superimposed on the external composite video signals from CVIN.
LECHA	Character level input	Input	This is the input pin which determines the "white" character color level in the composite video signal.
CVIN	Composite video signal input	Input	This is the input pin for external composite video signals. In superimpose mode, character output etc. is superimposed on these external composite video signals.
Vss	Earthing pin	—	Please connect to GND using circuit earthing pin.
EDO	Encode data output	Output	This is the output pin for encode data. It outputs three-valve data.
TESTB	Test pin	—	This is the pin for test. Connect this pin to GND during normal operation.
P0	Port P0 output	Output	This pin outputs the port output or BLNK1 (character background) signal.
P1	Port P1 output	Output	This pin outputs the port output or CO1(character) signal.
Vss	Earthing pin	—	Please connect to GND using circuit earthing pin (Analog side).
OSCIN	fsc input pin for synchronous signal generation	Input	This is the input pin for the sub-carrier frequency (fsc) for generating a synchronous signal. A frequency of 3.580MHz is needed for NTSC, and a frequency of 4.434MHz is needed for PAL and 3.576MHz is needed for M-PAL.
CP2	Filter output	Output	Filter output pin 2.
HOR	Horizontal synchro- nizing signal input	Input	This is the input pin for external composite video signals. This pin inputs the external video signal clamped sync-chip to 1.5V, and internally carries out synchronous separation.
VDD1	Power pin	—	Please connect to +5V with the digital circuit power pin.

BLOCK DIAGRAM

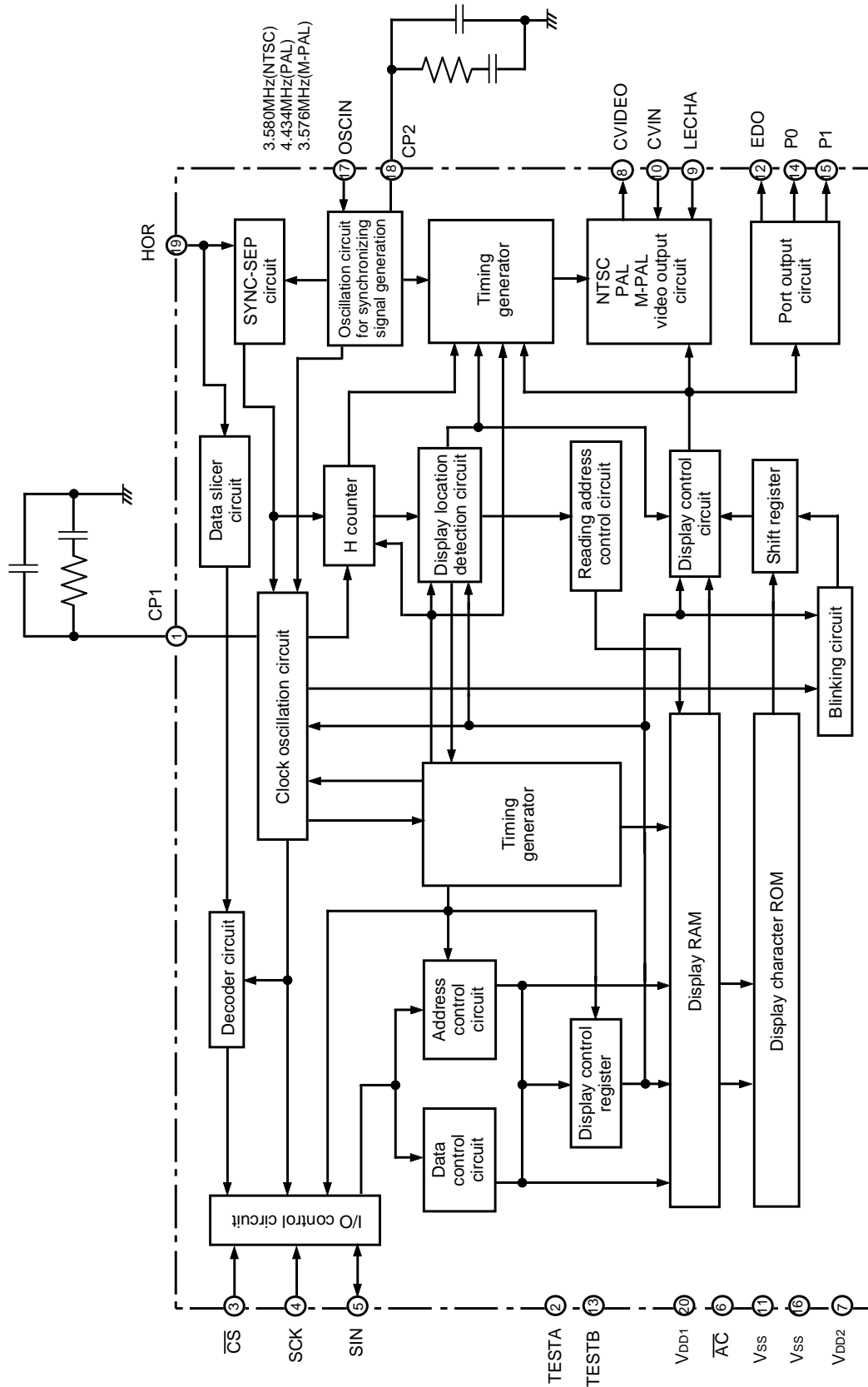

SCREEN CHARACTER and PATTERN DISPLAY CONTROLLERS

MEMORY CONSTITUTION

Address 00₁₆ to EF₁₆ are assigned to the display RAM, address F0₁₆ to F8₁₆ are assigned to the display control registers.

The internal circuit is reset and all display control registers (address F0₁₆ to F8₁₆) are set to "0" and display RAM (address 00₁₆ to EF₁₆) are RAM erased when the AC pin level is "L".

Set "0" in any of DA₇, DAD through DAF of addresses 00₁₆ through EF₁₆, and of DAE and DAF of addresses F0₁₆ through F8₁₆.

Setting the blank code "FF₁₆" as a character code is an exception. TEST_n (n : a number) is MITSUBISHI test memory, so be sure to observe the setting conditions.

Bit Address	DAF	DAE	DAD	DAC	DAB	DAA	DA9	DA8	DA7	DA6	DA5	DA4	DA3	DA2	DA1	DA0	Remarks
00 ₁₆	0	0	0	REV	BLINK	EC2	EC1	EC0	0	C6	C5	C4	C3	C2	C1	C0	Display RAM
}	⋮	⋮	⋮	Reversed character	Blinking	Encode data or character color			⋮	Character code							
	⋮	⋮	⋮			⋮	⋮	⋮	⋮	⋮	⋮	⋮	⋮	⋮	⋮		
EF ₁₆	0	0	0	REV	BLINK	EC2	EC1	EC0	0	C6	C5	C4	C3	C2	C1	C0	
F0 ₁₆	0	0	TEST25	W/R	TEST11	TEST10	DECB1	DECB0	SYSEP1	SYSEP0	SEPV1	SEPV0	PTD1	PTD0	PTC1	PTC0	Port output specify and so on
F1 ₁₆	0	0	TEST26	DVP4	DVP3	DVP2	DVP1	DVP0	HP7	HP6	HP5	HP4	HP3	HP2	HP1	HP0	Horizontal display start position and Decode position specify
F2 ₁₆	0	0	TEST27	EVP4	EVP3	EVP2	EVP1	EVP0	VP7	VP6	VP5	VP4	VP3	VP2	VP1	VP0	Vertical display start position and Encode position specify
F3 ₁₆	0	0	TEST28	TEST12	EFLD1	EFLD0	DFLD1	DFLD0	VSZ21	VSZ20	VSZ11	VSZ10	HSZ21	HSZ20	HSZ11	HSZ10	Character size and Encode Decode specify
F4 ₁₆	0	0	TEST29	TEST14	TEST13	SPACE	DSP9	DSP8	DSP7	DSP6	DSP5	DSP4	DSP3	DSP2	DSP1	DSP0	Display mode specify
F5 ₁₆	0	0	TEST30	TEST19	MB/LB	TEST17	TEST16	TEST15	EQP	PALH	MPAL	INT/NON	N/P	BLINK2	BLINK1	BLINK0	Blinking specify and so on
F6 ₁₆	0	0	TEST31	TEST2	TEST1	TEST0	LBLACK	LIN24/32	BLKHF	BB	BG	BR	LEVEL0	PHASE2	PHASE1	PHASE0	Raster color specify
F7 ₁₆	0	0	TEST32	TEST24	RGBON	TEST22	CL17/18	CBLINK	CURS7	CURS6	CURS5	CURS4	CURS3	CURS2	CURS1	CURS0	Cursor display specify
F8 ₁₆	0	0	LEVEL1	EHP4	EHP3	EHP2	EHP1	EHP0	RAMERS	DSPON	STOP1	STOPIN	SCOR	EX	BLK1	BLK0	Control display and so on

Fig. 1 Memory constitution (M35052-XXXSP/FP)

SCREEN CONSTITUTION

The screen lines and rows are determined from each address of the display RAM. The screen constitution (24 characters X 10 lines) is shown in Figure 2 the screen constitution (32 characters X 7 lines) is shown in 3.

Rows/Lines	1	2	3	4	5	6	7	8	9	10	11	12	13	14	15	16	17	18	19	20	21	22	23	24
1	00 ₁₆	01 ₁₆	02 ₁₆	03 ₁₆	04 ₁₆	05 ₁₆	06 ₁₆	07 ₁₆	08 ₁₆	09 ₁₆	0A ₁₆	0B ₁₆	0C ₁₆	0D ₁₆	0E ₁₆	0F ₁₆	10 ₁₆	11 ₁₆	12 ₁₆	13 ₁₆	14 ₁₆	15 ₁₆	16 ₁₆	17 ₁₆
2	18 ₁₆	19 ₁₆	1A ₁₆	1B ₁₆	1C ₁₆	1D ₁₆	1E ₁₆	1F ₁₆	20 ₁₆	21 ₁₆	22 ₁₆	23 ₁₆	24 ₁₆	25 ₁₆	26 ₁₆	27 ₁₆	28 ₁₆	29 ₁₆	2A ₁₆	2B ₁₆	2C ₁₆	2D ₁₆	2E ₁₆	2F ₁₆
3	30 ₁₆	31 ₁₆	32 ₁₆	33 ₁₆	34 ₁₆	35 ₁₆	36 ₁₆	37 ₁₆	38 ₁₆	39 ₁₆	3A ₁₆	3B ₁₆	3C ₁₆	3D ₁₆	3E ₁₆	3F ₁₆	40 ₁₆	41 ₁₆	42 ₁₆	43 ₁₆	44 ₁₆	45 ₁₆	46 ₁₆	47 ₁₆
4	48 ₁₆	49 ₁₆	4A ₁₆	4B ₁₆	4C ₁₆	4D ₁₆	4E ₁₆	4F ₁₆	50 ₁₆	51 ₁₆	52 ₁₆	53 ₁₆	54 ₁₆	55 ₁₆	56 ₁₆	57 ₁₆	58 ₁₆	59 ₁₆	5A ₁₆	5B ₁₆	5C ₁₆	5D ₁₆	5E ₁₆	5F ₁₆
5	60 ₁₆	61 ₁₆	62 ₁₆	63 ₁₆	64 ₁₆	65 ₁₆	66 ₁₆	67 ₁₆	68 ₁₆	69 ₁₆	6A ₁₆	6B ₁₆	6C ₁₆	6D ₁₆	6E ₁₆	6F ₁₆	70 ₁₆	71 ₁₆	72 ₁₆	73 ₁₆	74 ₁₆	75 ₁₆	76 ₁₆	77 ₁₆
6	78 ₁₆	79 ₁₆	7A ₁₆	7B ₁₆	7C ₁₆	7D ₁₆	7E ₁₆	7F ₁₆	80 ₁₆	81 ₁₆	82 ₁₆	83 ₁₆	84 ₁₆	85 ₁₆	86 ₁₆	87 ₁₆	88 ₁₆	89 ₁₆	8A ₁₆	8B ₁₆	8C ₁₆	8D ₁₆	8E ₁₆	8F ₁₆
7	90 ₁₆	91 ₁₆	92 ₁₆	93 ₁₆	94 ₁₆	95 ₁₆	96 ₁₆	97 ₁₆	98 ₁₆	99 ₁₆	9A ₁₆	9B ₁₆	9C ₁₆	9D ₁₆	9E ₁₆	9F ₁₆	A0 ₁₆	A1 ₁₆	A2 ₁₆	A3 ₁₆	A4 ₁₆	A5 ₁₆	A6 ₁₆	A7 ₁₆
8	A8 ₁₆	A9 ₁₆	AA ₁₆	AB ₁₆	AC ₁₆	AD ₁₆	AE ₁₆	AF ₁₆	B0 ₁₆	B1 ₁₆	B2 ₁₆	B3 ₁₆	B4 ₁₆	B5 ₁₆	B6 ₁₆	B7 ₁₆	B8 ₁₆	B9 ₁₆	BA ₁₆	BB ₁₆	BC ₁₆	BD ₁₆	BE ₁₆	BF ₁₆
9	C0 ₁₆	C1 ₁₆	C2 ₁₆	C3 ₁₆	C4 ₁₆	C5 ₁₆	C6 ₁₆	C7 ₁₆	C8 ₁₆	C9 ₁₆	CA ₁₆	CB ₁₆	CC ₁₆	CD ₁₆	CE ₁₆	CF ₁₆	D0 ₁₆	D1 ₁₆	D2 ₁₆	D3 ₁₆	D4 ₁₆	D5 ₁₆	D6 ₁₆	D7 ₁₆
10	D8 ₁₆	D9 ₁₆	DA ₁₆	DB ₁₆	DC ₁₆	DD ₁₆	DE ₁₆	DF ₁₆	E0 ₁₆	E1 ₁₆	E2 ₁₆	E3 ₁₆	E4 ₁₆	E5 ₁₆	E6 ₁₆	E7 ₁₆	E8 ₁₆	E9 ₁₆	EA ₁₆	EB ₁₆	EC ₁₆	ED ₁₆	EE ₁₆	EF ₁₆

Note : The hexadecimal numbers in the boxes show the display RAM address.

Fig. 2 Screen constitution (24 characters X 10 lines)

Rows/Lines	1	2	3	4	5	6	7	8	9	10	11	12	13	14	15	16	17	18	19	20	21	22	23	24	25	26	27	28	29	30	31	32
1	00 ₁₆	01 ₁₆	02 ₁₆	03 ₁₆	04 ₁₆	05 ₁₆	06 ₁₆	07 ₁₆	08 ₁₆	09 ₁₆	0A ₁₆	0B ₁₆	0C ₁₆	0D ₁₆	0E ₁₆	0F ₁₆	10 ₁₆	11 ₁₆	12 ₁₆	13 ₁₆	14 ₁₆	15 ₁₆	16 ₁₆	17 ₁₆	18 ₁₆	19 ₁₆	1A ₁₆	1B ₁₆	1C ₁₆	1D ₁₆	1E ₁₆	1F ₁₆
2	20 ₁₆	21 ₁₆	22 ₁₆	23 ₁₆	24 ₁₆	25 ₁₆	26 ₁₆	27 ₁₆	28 ₁₆	29 ₁₆	2A ₁₆	2B ₁₆	2C ₁₆	2D ₁₆	2E ₁₆	2F ₁₆	30 ₁₆	31 ₁₆	32 ₁₆	33 ₁₆	34 ₁₆	35 ₁₆	36 ₁₆	37 ₁₆	38 ₁₆	39 ₁₆	3A ₁₆	3B ₁₆	3C ₁₆	3D ₁₆	3E ₁₆	3F ₁₆
3	40 ₁₆	41 ₁₆	42 ₁₆	43 ₁₆	44 ₁₆	45 ₁₆	46 ₁₆	47 ₁₆	48 ₁₆	49 ₁₆	4A ₁₆	4B ₁₆	4C ₁₆	4D ₁₆	4E ₁₆	4F ₁₆	50 ₁₆	51 ₁₆	52 ₁₆	53 ₁₆	54 ₁₆	55 ₁₆	56 ₁₆	57 ₁₆	58 ₁₆	59 ₁₆	5A ₁₆	5B ₁₆	5C ₁₆	5D ₁₆	5E ₁₆	5F ₁₆
4	60 ₁₆	61 ₁₆	62 ₁₆	63 ₁₆	64 ₁₆	65 ₁₆	66 ₁₆	67 ₁₆	68 ₁₆	69 ₁₆	6A ₁₆	6B ₁₆	6C ₁₆	6D ₁₆	6E ₁₆	6F ₁₆	70 ₁₆	71 ₁₆	72 ₁₆	73 ₁₆	74 ₁₆	75 ₁₆	76 ₁₆	77 ₁₆	78 ₁₆	79 ₁₆	7A ₁₆	7B ₁₆	7C ₁₆	7D ₁₆	7E ₁₆	7F ₁₆
5	80 ₁₆	81 ₁₆	82 ₁₆	83 ₁₆	84 ₁₆	85 ₁₆	86 ₁₆	87 ₁₆	88 ₁₆	89 ₁₆	8A ₁₆	8B ₁₆	8C ₁₆	8D ₁₆	8E ₁₆	8F ₁₆	90 ₁₆	91 ₁₆	92 ₁₆	93 ₁₆	94 ₁₆	95 ₁₆	96 ₁₆	97 ₁₆	98 ₁₆	99 ₁₆	9A ₁₆	9B ₁₆	9C ₁₆	9D ₁₆	9E ₁₆	9F ₁₆
6	A0 ₁₆	A1 ₁₆	A2 ₁₆	A3 ₁₆	A4 ₁₆	A5 ₁₆	A6 ₁₆	A7 ₁₆	A8 ₁₆	A9 ₁₆	AA ₁₆	AB ₁₆	AC ₁₆	AD ₁₆	AE ₁₆	AF ₁₆	B0 ₁₆	B1 ₁₆	B2 ₁₆	B3 ₁₆	B4 ₁₆	B5 ₁₆	B6 ₁₆	B7 ₁₆	B8 ₁₆	B9 ₁₆	BA ₁₆	BB ₁₆	BC ₁₆	BD ₁₆	BE ₁₆	BF ₁₆
7	C0 ₁₆	C1 ₁₆	C2 ₁₆	C3 ₁₆	C4 ₁₆	C5 ₁₆	C6 ₁₆	C7 ₁₆	C8 ₁₆	C9 ₁₆	CA ₁₆	CB ₁₆	CC ₁₆	CD ₁₆	CE ₁₆	CF ₁₆	D0 ₁₆	D1 ₁₆	D2 ₁₆	D3 ₁₆	D4 ₁₆	D5 ₁₆	D6 ₁₆	D7 ₁₆	D8 ₁₆	D9 ₁₆	DA ₁₆	DB ₁₆	DC ₁₆	DD ₁₆	DE ₁₆	DF ₁₆

Note 1. The hexadecimal numbers in the boxes show the display RAM address.
 2. When 32 characters X 7 lines are displayed, set blank code "FF₁₆" to character code of addresses E0₁₆ to EF₁₆.

Fig. 3 Screen constitution (32 characters X 7 lines)

Display RAM DESCRIPTION

Display RAM Address 0016 to EF16

DA 0-C	Name	Contents		Remarks		
		Status	Function			
0	C0 (LSB)	0	Set ROM-held character code of a character needed to display.			
		①				
1	C1	0				
		①				
2	C2	0				
		①				
3	C3	0				
		①				
4	C4	0				
		①				
5	C5	0				
		①				
6	C6 (MSB)	0				
		①				
7	—	0			Set to "0" during normal operation	(Note 2)
		①			Can not be used	
8	EC0	0	When EFILD1, 0=1, 0 or 0, 1, set code of the data needed to encode.	Refer to encode function.		
		①				
9	EC1	0			When RGBON=1, set background color by character unit.	Refer to supplemental explanation (4).
		①				
A	EC2	0				
		①				
B	BLINK	0	No blinking	Refer to BLINK2 to 0 (address F516)		
		①	Blinking			
C	REV	①	Normal character			
		1	Reversed character			

Notes 1. Resetting at the $\bar{A}C$ pin RAM-erases the display RAM, and the status turns as indicated by the mark ○ around in the status column.
 2. Set to "1" only when you set a blank code.

Display control register

(1) Address F016

DA 0-D	Register	Contents			Remarks									
		Status	Function											
0	PTC0	0	P0 output (port 0)		Port output control									
		1	BLNK1 output											
1	PTC1	0	P1 output (port 1)		Refer to supplemental explanation (5).									
		1	CO1 output											
2	PTD0	0	It is negative polarity at P0 output "L", BLINK1 output.		Control the port data									
		1	It is positive polarity at P0 output "H", BLINK1 output.											
3	PTD1	0	It is negative polarity at P01 output "L", CO1 output.		Refer to supplemental explanation (5).									
		1	It is positive polarity at P01 output "H", CO1 output.											
4	SEPV0	0	It should be fixed to "0".		Specifies the vertical synchronous separation criterion									
		1	Can not be used.											
5	SEPV1	0	It should be fixed to "0".		Refer to supplemental explanation (1).									
		1	Can not be used.											
6	SYSEP0	0	<table border="1"> <tr> <td>SYSEP1</td> <td>SYSEP0</td> <td>Bias potential</td> </tr> <tr> <td>0</td> <td>0</td> <td>Can not be used.</td> </tr> <tr> <td>0</td> <td>1</td> <td>Can not be used.</td> </tr> </table>		SYSEP1	SYSEP0	Bias potential	0	0	Can not be used.	0	1	Can not be used.	Specifies the sync-bias potential
		SYSEP1	SYSEP0	Bias potential										
0	0	Can not be used.												
0	1	Can not be used.												
1	<table border="1"> <tr> <td>1</td> <td>0</td> <td>1.75μ</td> </tr> <tr> <td>1</td> <td>1</td> <td>Can not be used.</td> </tr> </table>		1	0	1.75μ	1	1	Can not be used.						
1	0	1.75μ												
1	1	Can not be used.												
7	SYSEP1	0	<table border="1"> <tr> <td>DECB1</td> <td>DECB0</td> <td>Bias potential</td> </tr> <tr> <td>0</td> <td>0</td> <td>2.35μ</td> </tr> <tr> <td>0</td> <td>1</td> <td>Can not be used.</td> </tr> </table>		DECB1	DECB0	Bias potential	0	0	2.35μ	0	1	Can not be used.	Specifies the decoding bias potential
		DECB1	DECB0	Bias potential										
0	0	2.35μ												
0	1	Can not be used.												
1	<table border="1"> <tr> <td>1</td> <td>0</td> <td>Can not be used.</td> </tr> <tr> <td>1</td> <td>1</td> <td>Can not be used.</td> </tr> </table>		1	0	Can not be used.	1	1	Can not be used.						
1	0	Can not be used.												
1	1	Can not be used.												
8	DECB0	0	<table border="1"> <tr> <td>DECB1</td> <td>DECB0</td> <td>Bias potential</td> </tr> <tr> <td>0</td> <td>0</td> <td>2.35μ</td> </tr> <tr> <td>0</td> <td>1</td> <td>Can not be used.</td> </tr> </table>		DECB1	DECB0	Bias potential	0	0	2.35μ	0	1	Can not be used.	Specifies the decoding bias potential
		DECB1	DECB0	Bias potential										
0	0	2.35μ												
0	1	Can not be used.												
1	<table border="1"> <tr> <td>1</td> <td>0</td> <td>Can not be used.</td> </tr> <tr> <td>1</td> <td>1</td> <td>Can not be used.</td> </tr> </table>		1	0	Can not be used.	1	1	Can not be used.						
1	0	Can not be used.												
1	1	Can not be used.												
9	DECB1	0	<table border="1"> <tr> <td>DECB1</td> <td>DECB0</td> <td>Bias potential</td> </tr> <tr> <td>0</td> <td>0</td> <td>2.35μ</td> </tr> <tr> <td>0</td> <td>1</td> <td>Can not be used.</td> </tr> </table>		DECB1	DECB0	Bias potential	0	0	2.35μ	0	1	Can not be used.	Specifies the decoding bias potential
		DECB1	DECB0	Bias potential										
0	0	2.35μ												
0	1	Can not be used.												
1	<table border="1"> <tr> <td>1</td> <td>0</td> <td>Can not be used.</td> </tr> <tr> <td>1</td> <td>1</td> <td>Can not be used.</td> </tr> </table>		1	0	Can not be used.	1	1	Can not be used.						
1	0	Can not be used.												
1	1	Can not be used.												
A	TEST10	0	Can not be used.											
		1	It should be fixed to "1".											
B	TEST11	0	It should be fixed to "0".											
		1	Can not be used.											
C	W/R	0	Input data from SIN pin		Control data I/O									
		1	Output data from SIN pin (Note 2)		Refer to decode data output timing.									
D	TEST25	0	It should be fixed to "0".											
		1	Can not be used.											

Notes 1. The mark 0 around the status value means the reset status by the "L" level is input to AC pin.

2. Not necessary to release after setting W/R to "1". Turn CS to "H" to switch over to input mode.

SCREEN CHARACTER and PATTERN DISPLAY CONTROLLERS

(2) Address F116

DA 0~D	Register	Contents		Remarks
		Status	Function	
0	HP0 (LSB)	0	<p>Let horizontal display start position be HS,</p> $HS = T \times \left(\sum_{n=0}^7 HPn + 6 \right)$ <p>T : The oscillation cycle of display clock</p>	<p>Set the horizontal display start position by use of HP7 through HP0. HP7 to HP0 = (00000000) to (00001111) setting is forbidden.</p> <p>It can be set this up to 240 steps in increments of one T.</p>
		1		
1	HP1	0		
		1		
2	HP2	0		
		1		
3	HP3	0		
		1		
4	HP4	0		
		1		
5	HP5	0		
		1		
6	HP6	0		
		1		
7	HP7 (MSB)	0		
		1		
8	DVP0 (LSB)	0	<p>Let the slice lines be DVS,</p> $DVS = \sum_{n=0}^4 2^n DVPn + 6$ <p>It should be fixed to "0".</p>	<p>Set the slice lines (horizontal scanning lines) under decoding by use of DVP4 through DVP0. DVP4 to DVP0 = (00000) to (00011) setting is forbidden.</p> <p>Thus, it can be defined a setting up to 26 steps covered by a range from line 10 to line 35.</p> <p>Refer to supplemental explanation (2) about slice lines (DVS).</p>
		1		
9	DVP1	0		
		1		
A	DVP2	0		
		1		
B	DVP3	0		
		1		
C	DVP4 (MSB)	0		
		1		
D	TEST26	0	Can not be used.	
		1		

SCREEN CHARACTER and PATTERN DISPLAY CONTROLLERS

(3) Address F216

DA 0~D	Register	Contents		Remarks
		Status	Function	
0	VP0 (LSB)	0	<p>Let vertical display start position be VS,</p> $HS = T \times \sum_{n=0}^7 2^n Vpn$ <p>H : The oscillation cycle of horizontal synchronous signal</p>	<p>Set the vertical display start position by use of VP7 through VP0. VP7 to VP0 = (00000000) to (00000110) setting is forbidden.</p> <p>It can be set this up to 249 steps in increments of one H.</p> <p>VP7 to VP0 = (00000000) to (00100011) setting is forbidden.</p>
		1		
1	VP1	0		
		1		
2	VP2	0		
		1		
3	VP3	0		
		1		
4	VP4	0		
		1		
5	VP5	0		
		1		
6	VP6	0		
		1		
7	VP7 (MSB)	0		
		1		
8	EVP0 (LSB)	0	<p>Let the encode lines be EVS,</p> $DVS = \sum_{n=0}^4 2^n EVpn + 6$	<p>Sets the lines (horizontal scanning lines) under encoding by use of EVP4 through EVP0. EVP4 to EVP0 = (00000) to (00011) setting is forbidden.</p> <p>Thus, it can be defined a setting up to 26 steps covered by a range from line 10 to line 35.</p> <p>Refer to supplemental explanation (2) about the encode lines (EVS).</p>
		1		
9	EVP1	0		
		1		
A	EVP2	0		
		1		
B	EVP3	0		
		1		
C	EVP4 (MSB)	0		
		1		
D	TEST27	0	It should be fixed to "0".	
		1	Can not be used.	

SCREEN CHARACTER and PATTERN DISPLAY CONTROLLERS

(4) Address F316

DA 0~D	Register	Contents			Remarks		
		Status	Function				
0	HSZ10	0	HSZ11	HSZ10	Horizontal direction size	Character size setting in the horizontal direction for the first line.	
		1	0	0			1T/dot
1	HSZ11	0	0	1	2T/dot		
		1	1	0	3T/dot		
2	HSZ20	0	0	1	4T/dot		
		1	1	1			
3	HSZ21	0	HSZ21	HSZ20	Horizontal direction size		Character size setting in the horizontal direction for the 2nd line to 10th line.
		1	0	0			
4	VSZ10	0	0	1	2T/dot		
		1	1	0	3T/dot		
5	VSZ11	0	0	1	4T/dot		
		1	1	1			
6	VSZ20	0	VSZ21	VSZ20	Vertical direction size	Character size setting in the vertical direction for the 2nd line to 10th line.	
		1	0	0			
7	VSZ21	0	0	1	2H/dot		
		1	1	0	3H/dot		
8	DFLD0	0	0	1	4H/dot		
		1	1	1			
9	DFLD1	0	DFLD1	DFLD0	Field detection		Specifies the field determination procedure in relation to the Decoding functions. Refer to supplemental explanation (2).
		1	0	0			
A	EFILD0	0	0	1	The first field		
		1	1	0	The second field		
B	EFLD1	0	0	1	Can not be used		
		1	1	1			
C	TEST12	0	It should be fixed to "0".				
		1	Can not be used.				
D	TEST28	0	It should be fixed to "0".				
		1	Can not be used.				

SCREEN CHARACTER and PATTERN DISPLAY CONTROLLERS

(5) Address F416

DA 0~D	Register	Contents		Remarks																				
		Status	Function																					
0	DSP0	0	<table border="1" style="margin-left: 20px;"> <thead> <tr> <th>BLK1</th> <th>BLK0</th> <th>DSPn= "1"</th> <th>DSPn= "0"</th> </tr> </thead> <tbody> <tr> <td>0</td> <td>0</td> <td>Matrix-outline border size</td> <td>Matrix-outline size</td> </tr> <tr> <td>0</td> <td>1</td> <td>Border size</td> <td>Character size</td> </tr> <tr> <td>1</td> <td>0</td> <td>Matrix-outline size</td> <td>Border size</td> </tr> <tr> <td>1</td> <td>1</td> <td>Character size</td> <td>Matrix-outline size</td> </tr> </tbody> </table> <p>Depends on BLK0 and BLK1 (address F816) DSPn in the generic name for DSP0 to DSP9. DSP0 to DSP9 are each controlled independently.</p>	BLK1	BLK0	DSPn= "1"	DSPn= "0"	0	0	Matrix-outline border size	Matrix-outline size	0	1	Border size	Character size	1	0	Matrix-outline size	Border size	1	1	Character size	Matrix-outline size	Set the display mode of line 1.
		BLK1		BLK0	DSPn= "1"	DSPn= "0"																		
0	0	Matrix-outline border size		Matrix-outline size																				
0	1	Border size		Character size																				
1	0	Matrix-outline size		Border size																				
1	1	Character size		Matrix-outline size																				
1	DSP1	1		Set the display mode of line 2.																				
2	DSP2	0		Set the display mode of line 3.																				
		1																						
3	DSP3	0		Set the display mode of line 4.																				
		1																						
4	DSP4	0	Set the display mode of line 5.																					
		1																						
5	DSP5	0	Set the display mode of line 6.																					
		1																						
6	DSP6	0	Set the display mode of line 7.																					
		1																						
7	DSP7	0	Set the display mode of line 8.																					
		1																						
8	DSP8	0	Set the display mode of line 9.																					
		1																						
9	DSP9	0	Set the display mode of line 10.																					
		1																						
A	SPACE	0	Normal display	Put a space line between line 2 and line 3 in displaying 32 characters.																				
		1	Put a space line between line 2 and line 3, and between line 8 and line 9.																					
B	TEST13	0	It should be fixed to "0".																					
		1	Can not be used.																					
C	TEST14	0	It should be fixed to "0".																					
		1	Can not be used.																					
D	TEST29	0	It should be fixed to "0".																					
		1	Can not be used.																					

SCREEN CHARACTER and PATTERN DISPLAY CONTROLLERS

(6) Address F516

DA 0~D	Register	Contents			Remarks															
		Status	Function																	
0	BLINK0	0	<table border="1"> <tr> <th>BLINK0</th> <th>BLINK1</th> <th>Duty</th> </tr> <tr> <td>0</td> <td>0</td> <td>Blinking off</td> </tr> <tr> <td>0</td> <td>1</td> <td>25%</td> </tr> <tr> <td>1</td> <td>0</td> <td>50%</td> </tr> <tr> <td>1</td> <td>1</td> <td>75%</td> </tr> </table>		BLINK0	BLINK1	Duty	0	0	Blinking off	0	1	25%	1	0	50%	1	1	75%	Blinking duty ratio can be altered. (Note)
		BLINK0	BLINK1	Duty																
0	0	Blinking off																		
0	1	25%																		
1	0	50%																		
1	1	75%																		
1																				
1	BLINK1	0																		
		1																		
2	BLINK2	0	Division of vertical synchronizing signal into 1/64. Cycle approximately 1 second.		Blinking cycle can be altered.															
		1	Division of vertical synchronizing signal into 1/32. Cycle approximately 0.5 second.																	
3	N/P	0	NTSC, M-PAL mode		Refer to register MPAL															
		1	PAL mode																	
4	INT/NON	0	Interlace		Scanning lines control (only in internal synchronization)															
		1	Non interlace																	
5	MPAL	0	<table border="1"> <tr> <th>N/P</th> <th>MPAL</th> <th>Synchronous mode</th> </tr> <tr> <td>0</td> <td>0</td> <td>NTSC</td> </tr> <tr> <td>0</td> <td>1</td> <td>M-PAL</td> </tr> <tr> <td>1</td> <td>0</td> <td>PAL</td> </tr> <tr> <td>1</td> <td>1</td> <td>Not available</td> </tr> </table>		N/P	MPAL	Synchronous mode	0	0	NTSC	0	1	M-PAL	1	0	PAL	1	1	Not available	Synchronizing signal is selected with this register and N/P register.
		N/P	MPAL	Synchronous mode																
0	0	NTSC																		
0	1	M-PAL																		
1	0	PAL																		
1	1	Not available																		
1																				
6	PALH	0	<table border="1"> <tr> <th>PALH</th> <th>INT/NON</th> <th>Number of scanning lines</th> </tr> <tr> <td rowspan="2">0</td> <td>0</td> <td>625H lines</td> </tr> <tr> <td>1</td> <td>626H lines</td> </tr> <tr> <td rowspan="2">1</td> <td>0</td> <td>627H lines</td> </tr> <tr> <td>1</td> <td>628H lines</td> </tr> </table>		PALH	INT/NON	Number of scanning lines	0	0	625H lines	1	626H lines	1	0	627H lines	1	628H lines	It should be fixed to "0" at NTSC		
		PALH	INT/NON	Number of scanning lines																
0	0	625H lines																		
	1	626H lines																		
1	0	627H lines																		
	1	628H lines																		
1																				
7	EQP	0	Not include the equivalent pulse.		Effective only at non-interlace															
		1	Include the equivalent pulse.																	
8	TEST15	0	It should be fixed to "0".																	
		1	Can not be used.																	
9	TEST16	0	It should be fixed to "0".																	
		1	Can not be used.																	
A	TEST17	0	It should be fixed to "0".																	
		1	Can not be used.																	
B	MB/LB	0	Output from MSB side		Setting the decode data output form															
		1	Output from LSB side																	
C	TEST19	0	It should be fixed to "0".																	
		1	Can not be used.																	
D	TEST30	0	It should be fixed to "0".																	
		1	Can not be used.																	

Note. To flash a character, set 1 to DAB (the flash bit) of the display RAM.

SCREEN CHARACTER and PATTERN DISPLAY CONTROLLERS

(7) Address F616

DA 0~D	Register	Contents				Remarks																																				
		Status	Function																																							
0	PHASE0	①	<table border="1"> <thead> <tr> <th>PHASE2</th> <th>PHASE1</th> <th>PHASE0</th> <th>Raster</th> </tr> </thead> <tbody> <tr> <td>0</td> <td>0</td> <td>0</td> <td>Black</td> </tr> <tr> <td>0</td> <td>0</td> <td>1</td> <td>Red</td> </tr> <tr> <td>0</td> <td>1</td> <td>0</td> <td>Green</td> </tr> <tr> <td>0</td> <td>1</td> <td>1</td> <td>Yellow</td> </tr> <tr> <td>1</td> <td>0</td> <td>0</td> <td>Blue</td> </tr> <tr> <td>1</td> <td>0</td> <td>1</td> <td>Magenta</td> </tr> <tr> <td>1</td> <td>1</td> <td>0</td> <td>Cyan</td> </tr> <tr> <td>1</td> <td>1</td> <td>1</td> <td>White</td> </tr> </tbody> </table>			PHASE2	PHASE1	PHASE0	Raster	0	0	0	Black	0	0	1	Red	0	1	0	Green	0	1	1	Yellow	1	0	0	Blue	1	0	1	Magenta	1	1	0	Cyan	1	1	1	White	Raster color setting Refer to supplemental explanation (3) about video signal level
		PHASE2				PHASE1	PHASE0	Raster																																		
0	0	0				Black																																				
0	0	1				Red																																				
0	1	0				Green																																				
0	1	1				Yellow																																				
1	0	0				Blue																																				
1	0	1				Magenta																																				
1	1	0	Cyan																																							
1	1	1	White																																							
1	1																																									
1	PHASE1	①																																								
		1																																								
2	PHASE2	①																																								
		1																																								
3	LEVEL0	①	Internal bias off			Generates bias potential for composite video signals																																				
		1	Internal bias on																																							
4	BR	①	<table border="1"> <thead> <tr> <th>BB</th> <th>BG</th> <th>BR</th> <th>Character back-ground color</th> </tr> </thead> <tbody> <tr> <td>0</td> <td>0</td> <td>0</td> <td>Black</td> </tr> <tr> <td>0</td> <td>0</td> <td>1</td> <td>Red</td> </tr> <tr> <td>0</td> <td>1</td> <td>0</td> <td>Green</td> </tr> <tr> <td>0</td> <td>1</td> <td>1</td> <td>Yellow</td> </tr> <tr> <td>1</td> <td>0</td> <td>0</td> <td>Blue</td> </tr> <tr> <td>1</td> <td>0</td> <td>1</td> <td>Magenta</td> </tr> <tr> <td>1</td> <td>1</td> <td>0</td> <td>Cyan</td> </tr> <tr> <td>1</td> <td>1</td> <td>1</td> <td>White</td> </tr> </tbody> </table>			BB	BG	BR	Character back-ground color	0	0	0	Black	0	0	1	Red	0	1	0	Green	0	1	1	Yellow	1	0	0	Blue	1	0	1	Magenta	1	1	0	Cyan	1	1	1	White	Character background color setting. Refer to supplemental explanation (3) about video signal level
		BB				BG	BR	Character back-ground color																																		
0	0	0				Black																																				
0	0	1				Red																																				
0	1	0				Green																																				
0	1	1				Yellow																																				
1	0	0				Blue																																				
1	0	1				Magenta																																				
1	1	0				Cyan																																				
1	1	1				White																																				
1	1																																									
5	BG	①																																								
		1																																								
6	BB	①																																								
		1																																								
7	BLKHF	①	The halftone displaying "OFF" in superimpose			This register is available in the superimpose displaying only. (Note)																																				
		1	The halftone displaying "ON" in superimpose																																							
8	LIN $\overline{24}$ /32	①	24 characters X 10 lines display			"1" setting is forbidden under encoding.																																				
		1	32 characters X 7 lines display																																							
9	LBLACK	①	Blanking level I 2.3V			Set a blackness level																																				
		1	Blanking level II 2.1V																																							
A	TEST0	①	It should be fixed to "0".																																							
		1	Can not be used.																																							
B	TEST1	①	It should be fixed to "0".																																							
		1	Can not be used.																																							
C	TEST2	①	It should be fixed to "0".																																							
		1	Can not be used.																																							
D	TEST31	①	Can not be used.																																							
		1	It should to be fixed to "1".																																							

Note. It is necessary to input the external composite video signal to the CVIN pin, and externally connect a 100 to 200Ω register in series.

SCREEN CHARACTER and PATTERN DISPLAY CONTROLLERS

(8) Address F716

DA 0~D	Register	Contents		Remarks
		Status	Function	
0	CUR0	0	Let cursor displaying address be CURS, CURS = T x $\sum_{n=0}^7 2^n \text{CURn}$	Set the cursor displaying address by use of CUR7 through CUR0. CUR7 to CUR0 (11110000) setting is forbidden under 24 characters display. CUR7 to CUR0 (11100000) setting is forbidden under 32 characters display. Set CUR7 to CUR0 = (11111111) under cursor is not be displayed. The cursor displaying address (CURS) is correspond to display construction.
		1		
1	CUR1	0		
		1		
2	CUR2	0		
		1		
3	CUR3	0		
		1		
4	CUR4	0		
		1		
5	CUR5	0		
		1		
6	CUR6	0		
		1		
7	CUR7	0		
		1		
8	CBLINK	0	No blinking	The cursor blinking setting
		1	Blinking	
9	CL17/18	0	Cursor displaying at the 17th dot by vertical direction.	Refer to character construction.
		1	Cursor displaying at the 18th dot by vertical direction.	
A	TEST22	0	It should be fixed to "0".	
		1	Can not be used.	
B	RGBON	0	Normal	Refer to supplemental explanation (4).
		1	Character background coloring	
C	TEST24	0	It should be fixed to "0".	
		1	Can not be used.	
D	TEST32	0	It should be fixed to "0".	
		1	Can not be used.	

SCREEN CHARACTER and PATTERN DISPLAY CONTROLLERS

(9) Address F816

DA 0~D	Register	Contents				Remarks																				
		Status	Function																							
0	BLK0	0	<table border="1"> <tr> <td>BLK1</td> <td>BLK0</td> <td>DSPn= "1"</td> <td>DSPn= "0"</td> </tr> <tr> <td>0</td> <td>0</td> <td>Matrix-outline border size</td> <td>Matrix-outline size</td> </tr> <tr> <td>0</td> <td>1</td> <td>Border size</td> <td>Character size</td> </tr> <tr> <td>1</td> <td>0</td> <td>Matrix-outline size</td> <td>Border size</td> </tr> <tr> <td>1</td> <td>1</td> <td>Character size</td> <td>Matrix-outline size</td> </tr> </table>				BLK1	BLK0	DSPn= "1"	DSPn= "0"	0	0	Matrix-outline border size	Matrix-outline size	0	1	Border size	Character size	1	0	Matrix-outline size	Border size	1	1	Character size	Matrix-outline size
		BLK1					BLK0	DSPn= "1"	DSPn= "0"																	
0	0	Matrix-outline border size					Matrix-outline size																			
0	1	Border size					Character size																			
1	0	Matrix-outline size					Border size																			
1	1	Character size					Matrix-outline size																			
1																										
1	BLK1	0																								
		1																								
2	EX	0	External synchronization			Synchronizing signal switching (Note1)																				
		1	Internal synchronization																							
3	SCOR	0	Superimpose monotone display			"1" setting is forbidden at internal synchronous or PAL, M-PAL mode displaying.																				
		1	Superimpose coloring display (only NTSC)																							
4	STOPIN	0	fsc input mode			OSCIN oscillation control																				
		1	Can not be used.																							
5	STOP1	0	Oscillation VCO for display			Control oscillation VCO for display																				
		1	Stop oscillation VCO for display																							
6	DSPON	0	Display OFF																							
		1	Display ON																							
7	RAMERS	0	RAM not erased			This register does not exist (Note 3).																				
		1	RAM erased																							
8	EHP0	0	Let encode data programming start position be EHS, $EHS = T \times \sum_{n=0}^4 2^n EHPn + 6$			Set encode start position by use of EHP4 through EHP0. EHP4 to EHP0 = (00000) to (01111) is setting forbidden. Refer to encode function (3)																				
		1																								
9	EHP1	0																								
		1																								
A	EHP2	0																								
		1																								
B	EHP3	0																								
		1																								
C	EHP4	0																								
		1																								
D	LEVEL1	0	Internal bias OFF			Generates bias potential for decoding and synchronous separation.																				
		1	Internal bias ON																							

- Notes 1.** In dealing with the internal synchronization, cut off external video signals outside the IC. The leakage of external input video signals can be avoided.
- 2.** In displaying color superimposition, enter into the OSCIN pin the fsc signal that phase-synchronizes with the color burst of the composite video signals (input to the CVIN pin).
- 3.** Erases all the display RAM. The character code turns to blank-FF16, the encode data bit and the blinking bit turn to "1" respectively, and reversed character bit turns to "0".

Supplemental explanation about display control register

(1) How to effect synchronous separation from composite video signals

Synchronous separation is effected as follows depending on the width of L-level of the vertical synchronous period.

1. Less than 8.4 μs Not to be determined to be a vertical synchronous signal.
2. Equal to or higher than 8.4 μs but less than 15.6 μs When two clocks continue, if take place, it is "L" period is determined to be a vertical synchronization signal.
3. Equal to or higher than 15.6 μs It is "L" period is determined to be a vertical synchronous signal with no condition.

The determination is made at the timing indicated by V in Fig.3 either in case 2 or in case 3.

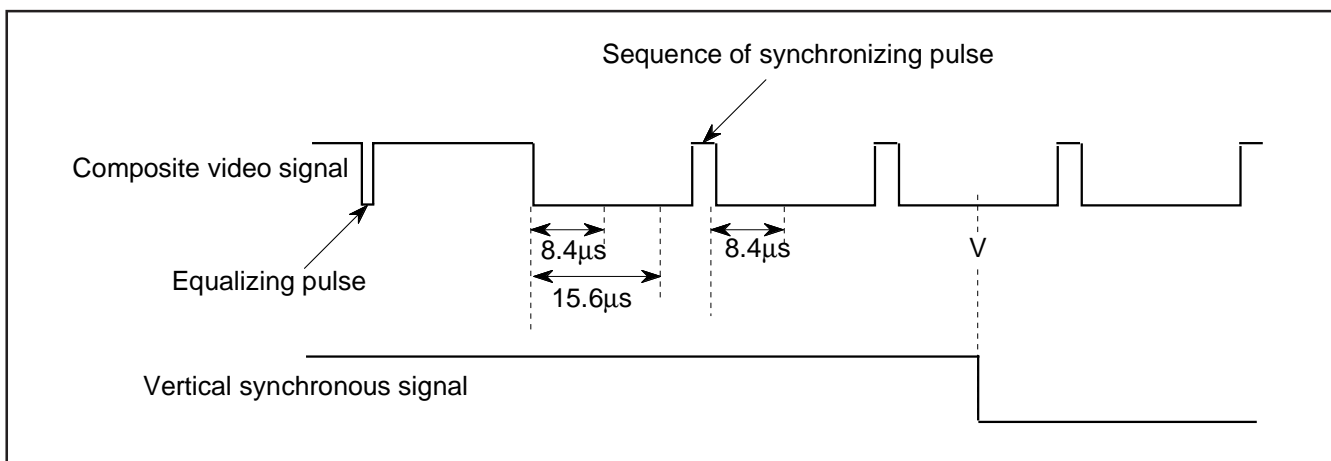

Fig. 4 The method of synchronous separation from composite video signal.

(2) Field definition

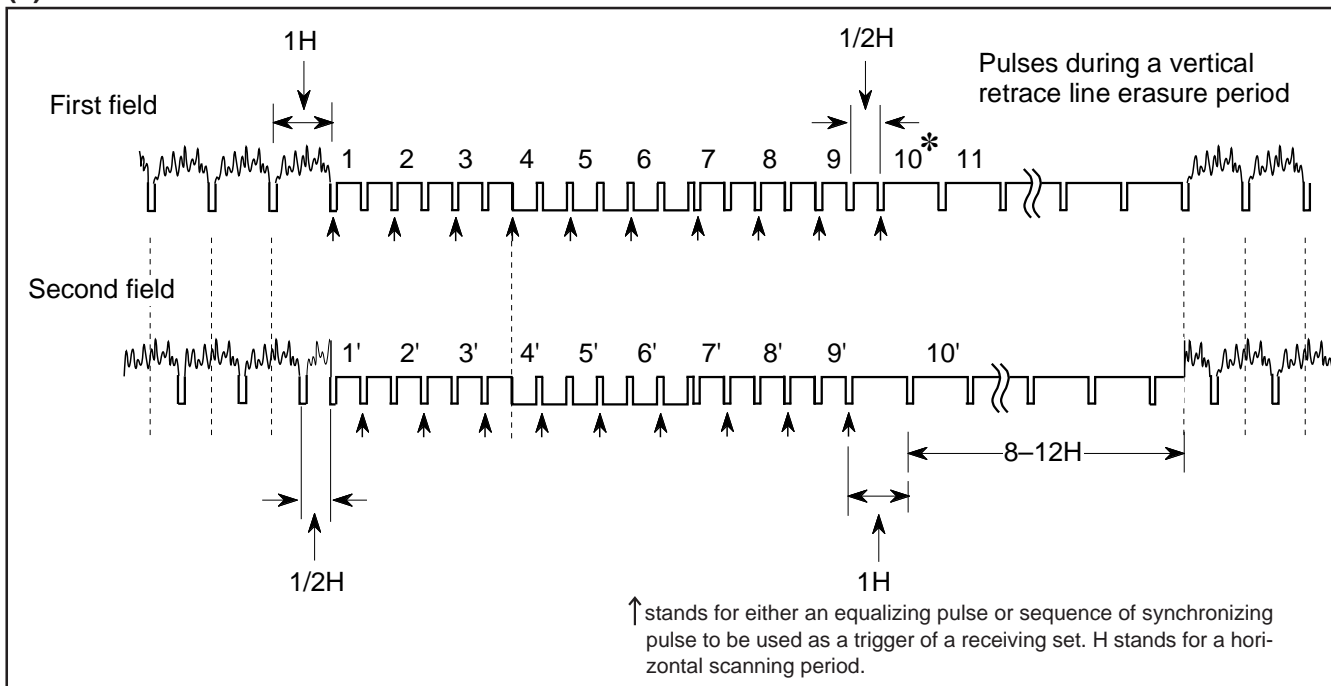

Fig. 5 Field definition

*A horizontal scanning line number corresponds to slice lines DVP4 through DVP0 (address F116) and to encode lines EVP4 through EVP0 (address F216).

(3) Video signal level

VDD : 5.0V, Ta : 25°C

Color	Phase angle (rad)		Brightness level (V)			Amplitude ratio (to color burst)		
	NTSC method	PAL, M-PAL method	Min.	Typ.	Max.	Min.	Typ.	Max.
Sync-chip	–	–	1.3	1.5	1.7	–	–	–
Pedestal	–	–	1.9	2.1	2.3	–	–	–
Color burst	0	$\pm 4\pi/16$	1.9	2.1	2.3	–	1.0	–
Black	–	–	2.1	2.3	2.5	–	–	–
Red	$7\pi/16 \pm 2\pi/16$	$\pm 7\pi/16 \pm 2\pi/16$	2.3	2.5	2.7	1.5	3.0	4.5
Green	$27\pi/16 \pm 2\pi/16$	$\mp 5\pi/16 \pm 2\pi/16$	2.7	2.9	3.1	1.4	2.8	4.2
Yellow	$\pi/16 \pm 2\pi/16$	$\pm \pi/16 \pm 2\pi/16$	3.1	3.3	3.5	1.0	2.0	3.0
Blue	$17\pi/16 \pm 2\pi/16$	$\mp 15\pi/16 \pm 2\pi/16$	2.0	2.2	2.4	1.0	2.0	3.0
Magenta	$11\pi/16 \pm 2\pi/16$	$\pm 11\pi/16 \pm 2\pi/16$	2.5	2.7	2.9	1.4	2.8	4.2
Cyan	$23\pi/16 \pm 2\pi/16$	$\mp 9\pi/16 \pm 2\pi/16$	2.9	3.1	3.3	1.5	3.0	4.5
White	–	–	3.1	3.3	3.5	–	–	–

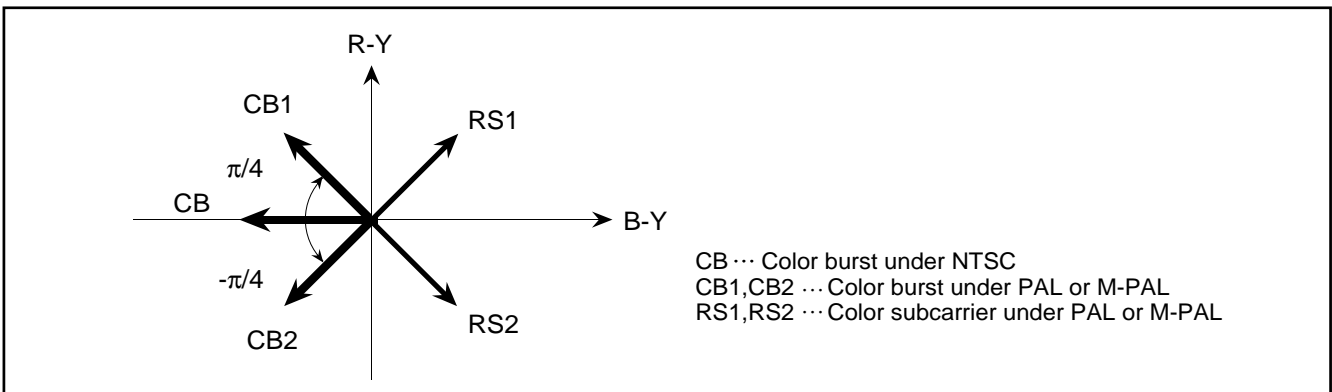

Fig. 6 Bector phases

(4) Setting RGBON (address F716)

- a) When encode is off ... EFILD1, 0 (address F316) = 0, 0
 Encode setting ... Not effected
 RGBON = "0" Sets background colors depending on BB, BG, and BR (address F616), screen by screen.
 RGBON = "1" Sets background colors depending on EC2 to EC0 (address 0016 to EF16), character by character. The color setting is shown below.
- b) When encode is on ... EFILD1, 0 (address F316) = 0, 1 or 1, 0
 Encode setting ... Sets encode data depending on EC2 through EC0. (Refer to the encode functions for details.)
 RGBON = "0" Sets background colors depending on BB, BG and BR (address F616) screen by screen.
 RGBON = "1" This setting can not be used.
 (When encode is on, setting RGBON to "1" results in setting both encode data and background colors depending on the same memory (EC2 through EC0), so this setting can not be used.

Color Setting

EC2	EC1	EC0	Color
0	0	0	Black
0	0	1	Red
0	1	0	Green
0	1	1	Yellow
1	0	0	Blue
1	0	1	Magenta
1	1	0	Cyan
1	1	1	White

(5) Port output and BLNK1, CO1 output

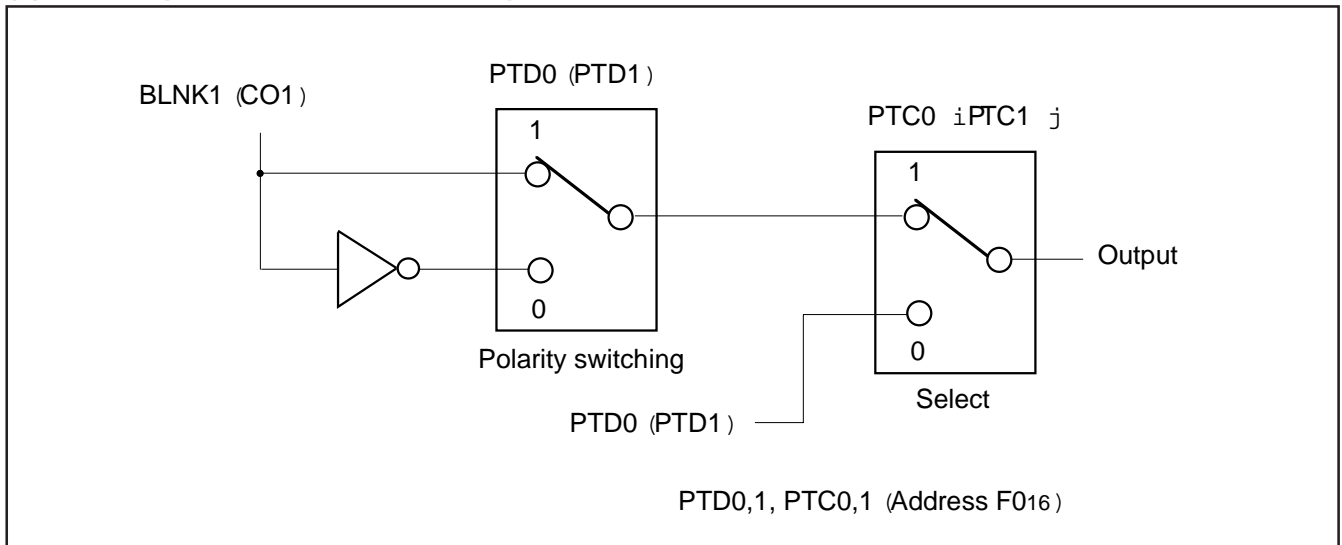

Fig. 7 Example of port control

(6) Setting conditions for oscillating or stopping the display clock

	at display clock operating	at display clock stop
STOP1	0	1
DSPON	1	0
CS pin	L	H

STOP1, DSPON (Address F816)

(7) Setting condition at LEVEL0,1

	Operation state (Character display)		Now-working condition (no characters are displayed)
	Internal synchronous	External synchronous	
LEVEL0	1	1	0
LEVEL1	0	1	0

LEVEL0 (address F616), LEVEL1 (address F816)

DISPLAY FORMS

M35052-XXXSP/FP has the following four display forms as the blanking function, when CO1 and BLNK1 are output.

- (1) Character size : Blanking same as the character size.
- (2) Border size : Blanking the background as a size from character.
- (3) Matrix-outline size: Blanking the background as a size from all character font size.
- (4) Matrix-outline border size : Blanking the background as a size from all character font size.
Border display.

This display format allows each line to be controlled independently, so that two kinds of display formats can be combined on the same screen.

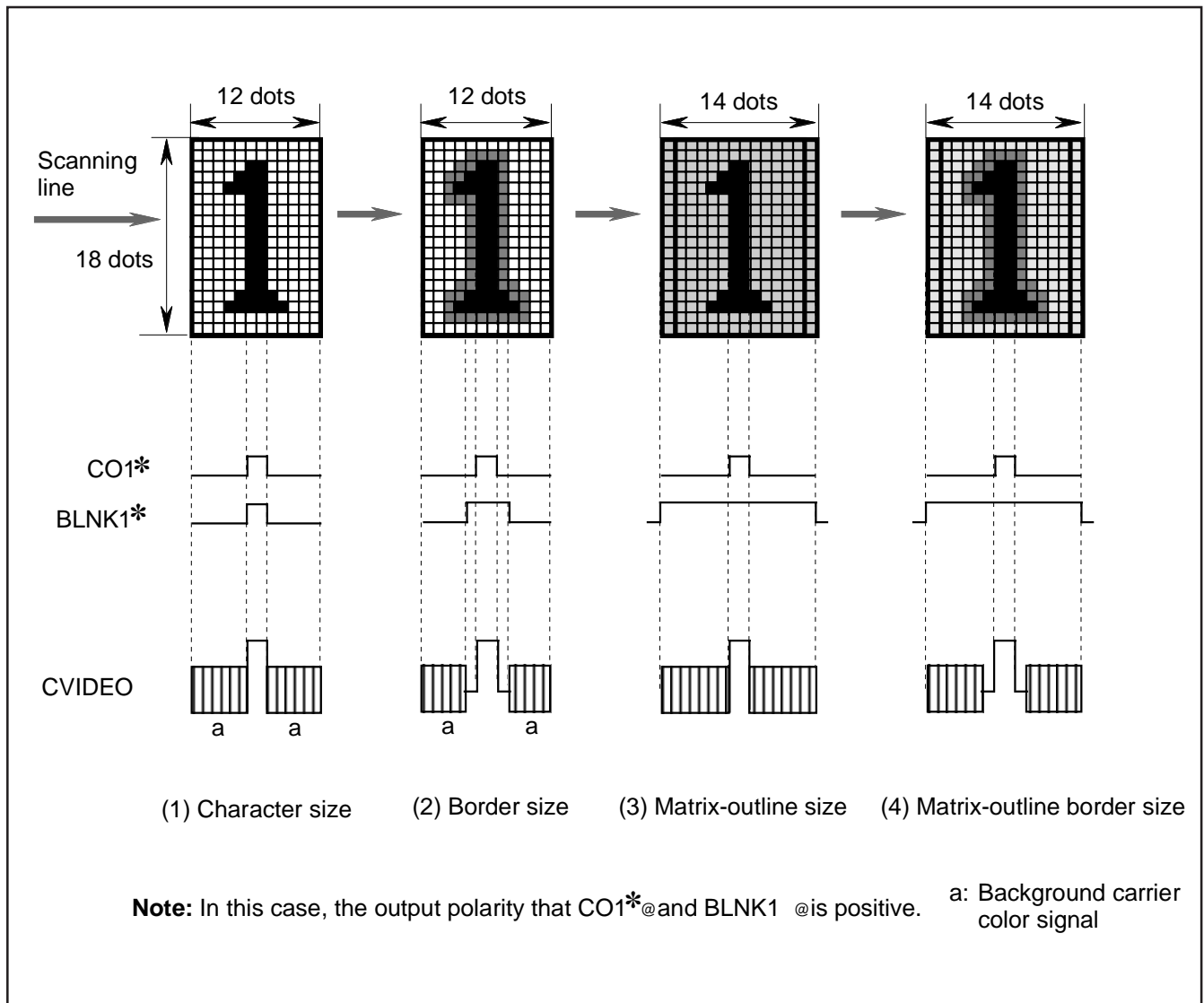

Fig. 8 Display forms at each display mode

DATA INPUT EXAMPLE

Data of display RAM and display control registers can be set by then serial input function. Example of data setting is shown in Figure 9.

Owing to automatic address increment, not necessary to enter addresses for the second and subsequent data.

In automatically, the next of address F8₁₆ is assigned to address 00₁₆.

Fig. 9 shows an example of data serially entered.

	DA F	DA E	DA D	DA C	DA B	DA A	DA 9	DA 8	DA 7	DA 6	DA 5	DA 4	DA 3	DA 2	DA 1	DA 0	Remarks
Address (F8 ₁₆)	0	0	0	0	0	0	0	0	1	1	1	1	1	0	0	0	Specify address
Data (F8 ₁₆)	0	0	0	0	0	0	0	0	0	0	0	0	0	0	0	0	Display OFF
	0	0	0	REV	BLINK	EC2	EC1	EC0	0	C6	C5	C4	C3	C2	C1	C0	Specify address display RAM 0 to EF ₁₆ .
Data (01 ₁₆)	0	0	0	REV	BLINK	EC2	EC1	EC0	0	C6	C5	C4	C3	C2	C1	C0	
}	}								}								
Data (EE ₁₆)	0	0	0	REV	BLINK	EC2	EC1	EC0	0	C6	C5	C4	C3	C2	C1	C0	
Data (EF ₁₆)	0	0	0	REV	BLINK	EC2	EC1	EC0	0	C6	C5	C4	C3	C2	C1	C0	Specify address register F0 ₁₆ to F7 ₁₆ .
Data (F0 ₁₆)	0	0	0	W/R	0	1	0	0	1	0	0	0	PTD 1	PTD 0	PTC 1	PTC 0	
Data (F1 ₁₆)	0	0	0	DVP 4	DVP 3	DVP 2	DVP 1	DVP 0	HP 7	HP 6	HP 5	HP 4	HP 3	HP 2	HP 1	HP 0	
Data (F2 ₁₆)	0	0	0	EVP 4	EVP 3	EVP 2	EVP 1	EVP 0	VP 7	VP 6	VP 5	VP 4	VP 3	VP 2	VP 1	VP 0	
Data (F3 ₁₆)	0	0	0	0	EFLD 1	EFLD 0	DFLD 1	DFLD 0	VSZ 21	VSZ 20	VSZ 11	VSZ 10	HSZ 21	HSZ 20	HSZ 11	HSZ 10	
Data (F4 ₁₆)	0	0	0	0	0	SPACE	DSP 9	DSP 8	DSP 7	DSP 6	DSP 5	DSP 4	DSP 3	DSP 2	DSP 1	DSP 0	
Data (F5 ₁₆)	0	0	0	0	MB/LB	0	0	0	EQP	PALH	MPAL	INT /NON	N/P	BLINK 2	BLINK 1	BLINK 0	
Data (F6 ₁₆)	0	0	1	0	0	0	LBLACK	LIN 24/32	BLKHF	BB	BG	BR	LEVEL 0	PHASE 2	PHASE 1	PHASE 0	
Data (F7 ₁₆)	0	0	0	0	RGBON	0	CL 17/18	CBLINK	CURS 7	CURS 6	CURS 5	CURS 4	CURS 3	CURS 2	CURS 1	CURS 0	
Data (F8 ₁₆)	0	0	LEVEL 1	EHP 4	EHP 3	EHP 2	EHP 1	EHP 0	RAM ERS	DSPON	STOP 1	STOP IN	SCOR	EX	BLK 1	BLK 0	

Fig. 9 Example of data setting serial input function

SERIAL DATA INPUT TIMING

- (1) The address consists of 16 bits.
- (2) The data consists of 16 bits.
- (3) The 16 bits in the SCK after the CS signal has fallen are the address, and for succeeding input data, the address is incremented every 16 bits.

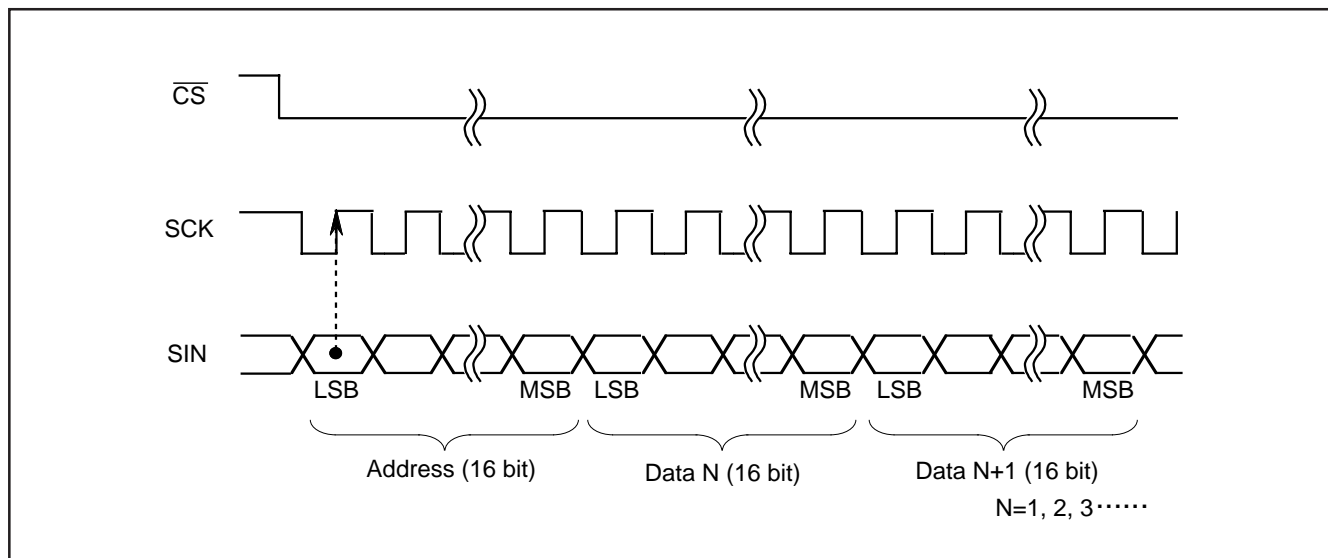

Fig. 10 Serial input timing

Output timing of decode data

- (1) Setting "1" in the $\overline{W/R}$ register activates output mode.
- (2) Outputs decode data in 16 clocks of the SCK after switching over to output mode. (Don't enter the SCK for more than 16 clocks.)
- (3) Raising the \overline{CS} signal deactivates output mode. (To switch over to input mode, cause \overline{CS} to fall.)
- (4) If no data are present, or if data have already been read, 0000₁₆ is output.

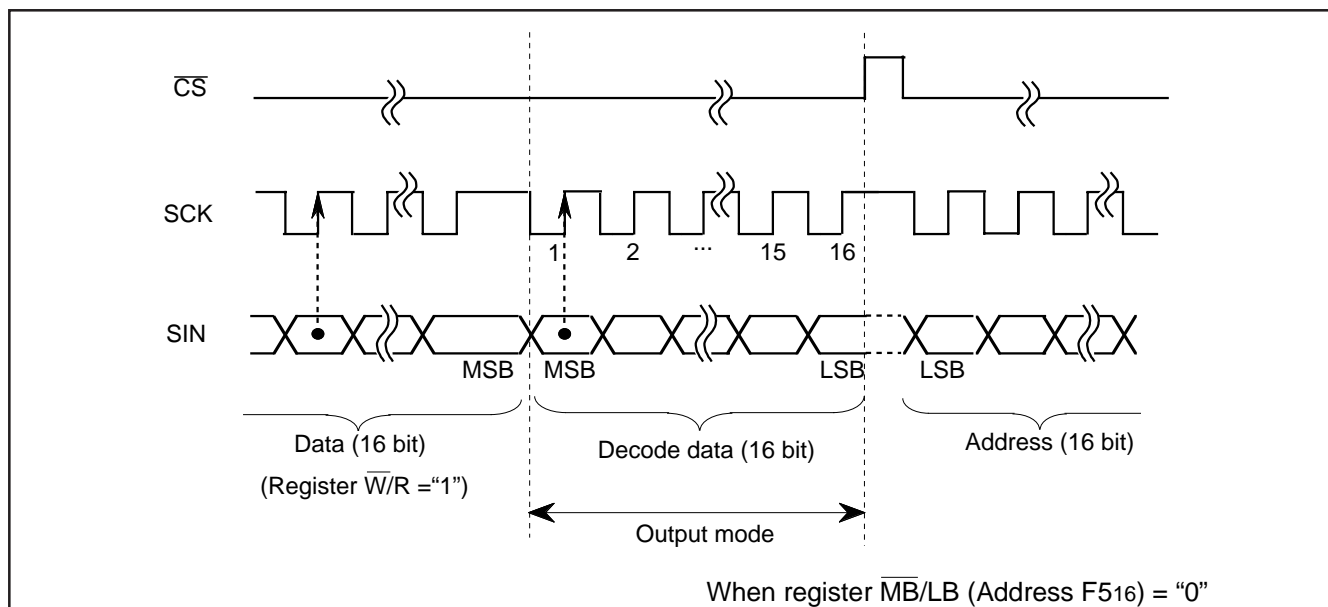
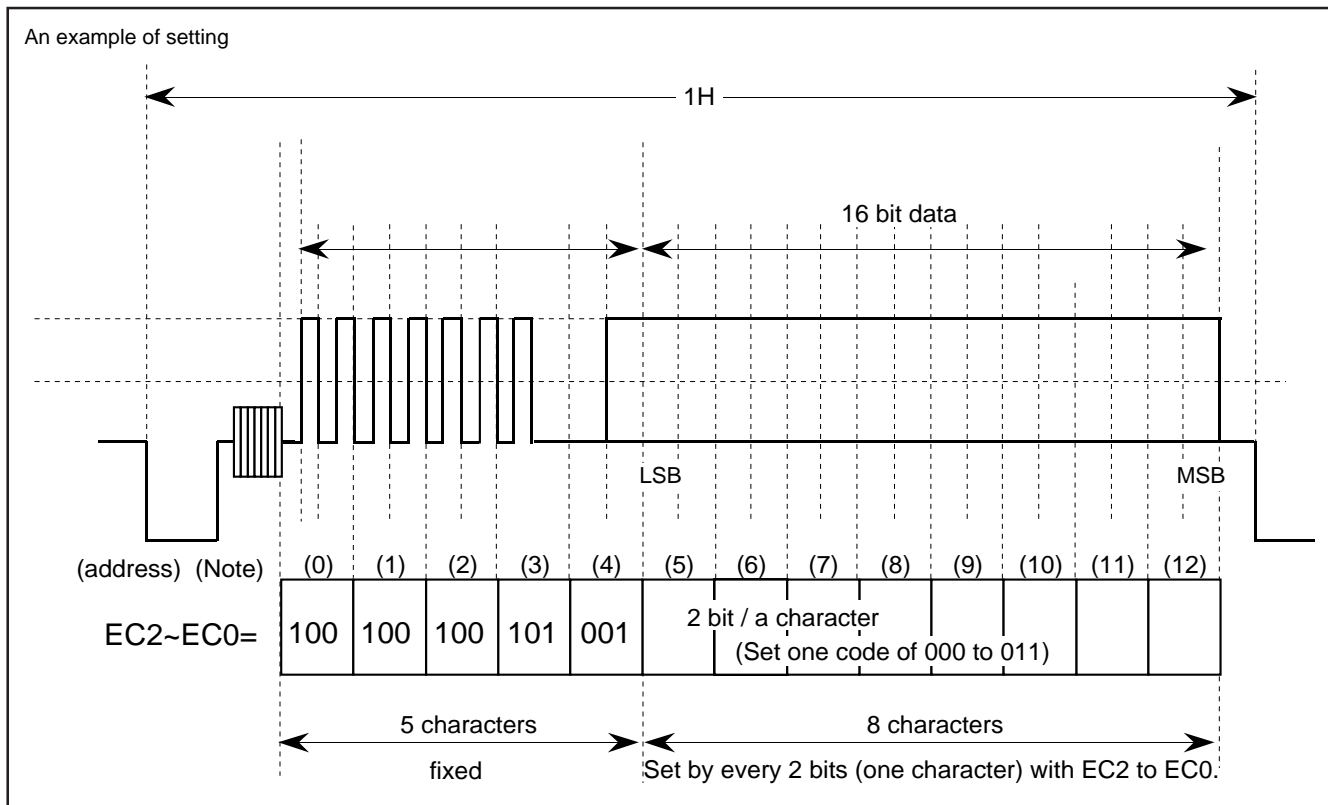

Fig. 11 Decode data output timing

Encode functions (effective for NTSC only)

(1) Setting encode data

Setting data code (000 – 111) in EC0 through EC2 (bits DA8 through DAA) of the display RAM (addresses 0 through EF16) encodes. A sample setting and data code are shown below.



A suite of data code (000 – 111) for encoding to be set in EC2 through EC0 are assigned as given below.

EC2	EC1	EC0	Data
0	0	0	L L
0	0	1	L H
0	1	0	H L
0	1	1	H H
1	0	0	LHLH
1	0	1	LHL
1	1	0	LHL
1	1	1	LHL

18 dots

12 dots

(The oscillation frequency when encoding: 3 MHz*
 1 clock cycle: 0.333μs
 1 character (12 dots): 3.996μs
 2 bits/1 character: 3.996μs
 1 bit: 1.998μs)

*..... 192 X fH (horizontal synchronous frequency)
 for fH = 15.625 kHz

Can not be used

No encoding

Note: Refer to the next page about address setting.

Fig. 12 An example of data code setting

(2) Setting addresses

Set encode data in EC0 through EC2 of addresses (that correspond to an extent from the first character to the thirteenth character in each line as appearing on the screen.) Set "111" to EC2 through EC0 of all the addresses in which you set no encode data.

Screen

	The first character												The 13th character						The 24th character					
line 1	00 ₁₆	01 ₁₆	02 ₁₆	03 ₁₆	04 ₁₆	05 ₁₆	06 ₁₆	07 ₁₆	08 ₁₆	09 ₁₆	0A ₁₆	0B ₁₆	0C ₁₆	0D ₁₆	0E ₁₆	0F ₁₆	10 ₁₆	11 ₁₆	12 ₁₆	13 ₁₆	14 ₁₆	15 ₁₆	16 ₁₆	17 ₁₆
line 2	18 ₁₆	19 ₁₆	1A ₁₆	1B ₁₆	1C ₁₆	1D ₁₆	1E ₁₆	1F ₁₆	20 ₁₆	21 ₁₆	22 ₁₆	23 ₁₆	24 ₁₆	25 ₁₆	26 ₁₆	27 ₁₆	28 ₁₆	29 ₁₆	2A ₁₆	2B ₁₆	2C ₁₆	2D ₁₆	2E ₁₆	2F ₁₆
line 3	30 ₁₆	31 ₁₆	32 ₁₆	33 ₁₆	34 ₁₆	35 ₁₆	36 ₁₆	37 ₁₆	38 ₁₆	39 ₁₆	3A ₁₆	3B ₁₆	3C ₁₆	3D ₁₆	3E ₁₆	3F ₁₆	40 ₁₆	41 ₁₆	42 ₁₆	43 ₁₆	44 ₁₆	45 ₁₆	46 ₁₆	47 ₁₆
line 4	48 ₁₆	49 ₁₆	4A ₁₆	4B ₁₆	4C ₁₆	4D ₁₆	4E ₁₆	4F ₁₆	50 ₁₆	51 ₁₆	52 ₁₆	53 ₁₆	54 ₁₆	55 ₁₆	56 ₁₆	57 ₁₆	58 ₁₆	59 ₁₆	5A ₁₆	5B ₁₆	5C ₁₆	5D ₁₆	5E ₁₆	5F ₁₆
line 5	60 ₁₆	61 ₁₆	62 ₁₆	63 ₁₆	64 ₁₆	65 ₁₆	66 ₁₆	67 ₁₆	68 ₁₆	69 ₁₆	6A ₁₆	6B ₁₆	6C ₁₆	6D ₁₆	6E ₁₆	6F ₁₆	70 ₁₆	71 ₁₆	72 ₁₆	73 ₁₆	74 ₁₆	75 ₁₆	76 ₁₆	77 ₁₆
line 6	78 ₁₆	79 ₁₆	7A ₁₆	7B ₁₆	7C ₁₆	7D ₁₆	7E ₁₆	7F ₁₆	80 ₁₆	81 ₁₆	82 ₁₆	83 ₁₆	84 ₁₆	85 ₁₆	86 ₁₆	87 ₁₆	88 ₁₆	89 ₁₆	8A ₁₆	8B ₁₆	8C ₁₆	8D ₁₆	8E ₁₆	8F ₁₆
line 7	90 ₁₆	91 ₁₆	92 ₁₆	93 ₁₆	94 ₁₆	95 ₁₆	96 ₁₆	97 ₁₆	98 ₁₆	99 ₁₆	9A ₁₆	9B ₁₆	9C ₁₆	9D ₁₆	9E ₁₆	9F ₁₆	A0 ₁₆	A1 ₁₆	A2 ₁₆	A3 ₁₆	A4 ₁₆	A5 ₁₆	A6 ₁₆	A7 ₁₆
line 8	A8 ₁₆	A9 ₁₆	AA ₁₆	AB ₁₆	AC ₁₆	AD ₁₆	AE ₁₆	AF ₁₆	B0 ₁₆	B1 ₁₆	B2 ₁₆	B3 ₁₆	B4 ₁₆	B5 ₁₆	B6 ₁₆	B7 ₁₆	B8 ₁₆	B9 ₁₆	BA ₁₆	BB ₁₆	BC ₁₆	BD ₁₆	BE ₁₆	BF ₁₆
line 9	C0 ₁₆	C1 ₁₆	C2 ₁₆	C3 ₁₆	C4 ₁₆	C5 ₁₆	C6 ₁₆	C7 ₁₆	C8 ₁₆	C9 ₁₆	CA ₁₆	CB ₁₆	CC ₁₆	CD ₁₆	CE ₁₆	CF ₁₆	D0 ₁₆	D1 ₁₆	D2 ₁₆	D3 ₁₆	D4 ₁₆	D5 ₁₆	D6 ₁₆	D7 ₁₆
line 10	D8 ₁₆	D9 ₁₆	DA ₁₆	DB ₁₆	DC ₁₆	DD ₁₆	DE ₁₆	DF ₁₆	E0 ₁₆	E1 ₁₆	E2 ₁₆	E3 ₁₆	E4 ₁₆	E5 ₁₆	E6 ₁₆	E7 ₁₆	E8 ₁₆	E9 ₁₆	EA ₁₆	EB ₁₆	EC ₁₆	ED ₁₆	EE ₁₆	EF ₁₆

Using area for encode data setting

Useless area

Start setting data from the first line. Data set in the lines specified by registers EVP0 through EVP3 (address F2₁₆) will be encoded.
 Setting data in the second and subsequent lines, it is possible to set encode data to ten consecutive lines from those specified by registers EVP0 to EVP2.
 Similarly to encode line N specified by registers EVP0 through EVP2, extending encode lines to line N-1 and to line N+1, it is possible to read encode data more certainly.

Fig.13 Display monitor

(3) Encode data output

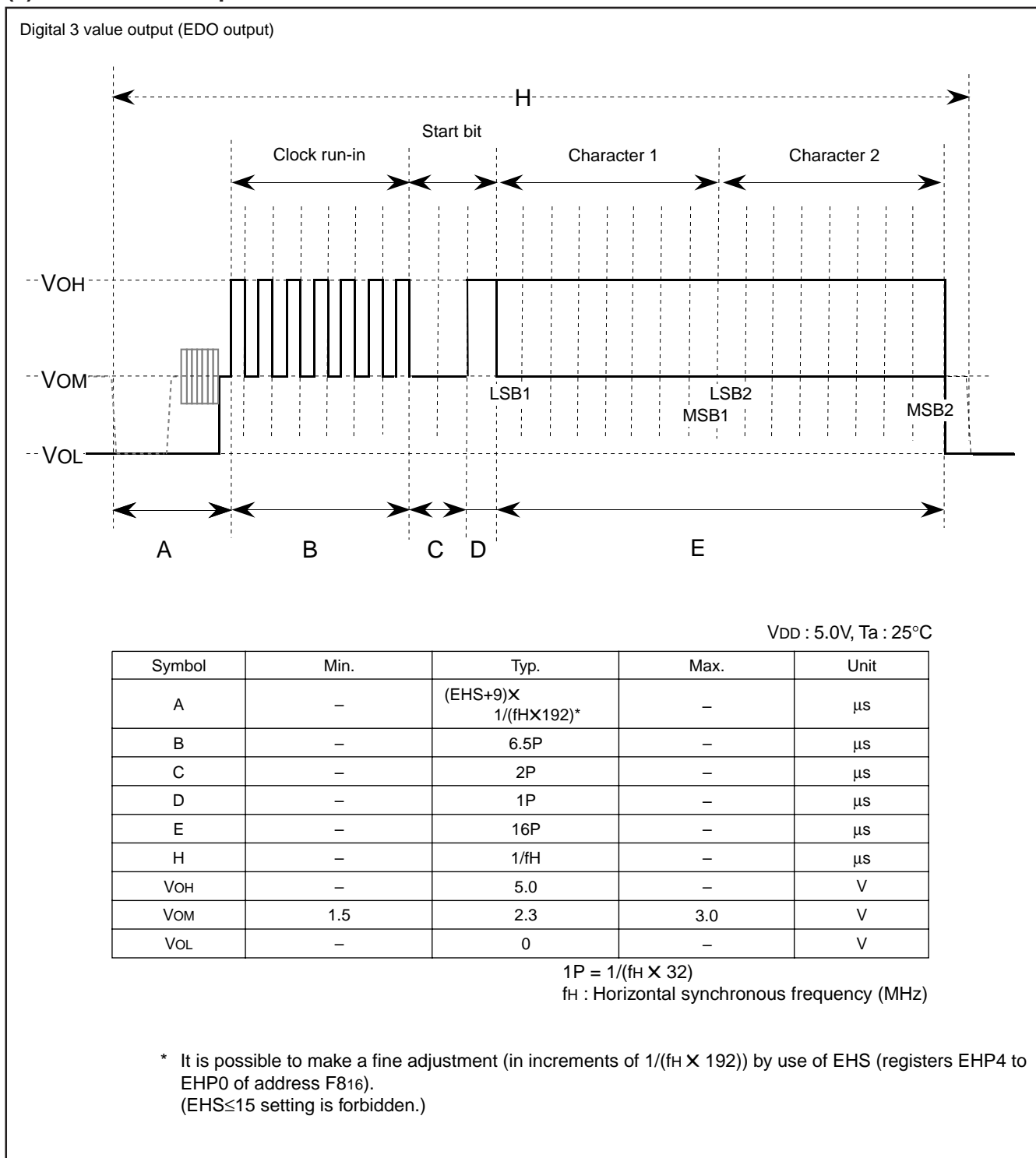

Fig. 14 Encode data output

CHARACTER FONT

Images are composed on a 12 X 18 dot matrix, and characters can be linked vertically and horizontally with other characters to allow the display the continuous symbols.

Character code "FF16" is so fixed as to be blank and to have no background, thus cannot assign a character font to this code.

(1) Border display (set by register BLK0, 1 (address F816))

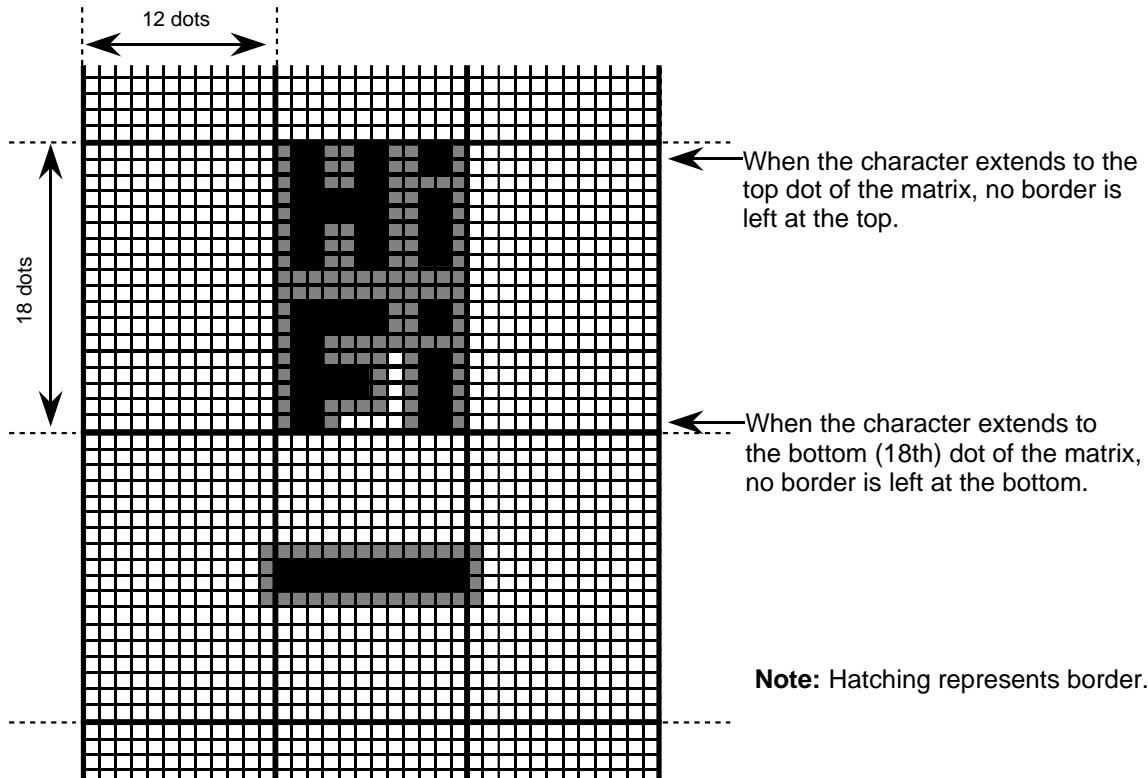

(2) Cursor display (Border display)

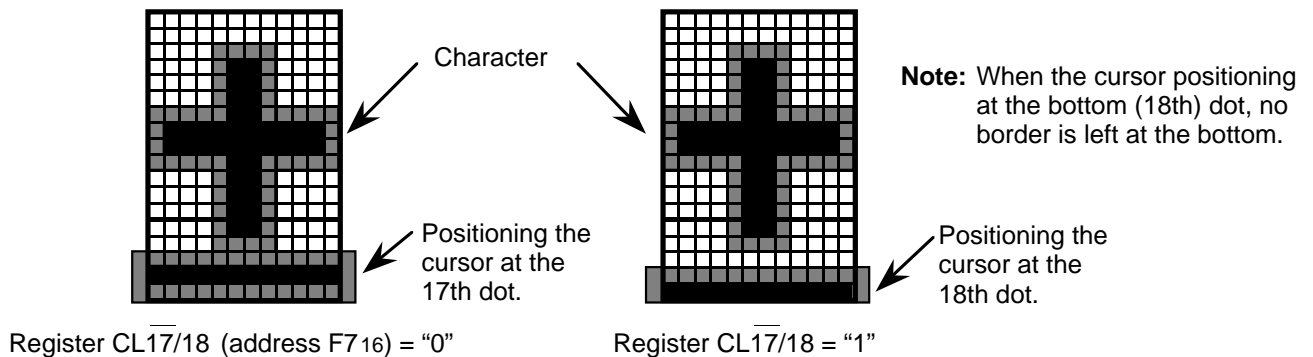

Fig. 15 Character font and border

M35052-XXXSP/FP PERIPHERAL CIRCUIT

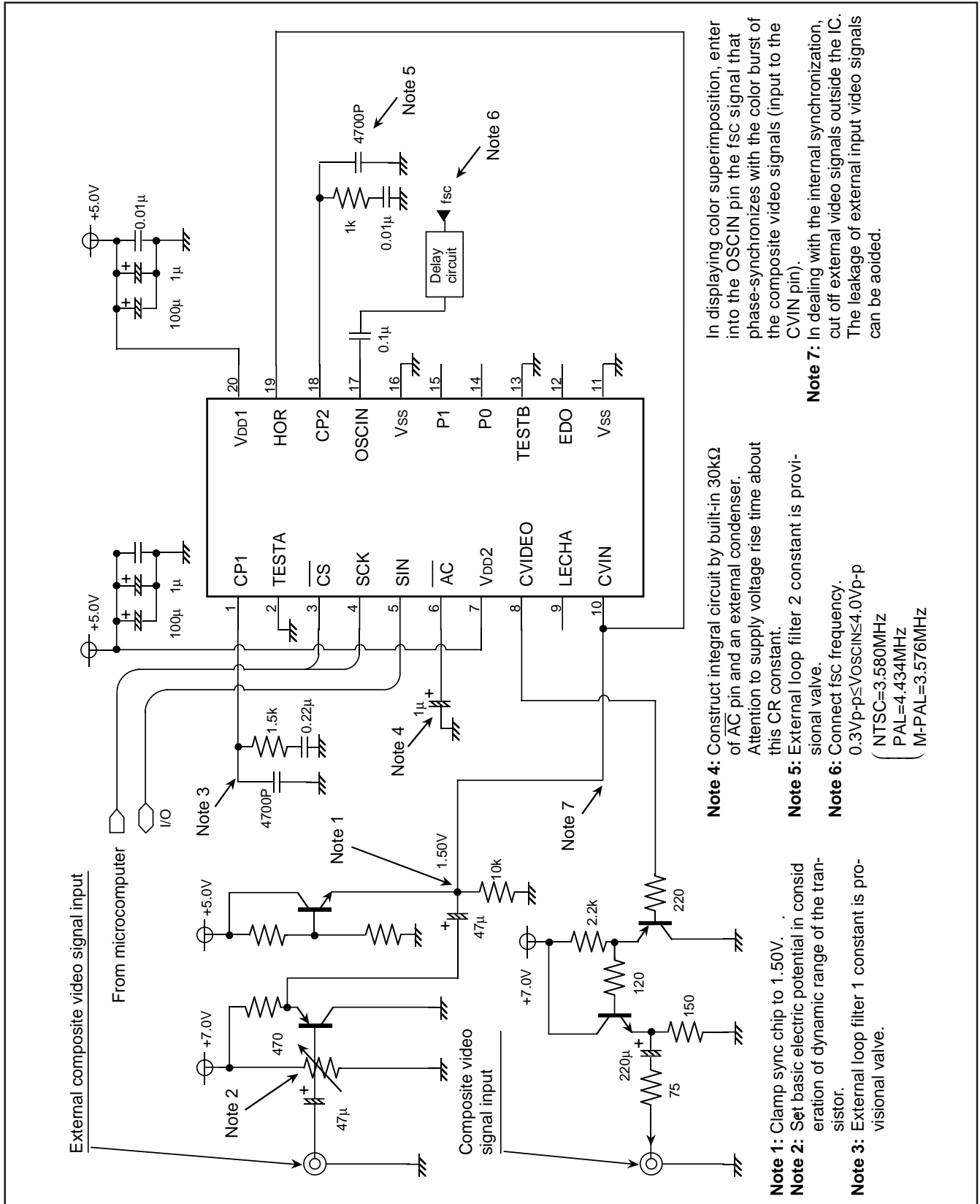

Fig. 16 M35052-XXXSP/FP example of peripheral circuit

- (2) Before setting registers at the starting of system, be sure to reset the M35052-XXXSP/FP by applying "L" level to the $\bar{A}C$ pin.

(3) Power supply noise

When power supply noise is generated, the internal oscillator circuit does not stabilize, whereby causing horizontal jitters across the picture display. Therefore, connect a bypass capacitor between the power supply and GND.

- 3) Wait 20 ms (the period necessary for the internal oscillation circuit to stabilize) before entering data.
4) Set necessary data in other registers, and make the display RAM ready.

(4) Synchronous correction action

When switching channel or in the special playback mode (quick playback, rewinding, and so on) of VTR, effect of synchronous correction becomes strong, and distortion of a character is apt to occur because the continuity of video signal is suddenly switched. When the continuity of video signal is out of order, erasure of displayed characters is recommended in a extreme short time to raise the quality of displayed characters.

(5) Notes on fsc signal input

This IC amplifies the subcarrier frequency (fsc) signal (NTSC, M-PAL system: 3.58MHz, PAL system: 4.43MHz) input to the OSCIN pin (17-pin) and generates the composite video signal internally. The amplified fsc signal can be destabilized in the following cases.

- a) When the fsc signal is outside of recommended operating conditions.
- b) When the waveform of the fsc signal is distorted.
- c) When DC level in the fsc waveform fluctuates.

When the amplified signal is unstable, the composite video signal generated inside the IC is also unstable in terms of synchronization with the subcarrier and phase.

Consequently, this results in color flicker and lost synchronization when the composite video signal is generated. Make note of the fact that this may prevent a stable blue background from being formed.

(6) Forbidding to stop entering the fsc signal

This IC doesn't properly work if the fsc signal is not entered into the OSCIN pin (pin 17), so don't stop the fsc signal so as to work the IC. To stop the IC, turn the display off (set 0 in the register DSPON (address F816).)

(7) Forbidding to set data during the period in which the internal oscillation circuit stabilizes

- a) To start entering the fsc signal when its input is stopped.
- b) To start oscillating the oscillation circuit for display when its oscillation is stopped. (to assign "1" to the register STOP1 (address F816) when it is assigned "0", or the like.)
- c) To turn on the internal bias when it is turned off. (to assign "1" to the register LEVEL1 (address F816) when it is assigned "0".)

There can be instances in which data are not properly set in the registers until the internal oscillation circuit stabilizes, so follow the steps in sequence as given below.

- 1) Set "0" in the register DSPON (address F816). (the display is turned off)
- 2) Effect the settings a), b), and c) given above.

TIMING REQUIREMENTS ($T_a = -20^{\circ}\text{C}$ to 70°C , $V_{DD} = 5 \pm 0.25\text{V}$, unless otherwise noted)

Symbol	Parameter	Limits			Unit
		Min.	Typ.	Max.	
$t_w(\text{SCK})$	SCK width	400	–	–	ns
$t_{su}(\overline{\text{CS}})$	$\overline{\text{CS}}$ setup time	200	–	–	ns
$t_h(\overline{\text{CS}})$	$\overline{\text{CS}}$ hold time	2	–	–	μs
$t_{su}(\text{SIN})$	SIN setup time	200	–	–	ns
$t_h(\text{SIN})$	SIN hold time	200	–	–	ns
t_{word}	1 word writing time	12.8	–	–	μs

Note. When oscillation stop at register STOR1 (address F816), 1V (field term) or more of $t_{su}(\overline{\text{CS}})$ and $t_h(\overline{\text{CS}})$ are needed.

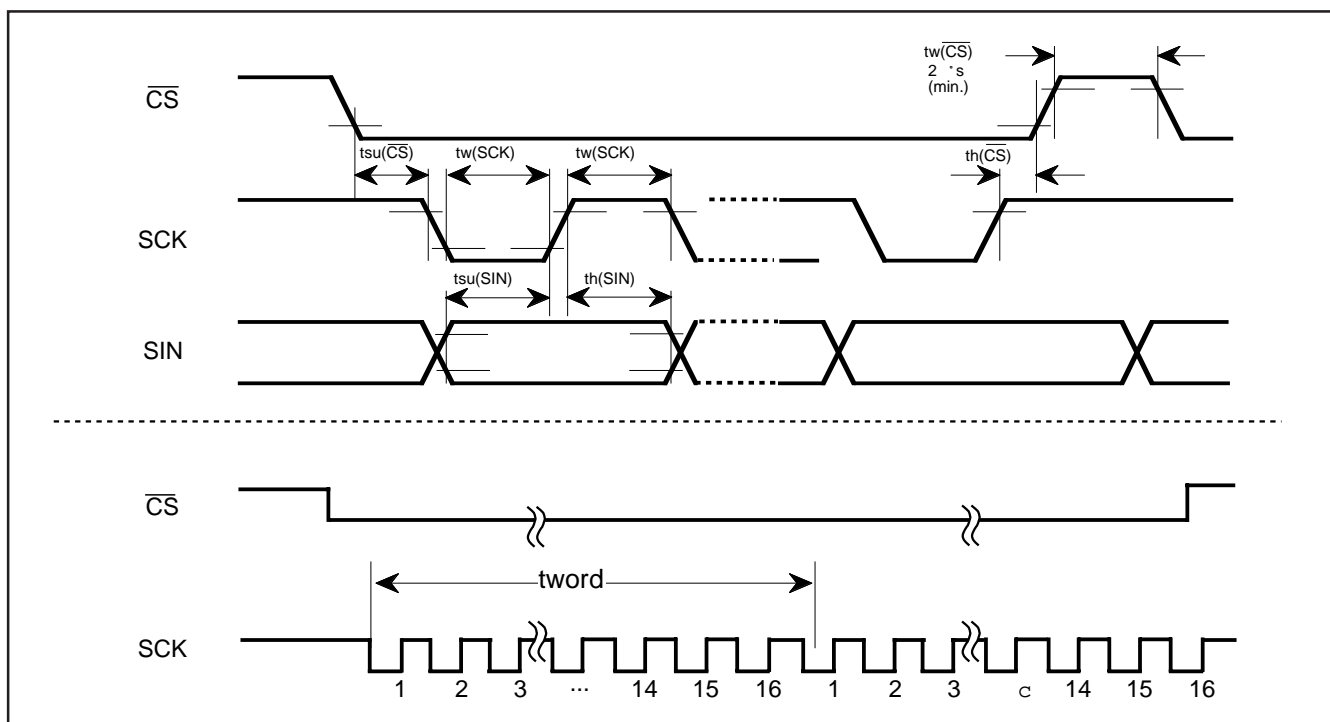

Fig. 19 Serial input timing requirements

SCREEN CHARACTER and PATTERN DISPLAY CONTROLLERS

ABSOLUTE MAXIMUM RATINGS (V_{DD} = 5V, Ta = -20 to 70°C, unless otherwise noted)

Symbol	Parameter	Conditions	Ratings	Unit
V _{DD}	Supply voltage	With respect to V _{SS}	-0.3~6.0	V
V _I	Input voltage		V _{SS} -0.3≤V _I ≤V _{DD} +0.3	V
V _O	Output voltage		V _{SS} ≤V _O ≤V _{DD}	V
P _d	Power dissipation	Ta=25°C	300	mW
T _{opr}	Operating temperature		-20~70	°C
T _{stg}	Storage temperature		-40~125	°C

RECOMMENDED OPERATING CONDITIONS (V_{DD} = 5V, Ta = -20 to 70°C, unless otherwise noted)

Symbol	Parameter	Limits			Unit	
		Min.	Typ.	Max.		
V _{DD}	Supply voltage	4.75	5.00	5.25	V	
V _{IH}	"H" level input voltage \overline{AC} , \overline{CS} , SIN, SCK, TESTA, TESTB	0.8XV _{DD}	V _{DD}	V _{DD}	V	
V _{IL}	"L" level input voltage \overline{AC} , \overline{CS} , SIN, SCK, TESTA, TESTB	0	0	0.2XV _{DD}	V	
V _{CVIN}	CVIN, HOR	-	2.0V _{P-P}	-	V	
V _{OSCIN}	Input voltage OSCIN (Note)	0.3V _{P-P}	-	4.0V _{P-P}	V	
f _{OSCIN}	Synchronous signal oscillation frequency (Duty 40~60%)	-	3.580 4.434 3.576	-	MHz	
f _{OSC1}	Display oscillation frequency	24 charactersX10 lines	-	480xf _H	-	MHz
f _{OSC2}		32 charactersX7 lines	-	640xf _H	-	MHz

Notes 1. Noise component is within 30mV.

2. f_H: Horizontal synchronous frequency (MHz).

ELECTRICAL CHARACTERISTICS (V_{DD} = 5V, Ta = 25°C, unless otherwise noted)

Symbol	Parameter	Test conditions	Limits			Unit
			Min.	Typ.	Max.	
V _{DD}	Supply voltage	Ta=-20~70°C	4.75	5.00	5.25	V
I _{DD}	Supply current	V _{DD} =5.00V	-	30	50	mA
V _{OH}	"H" level output voltage P0, P1, SIN	V _{DD} =4.75V, I _{OH} =-0.4mA	3.75	-	-	V
V _{OL}	"L" level output voltage P0, P1, SIN	V _{DD} =4.75V, I _{OL} =-0.4mA	-	-	0.4	V
R _I	Pull-up resistance \overline{AC} , \overline{CS} , SCK, SIN, TESTB	V _{DD} =5.00V	10	30	100	kΩ
V _{OH}	"H" level output voltage EDO	V _{DD} =5.00V, I _{OH} =-0.04mA	4.0	-	-	V
V _{OM}	"M" level output voltage EDO	V _{DD} =5.00V, I _{OM} =±0.04mA	1.5	2.3	3.0	V
V _{OL}	"L" level output voltage EDO	V _{DD} =5.00V, I _{OL} =0.04mA	-	-	0.4	V

VIDEO SIGNAL INPUT CONDITIONS (V_{DD} = 5V, Ta = -20 to 70°C, unless otherwise noted)

Symbol	Parameter	Test conditions	Limits			Unit
			Min.	Typ.	Max.	
V _{IN-SC}	Composite video signal input clamp voltage	Sync-chip voltage	-	1.5	-	V

Note for Supplying Power

(1) Timing of power supplying to AC pin

The internal circuit of M35052-XXXSP/FP is reset when the level of the auto clear input pin AC is "L". This pin is hysteresis input with the pull-up resistor. The timing about power supplying of AC pin is shown in Figure 20. t_w is the interval after the supply voltage becomes $0.8 \times V_{DD}$ or more and before the supply voltage to the AC pin (V_{AC}) becomes $0.2 \times V_{DD}$ or more.

After supplying the power (V_{DD} and V_{SS}) to M35052-XXXSP/FP, the t_w time must be reserved for 1ms or more. Before starting

input from the microcomputer, the waiting time (t_s) must be reserved for 500ms after the supply voltage to the AC pin becomes $0.8 \times V_{DD}$ or more.

(2) Timing of power supplying to VDD1 pin and VDD2 pin

The power need to supply to VDD1 and VDD2 at a time, though it is separated perfectly between the VDD1 as the digital line and the VDD2 as the analog line.

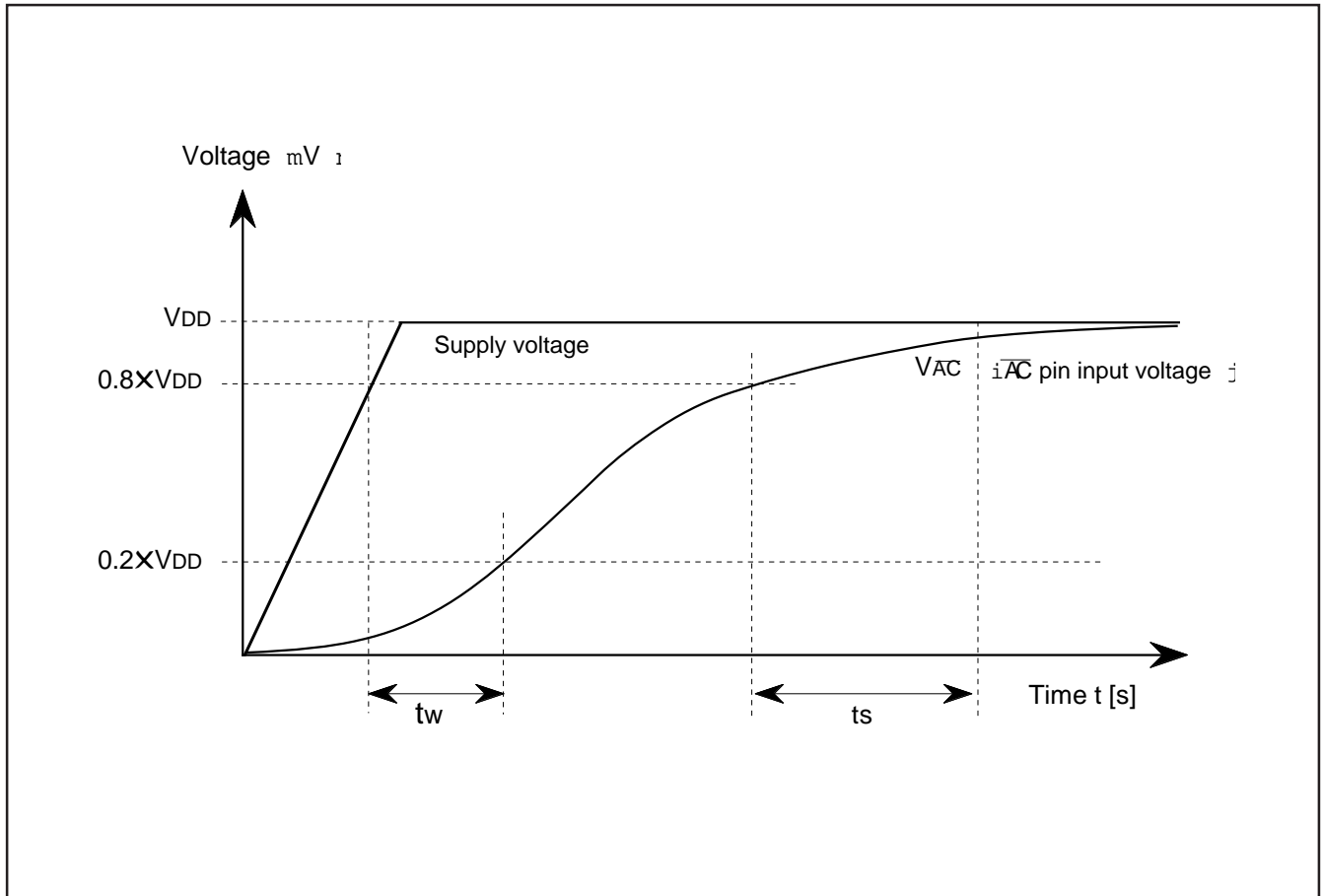

Fig. 20 Timing of power supplying to AC pin

PRECAUTION FOR USE

Notes on noise and latch-up

Connect a capacitor (approx. $0.1 \mu F$) between pins VDD and VSS at the shortest distance using relatively thick wire to prevent noise and latch up.

ROM ORDERING METHOD

Please submit the information described below when ordering Mask ROM.

- (1) ROM Order Confirmation Form 1
- (2) Data to be written into mask ROM EPROM
(three sets containing the identical data)
- (3) Mark Specification Form 1
- (4) Program for character font generating + floppy disk in which character data is input

STANDARD ROM TYPE : M35052-001SP/FP

M35052-001SP/FP is a standard ROM type of M35052-XXXSP/FP
 Character patterns are fixed to the contents of Figure 21 to 23.

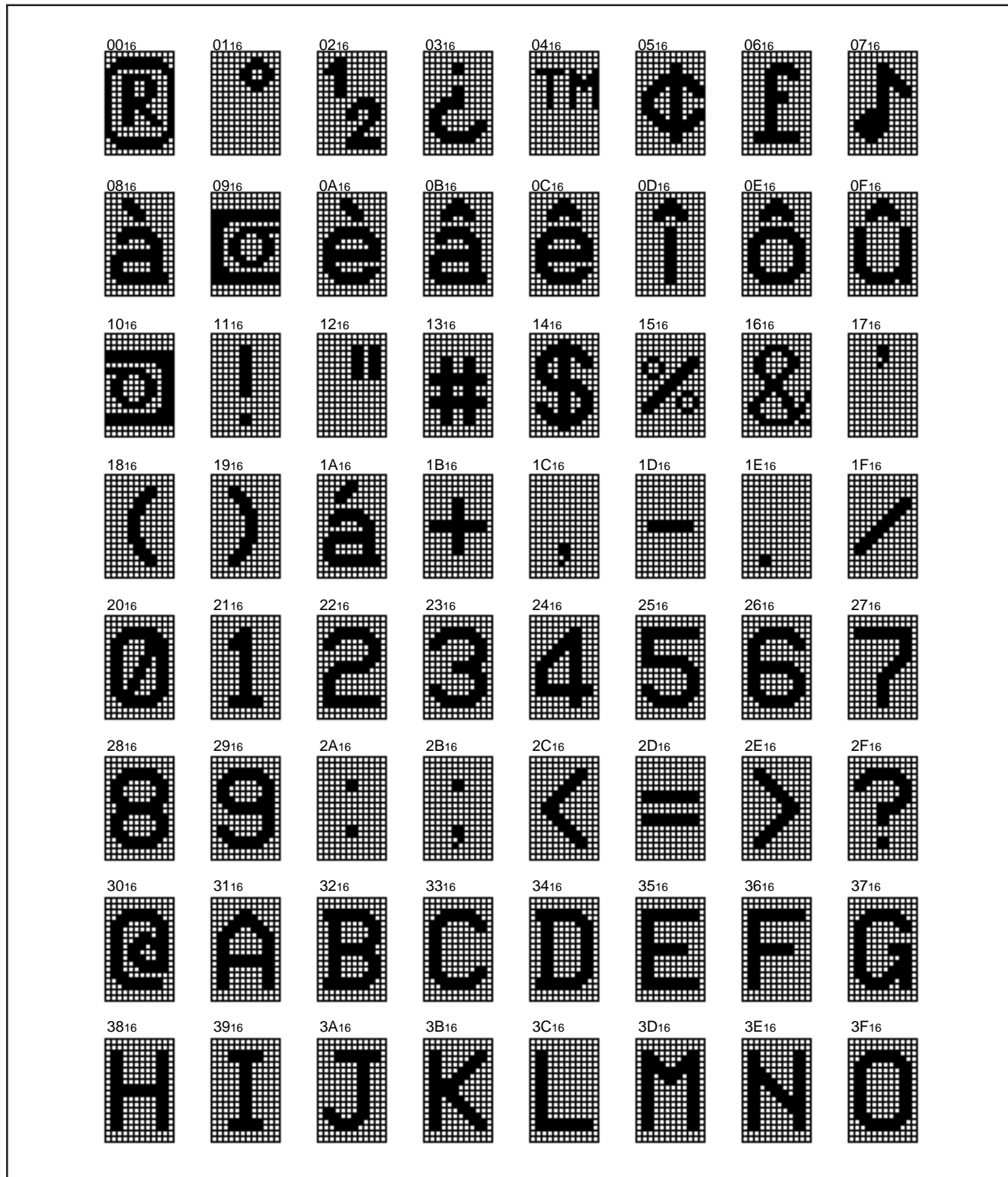

Fig. 21 M35052-001SP/FP character patterns (1)

SCREEN CHARACTER and PATTERN DISPLAY CONTROLLERS

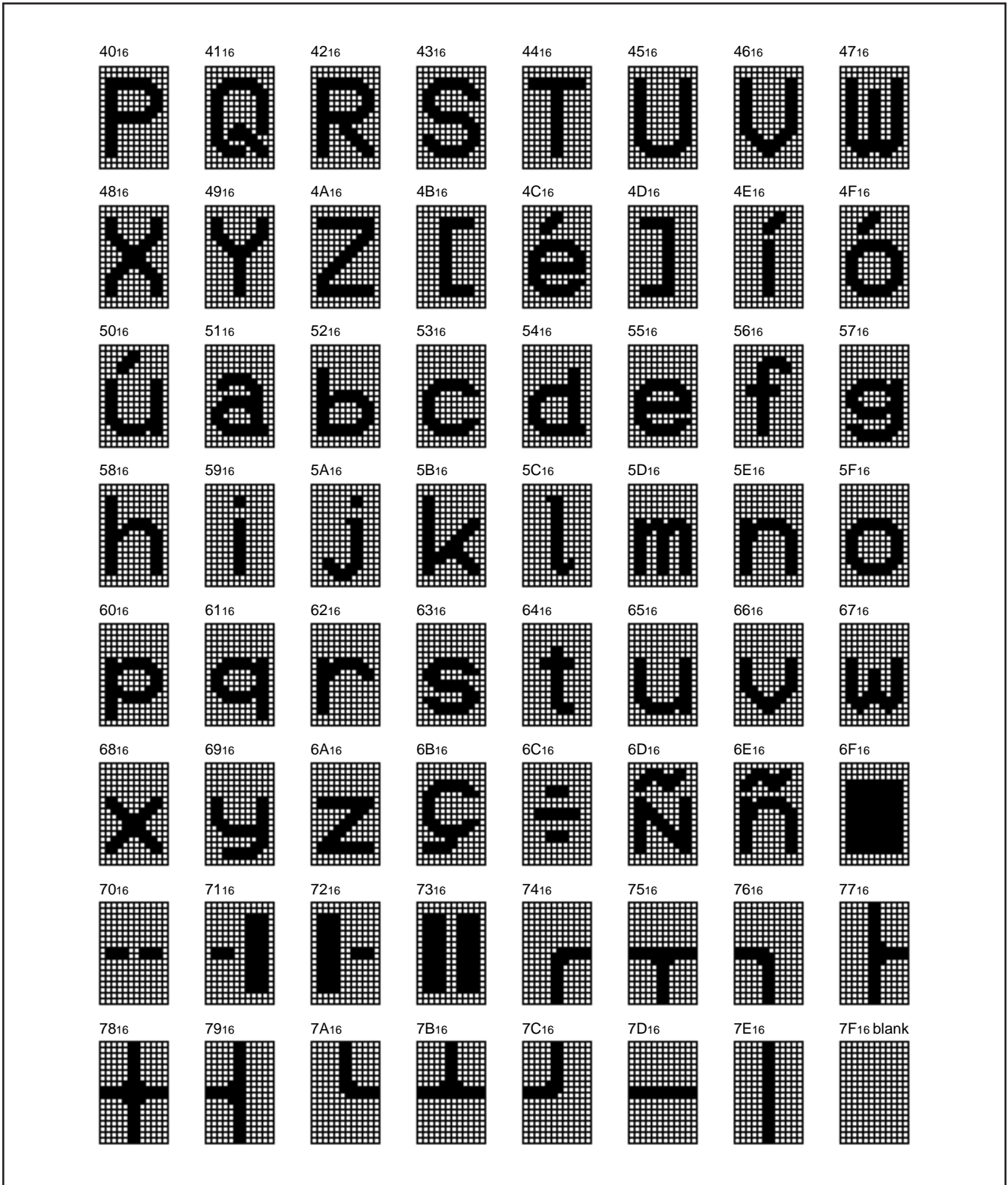

Fig. 22 M35052-001SP/FP character patterns (2)

MASK ROM ORDER CONFIRMATION FORM

GZZ-SH00-50B<69A0>

Mask ROM number	
-----------------	--

**MASK ROM ORDER CONFIRMATION FORM
SCREEN DISPLAY IC M35052-XXXSP/FP
MITSUBISHI ELECTRIC**

Receipt	Data :	
	Section head signature	Supervisor signature

Note : Please fill in all items marked *, .

* Customer	Company name	TEL ()	Issuance signature	Approval	Verification	Framing
	Data issued	Date :				

* Program version name	M052R	V
------------------------	-------	---

* Remarks

- Return the Character Font Preparation Program after use.
- Three EPROMs are required. Specify the type of EPROMs submitted. (All the three EPROMs must be same types. Check in the appropriate box.)

27256 27512

(1) The font data prepared by the Character Font Preparation Program is saved as a binary type object file (addresses 0000h to 7FFFh). Three sets of these EPROMs are required.

(2) Attach the erase protect seals on three EPROMs. Each seal bears the type name (M35052), and ROM No. (-...SP/FP).

- Write the checksum code (hexadecimal notation) for entire EPROM areas.

Checksum

--	--	--	--

- Select the marking type (Check in the appropriate box).

Special Mark Fill in the Mark Specification Form (20P4B for M35052-XXXSP, 20P2Q-A for M35052-XXXFP) and attach to the Mask ROM Order Confirmation Form.

Standard Mark No writing is required.

- The package type

..... SDIP type (M35052-XXXSP)

..... SSOP type (M35052-XXXFP)

* ● Comments

GZZ-SH00-50B<69A0>

Mask ROM number	
-----------------	--

※2.Character patterns (The patterns with the mark “#” are test patterns)

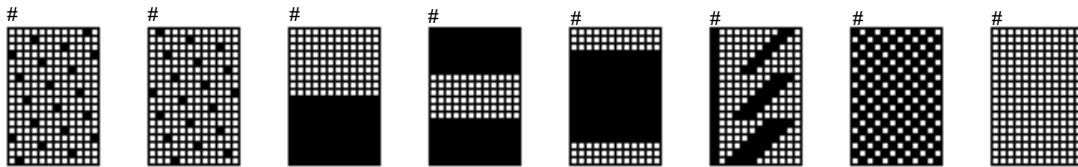

(See the next page)

SCREEN CHARACTER and PATTERN DISPLAY CONTROLLERS

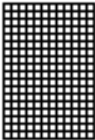
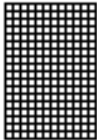
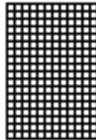
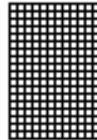
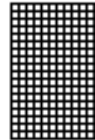
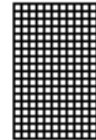
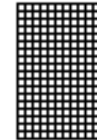
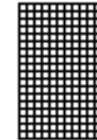
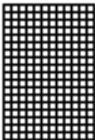
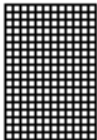
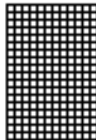
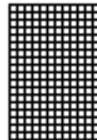
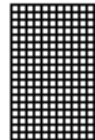
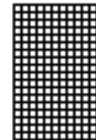
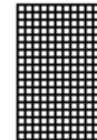
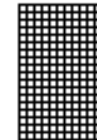
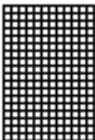
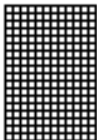
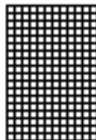
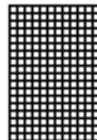
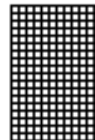
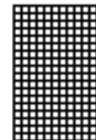
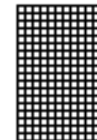
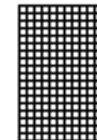
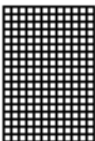
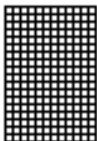
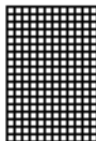
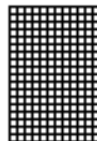
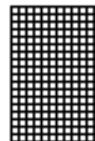
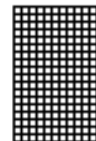
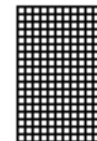
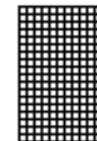
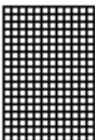
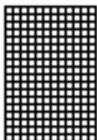
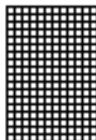
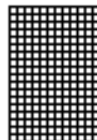
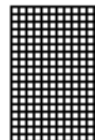
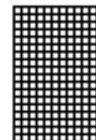
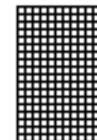
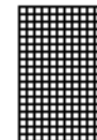
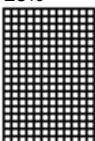
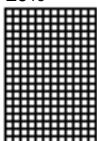
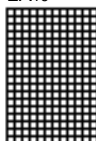
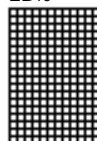
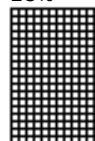
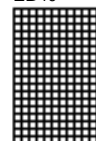
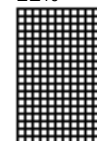
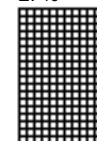
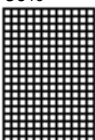
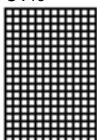
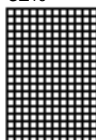
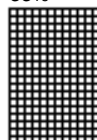
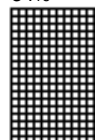
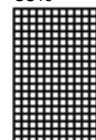
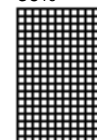
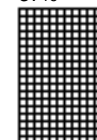
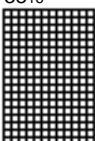
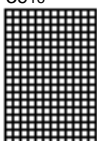
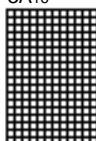
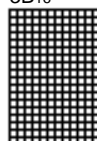
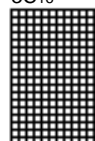
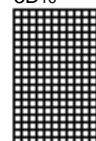
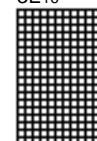
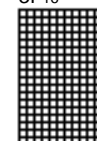
00 ₁₆ 	01 ₁₆ 	02 ₁₆ 	03 ₁₆ 	04 ₁₆ 	05 ₁₆ 	06 ₁₆ 	07 ₁₆ 
08 ₁₆ 	09 ₁₆ 	0A ₁₆ 	0B ₁₆ 	0C ₁₆ 	0D ₁₆ 	0E ₁₆ 	0F ₁₆ 
10 ₁₆ 	11 ₁₆ 	12 ₁₆ 	13 ₁₆ 	14 ₁₆ 	15 ₁₆ 	16 ₁₆ 	17 ₁₆ 
18 ₁₆ 	19 ₁₆ 	1A ₁₆ 	1B ₁₆ 	1C ₁₆ 	1D ₁₆ 	1E ₁₆ 	1F ₁₆ 
20 ₁₆ 	21 ₁₆ 	22 ₁₆ 	23 ₁₆ 	24 ₁₆ 	25 ₁₆ 	26 ₁₆ 	27 ₁₆ 
28 ₁₆ 	29 ₁₆ 	2A ₁₆ 	2B ₁₆ 	2C ₁₆ 	2D ₁₆ 	2E ₁₆ 	2F ₁₆ 
30 ₁₆ 	31 ₁₆ 	32 ₁₆ 	33 ₁₆ 	34 ₁₆ 	35 ₁₆ 	36 ₁₆ 	37 ₁₆ 
38 ₁₆ 	39 ₁₆ 	3A ₁₆ 	3B ₁₆ 	3C ₁₆ 	3D ₁₆ 	3E ₁₆ 	3F ₁₆ 

(3/6)

SCREEN CHARACTER and PATTERN DISPLAY CONTROLLERS

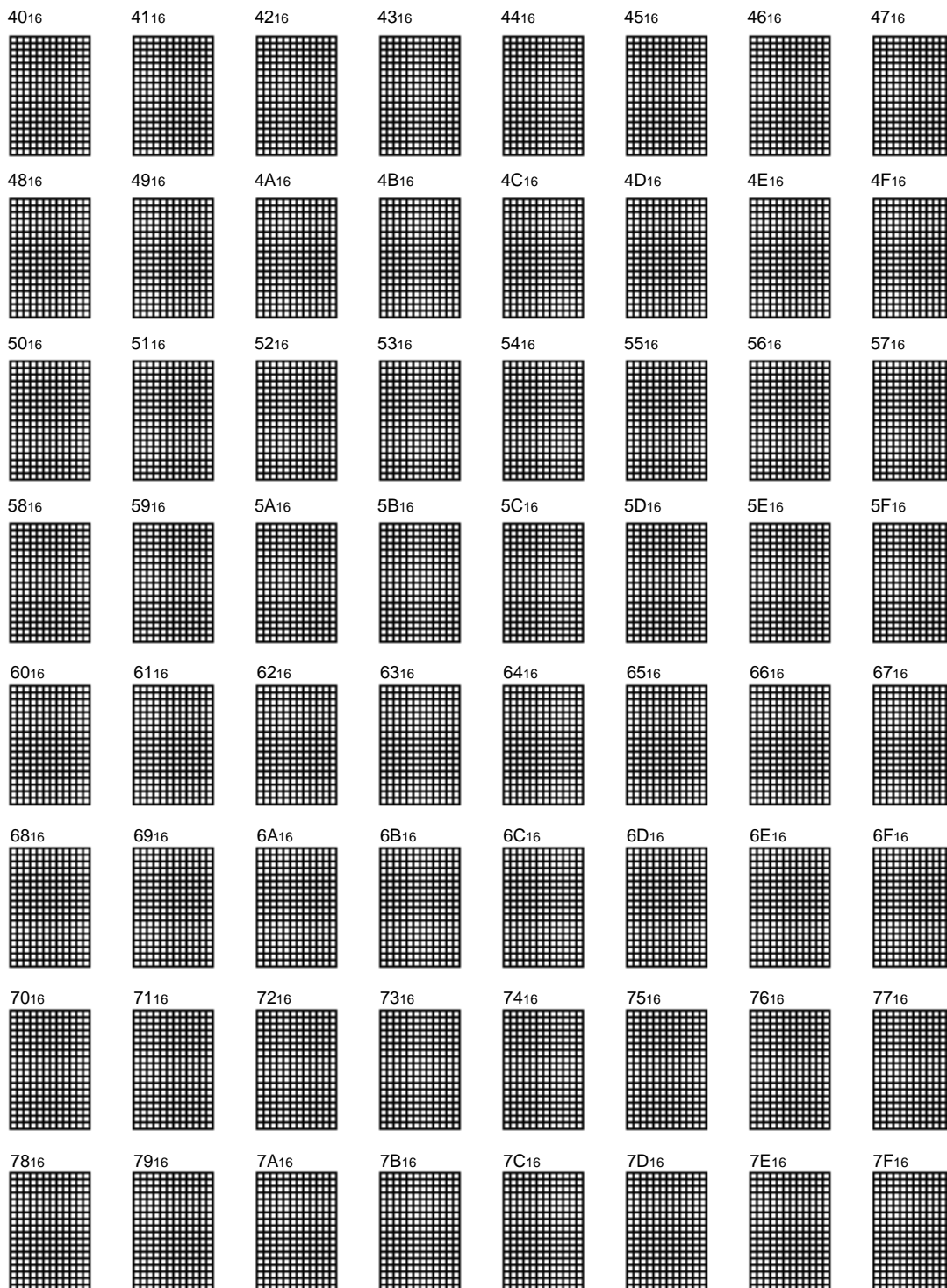

SCREEN CHARACTER and PATTERN DISPLAY CONTROLLERS

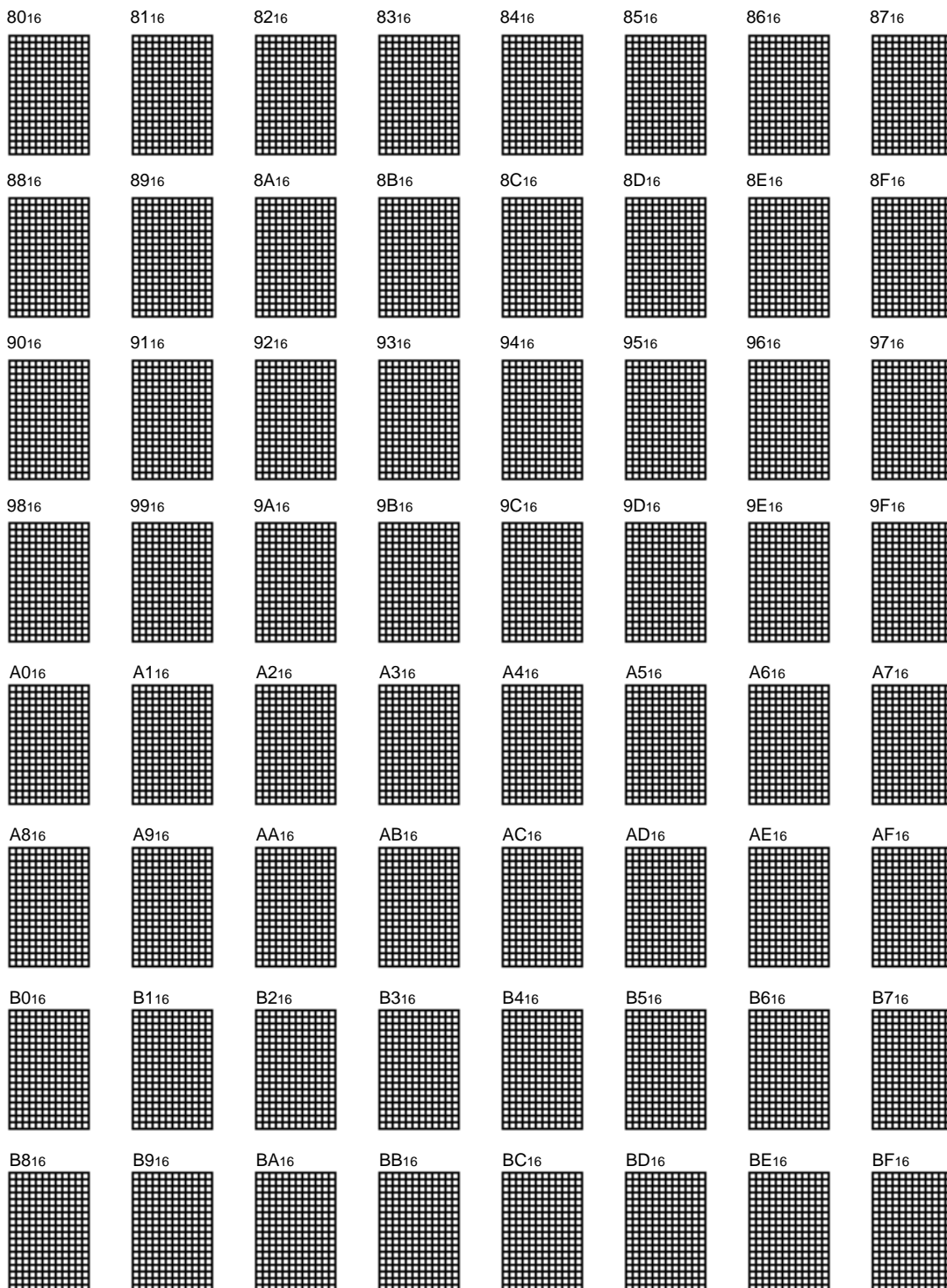

SCREEN CHARACTER and PATTERN DISPLAY CONTROLLERS

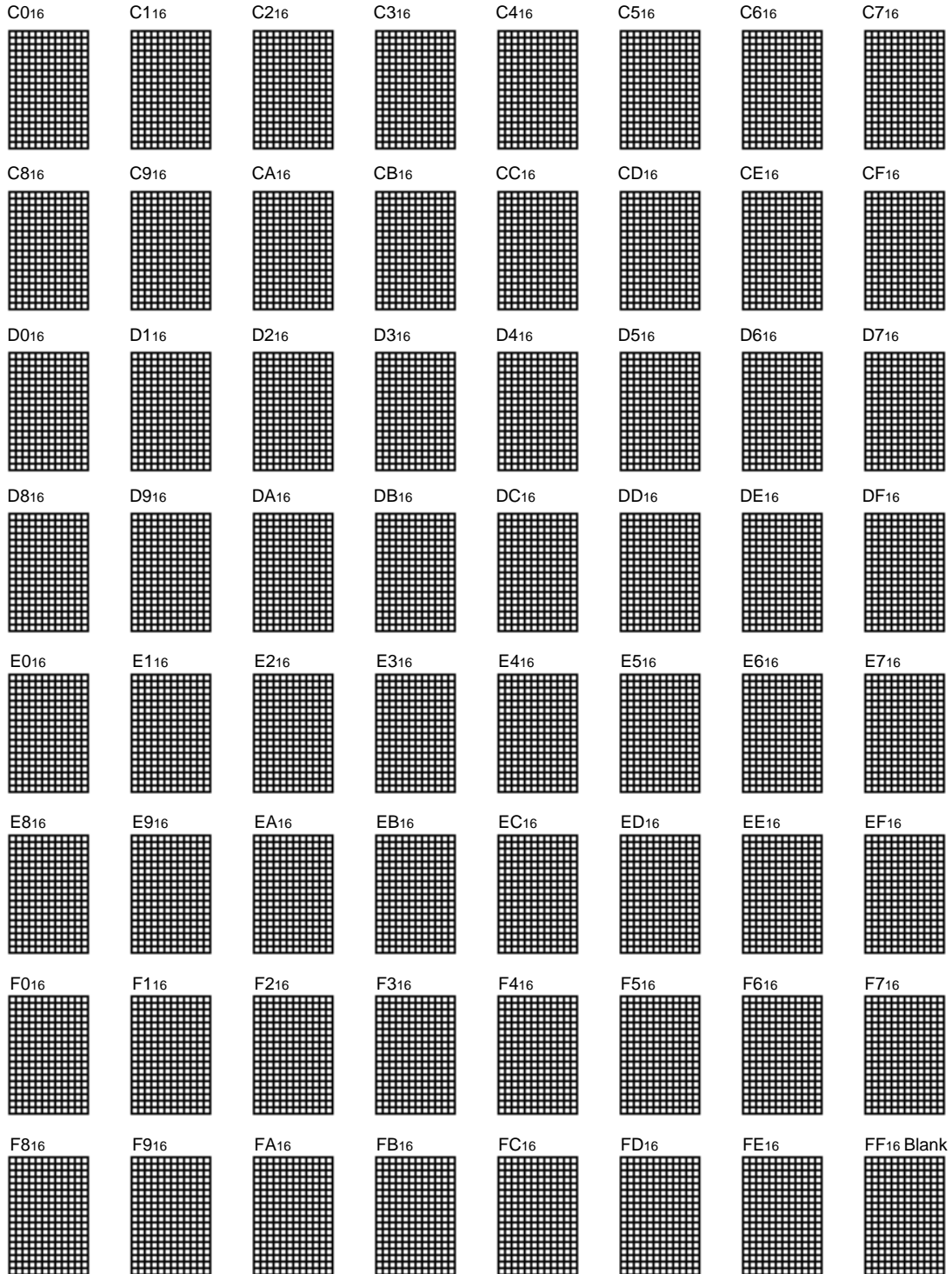

20P4B (20-PIN DIP) MARK SPECIFICATION FORM

Mitsubishi IC catalog name

Please choose one of the marking types below (A, B, C), and enter the Mitsubishi catalog name and the special mark (if needed).

A. Standard Mitsubishi Mark

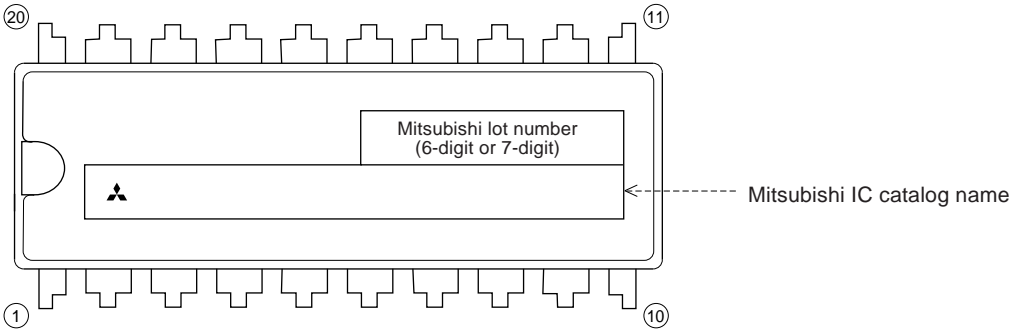

B. Customer's Parts Number + Mitsubishi catalog name

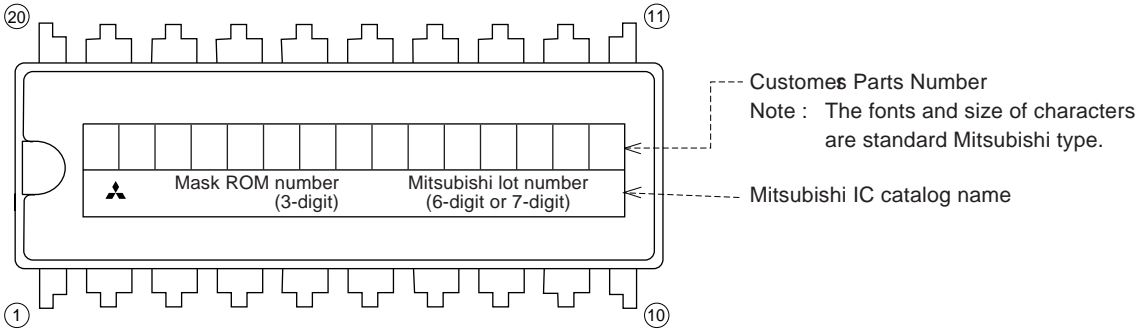

- Note1 : The mark field should be written right aligned.
- 2 : The fonts and size of characters are standard Mitsubishi type.
- 3 : Customer's Parts Number can be up to 15 characters : Only 0 ~ 9, A ~ Z, +, -, /, (,), &, @, . (periods), and , (commas) are usable.
- 4 : If the Mitsubishi logo is not required, check the box on the right.

▲ Mitsubishi logo is not required

C. Special Mark Required

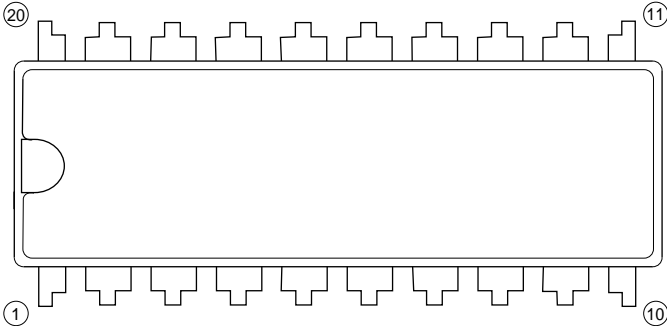

- Note1 : If the Special Mark is to be Printed, indicate the desired layout of the mark in the upper figure. The layout will be duplicated as close as possible. Mitsubishi lot number (6-digit or 7-digit) and Mask ROM number (3-digit) are always marked.
- 2 : If the customer's trade mark logo must be used in the Special Mark, check the box on the right. Please submit a clean original of the logo. For the new special character fonts a clean font original (ideally logo drawing) must be submitted.

Special logo required

20P2Q-A (20-PIN SSOP) MARK SPECIFICATION FORM

Mitsubishi IC catalog name

Please choose one of the marking types below (A, B, C), and enter the Mitsubishi IC catalog name and the special mark (if needed).

A. Standard Mitsubishi Mark

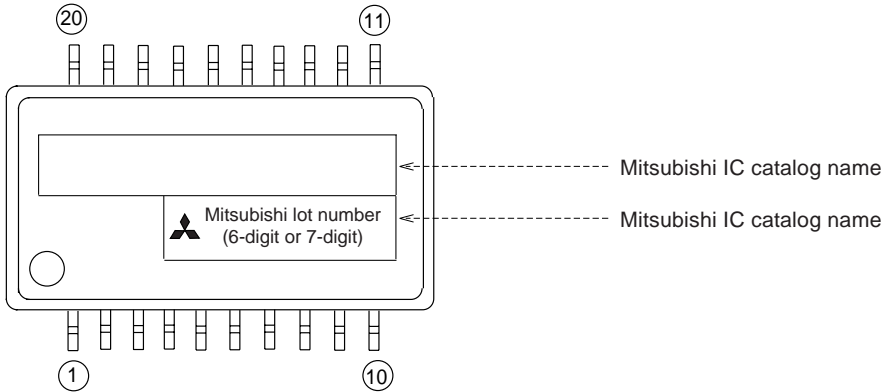

B. Customer's Parts Number + Mitsubishi IC Catalog Name

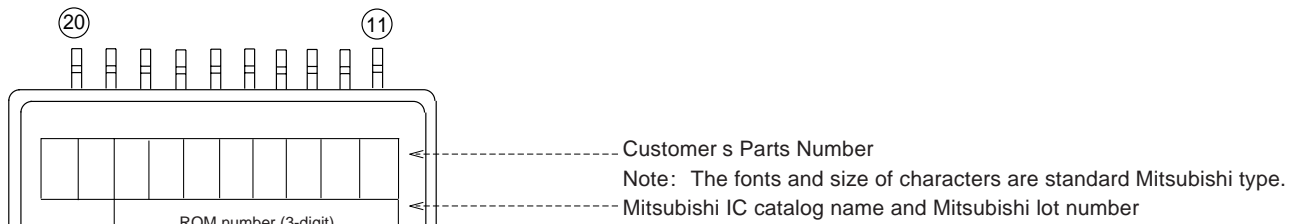

- Notes 1 : The mark field should be written right aligned.
 2 : The fonts and size of characters are standard Mitsubishi type.
 3 : Customer's Parts Number can be up to 10 characters: Only 0 to 9, A to Z, +, -, /, (,), &, ', . (period), and , (comma) are usable.
 4 : If the Mitsubishi logo is not required, check the box below.

Mitsubishi logo is not required

C. Special Mark Required

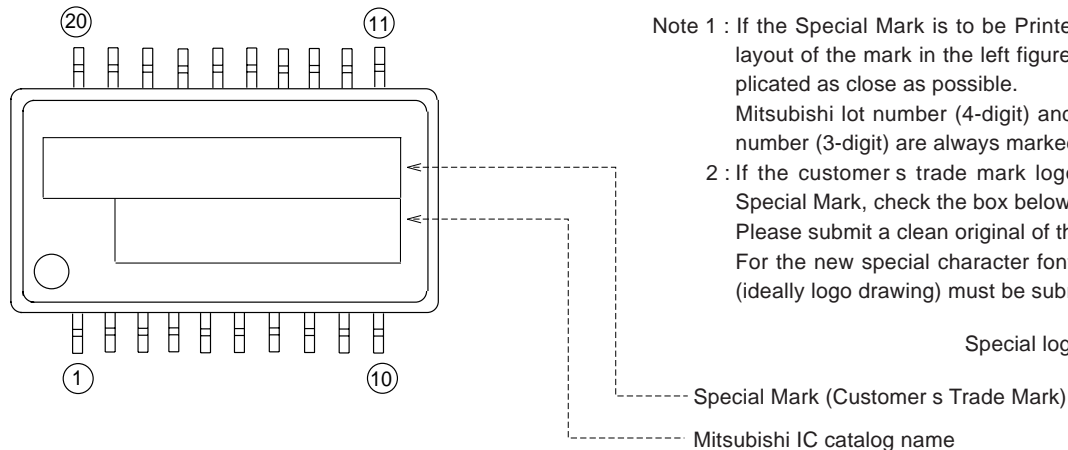

Note 1 : If the Special Mark is to be Printed, indicate the desired layout of the mark in the left figure. The layout will be duplicated as close as possible.

Mitsubishi lot number (4-digit) and Mask ROM number (3-digit) are always marked.

2 : If the customer's trade mark logo must be used in the Special Mark, check the box below.

Please submit a clean original of the logo.

For the new special character fonts, a clean font original (ideally logo drawing) must be submitted.

Special logo required

PACKAGE OUTLINE

20P4B

Plastic 20pin 300mil SDIP

EIAJ Package Code SDIP20-P-300-1.78	JEDEC Code —	Weight (g) 1.0	Lead Material
--	-----------------	-------------------	---------------

Scale : 2.5/1

Symbol	Dimension in Millimeters		
	Min	Nom	Max
A	—	—	4.5
A ₁	0.51	—	—
A ₂	—	3.3	—
b	0.38	0.48	0.58
b ₁	0.9	1.0	1.3
c	0.22	0.27	0.34
D	18.8	19.0	19.2
E	6.15	6.3	6.45
e	—	1.778	—
e ₁	—	7.62	—
L	3.0	—	—
θ	0°	—	15°

20P2Q-A

Plastic 20pin 300mil SSOP

EIAJ Package Code SSOP20-P-0300	JEDEC Code —	Weight (g) 0.2	Lead Material Cu Alloy
------------------------------------	-----------------	-------------------	---------------------------

Scale : 4/1

Recommended Mount Pad

Symbol	Dimension in Millimeters		
	Min	Nom	Max
A	—	—	2.1
A ₁	0	0.1	0.2
A ₂	—	1.8	—
b	0.3	0.35	0.45
c	0.18	0.2	0.25
D	10.0	10.1	10.2
E	5.2	5.3	5.4
e	—	0.8	—
HE	7.5	7.8	8.1
L	0.4	0.6	0.8
L ₁	—	1.25	—
y	—	—	0.1
θ	0°	—	8°
b ₂	—	0.5	—
e ₁	—	7.62	—
l ₂	1.27	—	—



Keep safety first in your circuit designs!

- Mitsubishi Electric Corporation puts the maximum effort into making semiconductor products better and more reliable, but there is always the possibility that trouble may occur with them. Trouble with semiconductors may lead to personal injury, fire or property damage. Remember to give due consideration to safety when making your circuit designs, with appropriate measures such as (i) placement of substitutive, auxiliary circuits, (ii) use of non-flammable material or (iii) prevention against any malfunction or mishap.

Notes regarding these materials

- These materials are intended as a reference to assist our customers in the selection of the Mitsubishi semiconductor product best suited to the customer's application; they do not convey any license under any intellectual property rights, or any other rights, belonging to Mitsubishi Electric Corporation or a third party.
- Mitsubishi Electric Corporation assumes no responsibility for any damage, or infringement of any third-party's rights, originating in the use of any product data, diagrams, charts, programs, algorithms, or circuit application examples contained in these materials.
- All information contained in these materials, including product data, diagrams, charts, programs and algorithms represents information on products at the time of publication of these materials, and are subject to change by Mitsubishi Electric Corporation without notice due to product improvements or other reasons. It is therefore recommended that customers contact Mitsubishi Electric Corporation or an authorized Mitsubishi Semiconductor product distributor for the latest product information before purchasing a product listed herein.
- The information described here may contain technical inaccuracies or typographical errors. Mitsubishi Electric Corporation assumes no responsibility for any damage, liability, or other loss rising from these inaccuracies or errors. Please also pay attention to information published by Mitsubishi Electric Corporation by various means, including the Mitsubishi Semiconductor home page (<http://www.mitsubishichips.com>).
- When using any or all of the information contained in these materials, including product data, diagrams, charts, programs, and algorithms, please be sure to evaluate all information as a total system before making a final decision on the applicability of the information and products. Mitsubishi Electric Corporation assumes no responsibility for any damage, liability or other loss resulting from the information contained herein.
- Mitsubishi Electric Corporation semiconductors are not designed or manufactured for use in a device or system that is used under circumstances in which human life is potentially at stake. Please contact Mitsubishi Electric Corporation or an authorized Mitsubishi Semiconductor product distributor when considering the use of a product contained herein for any specific purposes, such as apparatus or systems for transportation, vehicular, medical, aerospace, nuclear, or undersea repeater use.
- The prior written approval of Mitsubishi Electric Corporation is necessary to reprint or reproduce in whole or in part these materials.
- If these products or technologies are subject to the Japanese export control restrictions, they must be exported under a license from the Japanese government and cannot be imported into a country other than the approved destination. Any diversion or reexport contrary to the export control laws and regulations of Japan and/or the country of destination is prohibited.
- Please contact Mitsubishi Electric Corporation or an authorized Mitsubishi Semiconductor product distributor for further details on these materials or the products contained therein.



REVISION DESCRIPTION LIST

M35052-XXXSP/FP DATA SHEET

Rev. No.	Revision Description	Rev. date
1.0	First Edition	980402
1.1	P41 20P2Q-A (20-PIN SSOP) MARK SPECIFICATION FORM B: Note 4 added	000707