

MITSUBISHI MICROCOMPUTERS

M35054-XXXFP/M35055-XXXFP

SCREEN CHARACTER and PATTERN DISPLAY CONTROLLERS

DESCRIPTION

The M35054-XXXFP and M35055-XXXFP are TV screen display control IC which can be used to display information such as number of channels, the date and messages and program schedules on the TV screen.

In particular, owing to the built-in SYNC-SEP (synchronous separation) circuit, the synchronous correction circuit, external circuits can be decrease and character turbulence that occurs when superimposing can be reduced. The processor is suitable for AV systems such as VTRs, LDs, and so on.

It is a silicon gate CMOS process and M35054-XXXFP and M35055-XXXFP are housed in a 20-pin shrink SOP package.

For M35054-001FP/M35055-001FP that are a standard ROM versions of M35054-XXXFP/M35055-XXXFP respectively, the character pattern is also mentioned.

FEATURES

- Screen composition 24 characters X 10 lines,
32 characters X 7 lines
- Number of characters displayed 240 (Max.)
- Character composition 12 X 18 dot matrix
- Characters available 128 characters (M35054)
256 characters (M35055)
- Character sizes available 4 (horizontal) X 4 (vertical)
- Display locations available
Horizontal direction 240 locations
Vertical direction 256 locations
- Blinking Character units
Cycle : approximately 1 second, or approximately 0.5 seconds
Duty : 25%, 50%, or 75%
- Data input By the serial input function (16 bits)
- Coloring
Background coloring (composite video signal)
- Blanking
Total blanking (14 X 18 dots)
Border size blanking
Character size blanking
- Synchronizing signal
Composite synchronizing signal generation
(PAL, NTSC, M-PAL)
- 2 output ports (1 digital line)
- Oscillation stop function
It is possible to stop the oscillation for synchronizing signal generation
- Built-in half-tone display function
- Built-in reversed character display function
- Built-in synchronous correction circuit
- Built-in synchronous separation circuit

APPLICATION

TV, VCR, Movie

PIN CONFIGURATION (TOP VIEW)

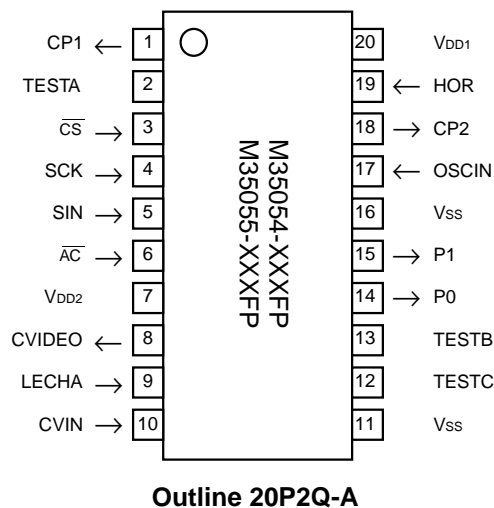

PIN DESCRIPTION

Symbol	Pin name	Input/ Output	Function
OSC1	Clock input	Input	This is the filter output pin 1.
TESTA	Test pin input	—	This is the pin for test. Connect this pin to GND during normal operation.
$\overline{\text{CS}}$	Chip select input	Input	This is the chip select pin, and when serial data transmission is being carried out, it goes to "L". Hysteresis input. Built-in pull-up resistor.
SCK	Serial clock input	Input	When $\overline{\text{CS}}$ pin is "L", SIN serial data is taken in when SCK rises. Hysteresis input. Built-in pull-up resistor.
SIN	Serial data input	Input	This is the pin for serial input of data and addresses for the display control register and the display data memory. Hysteresis input. Built-in pull-up resistor.
$\overline{\text{AC}}$	Auto-clear input	Input	When "L", this pin resets the internal IC circuit. Hysteresis input. Built-in pull-up resistor.
VDD2	Power pin	—	Please connect to +5V with the analog circuit power pin.
CVIDEO	Composite video signal output	Output	This is the output pin for composite video signals. It outputs 2V _{P-P} composite video signals. In superimpose mode, character output etc. is superimposed on the external composite video signals from CVIN.
LECHA	Character level input	Input	This is the input pin which determines the "white" character color level in the composite video signal.
CVIN	Composite video signal input	Input	This is the input pin for external composite video signals. In superimpose mode, character output etc. is superimposed on these external composite video signals.
Vss	Earthing pin	—	Please connect to GND using circuit earthing pin.
TESTC	Test pin output	—	This is the pin for test. Open this pin during normal operation.
TESTB	Test pin input	—	This is the pin for test. Connect this pin to GND during normal operation.
P0	Port P0 output	Output	This pin outputs the port output or BLNK1 (character background) signal.
P1	Port P1 output	Output	This pin outputs the port output or CO1(character) signal.
Vss	Earthing pin	—	Please connect to GND using circuit earthing pin (Analog side).
OSCIN	fsc input pin for synchronous signal generation	Input	This is the input pin for the sub-carrier frequency (fsc) for generating a synchronous signal. A frequency of 3.580MHz is needed for NTSC, and a frequency of 4.434MHz is needed for PAL and 3.576MHz is needed for M-PAL.
CP2	Filter output	Output	Filter output pin 2.
HOR	Horizontal synchronizing signal input	Input	This is the input pin for external composite video signals. This pin inputs the external video signal clamped sync-chip to 1.5V, and internally carries out synchronous separation.
VDD1	Power pin	—	Please connect to +5V with the digital circuit power pin.

M35054-XXXFP/M35055-XXXFP

SCREEN CHARACTER and PATTERN DISPLAY CONTROLLERS

BLOCK DIAGRAM

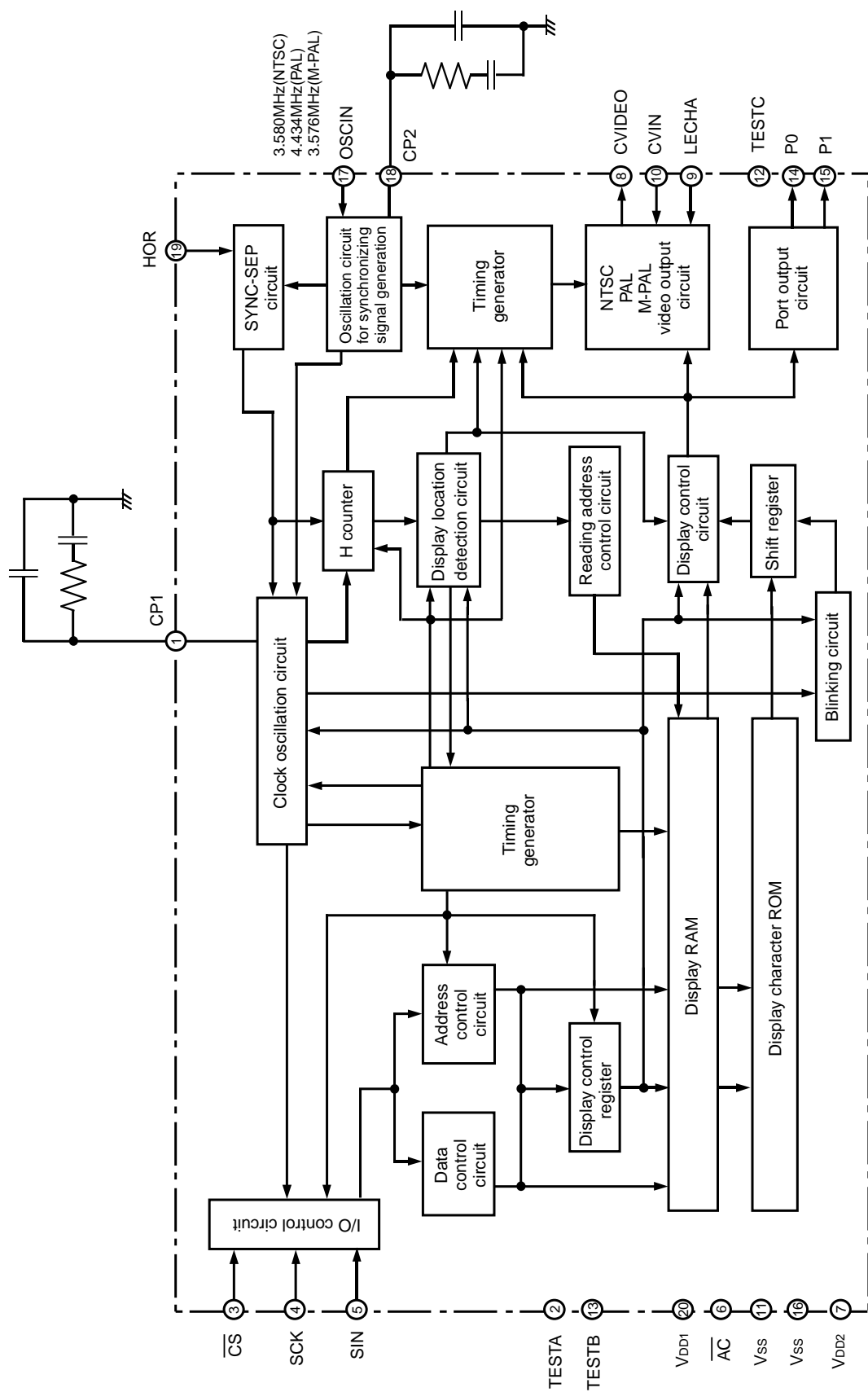

M35054-XXXFP/M35055-XXXFP

SCREEN CHARACTER and PATTERN DISPLAY CONTROLLERS

MEMORY CONSTITUTION

Address 00₁₆ to EF₁₆ are assigned to the display RAM, address F0₁₆ to F8₁₆ are assigned to the display control registers.

The internal circuit is reset and all display control registers (address F0₁₆ to F8₁₆) are set to "0" and display RAM (address 00₁₆ to EF₁₆) are RAM erased when the AC pin level is "L".

When using M35054-XXXFP, set "0" in any of DA₇, DAD through DAF of addresses 00₁₆ through EF₁₆, and of DAE and DAF of ad-

dresses F0₁₆ through F8₁₆.

Setting the blank code "FF₁₆" as a character code is an exception.

When using M35055-XXXFP, set "0" in any of DAD through DAF of addresses 00₁₆ through EF₁₆, and of DAE and DAF of addresses F0₁₆ through F8₁₆.

TEST_n (n : a number) is MITSUBISHI test memory, so be sure to observe the setting conditions.

Address	DA F	DA E	DA D	DA C	DA B	DA A	DA 9	DA 8	DA 7	DA 6	DA 5	DA 4	DA 3	DA 2	DA 1	DA 0
00 ₁₆	0	0	0	REV	BLINK	B	G	R	0	C6	C5	C4	C3	C2	C1	C0
⋮	⋮	⋮	⋮	⋮	⋮	Character color			⋮	Character code						
EF ₁₆	0	0	0	REV	BLINK	B	G	R	0	C6	C5	C4	C3	C2	C1	C0
F0 ₁₆	0	0	TEST15	TEST14	TEST13	TEST12	TEST11	TEST10	SYSEP1	SYSEP0	SEPV1	SEPV0	PTD1	PTD0	PTC1	PTC0
F1 ₁₆	0	0	TEST21	TEST20	TEST19	TEST18	TEST17	TEST16	HP7	HP6	HP5	HP4	HP3	HP2	HP1	HP0
F2 ₁₆	0	0	TEST27	TEST26	TEST25	TEST24	TEST23	TEST22	VP7	VP6	VP5	VP4	VP3	VP2	VP1	VP0
F3 ₁₆	0	0	TEST33	TEST32	TEST31	TEST30	TEST29	TEST28	VSZ21	VSZ20	VSZ11	VSZ10	HSZ21	HSZ20	HSZ11	HSZ10
F4 ₁₆	0	0	TEST36	TEST35	TEST34	SPACE	DSP9	DSP8	DSP7	DSP6	DSP5	DSP4	DSP3	DSP2	DSP1	DSP0
F5 ₁₆	0	0	TEST42	TEST41	TEST40	TEST39	TEST38	TEST37	EQP	PALH	MPAL	INT/NON	N/P	BLINK2	BLINK1	BLINK0
F6 ₁₆	0	0	TEST43	TEST2	TEST1	TEST0	LBLACK	LIN24/32	BLKHF	BB	BG	BR	LEVEL0	PHASE2	PHASE1	PHASE0
F7 ₁₆	0	0	TEST46	TEST45	RGBON	TEST44	CL17/18	CBLINK	CURS7	CURS6	CURS5	CURS4	CURS3	CURS2	CURS1	CURS0
F8 ₁₆	0	0	LEVEL1	TEST51	TEST50	TEST49	TEST48	TEST47	RAMERS	DSPON	STOP1	STOPIN	SCOR	EX	BLK1	BLK0

Fig. 1 Memory constitution (M35054-XXXFP)

Address	DA F	DA E	DA D	DA C	DA B	DA A	DA 9	DA 8	DA 7	DA 6	DA 5	DA 4	DA 3	DA 2	DA 1	DA 0
00 ₁₆	0	0	0	REV	BLINK	B	G	R	C7	C6	C5	C4	C3	C2	C1	C0
⋮	⋮	⋮	⋮	⋮	⋮	Character color			⋮	Character code						
EF ₁₆	0	0	0	REV	BLINK	B	G	R	C7	C6	C5	C4	C3	C2	C1	C0
F0 ₁₆	0	0	TEST15	TEST14	TEST13	TEST12	TEST11	TEST10	SYSEP1	SYSEP0	SEPV1	SEPV0	PTD1	PTD0	PTC1	PTC0
F1 ₁₆	0	0	TEST21	TEST20	TEST19	TEST18	TEST17	TEST16	HP7	HP6	HP5	HP4	HP3	HP2	HP1	HP0
F2 ₁₆	0	0	TEST27	TEST26	TEST25	TEST24	TEST23	TEST22	VP7	VP6	VP5	VP4	VP3	VP2	VP1	VP0
F3 ₁₆	0	0	TEST33	TEST32	TEST31	TEST30	TEST29	TEST28	VSZ21	VSZ20	VSZ11	VSZ10	HSZ21	HSZ20	HSZ11	HSZ10
F4 ₁₆	0	0	TEST36	TEST35	TEST34	SPACE	DSP9	DSP8	DSP7	DSP6	DSP5	DSP4	DSP3	DSP2	DSP1	DSP0
F5 ₁₆	0	0	TEST42	TEST41	TEST40	TEST39	TEST38	TEST37	EQP	PALH	MPAL	INT/NON	N/P	BLINK2	BLINK1	BLINK0
F6 ₁₆	0	0	TEST43	TEST2	TEST1	TEST0	LBLACK	LIN24/32	BLKHF	BB	BG	BR	LEVEL0	PHASE2	PHASE1	PHASE0
F7 ₁₆	0	0	TEST46	TEST45	RGBON	TEST44	CL17/18	CBLINK	CURS7	CURS6	CURS5	CURS4	CURS3	CURS2	CURS1	CURS0
F8 ₁₆	0	0	LEVEL1	TEST51	TEST50	TEST49	TEST48	TEST47	RAMERS	DSPON	STOP1	STOPIN	SCOR	EX	BLK1	BLK0

Fig. 2 Memory constitution (M35055-XXXFP)

M35054-XXXXFP/M35055-XXXXFP

SCREEN CHARACTER and PATTERN DISPLAY CONTROLLERS

SCREEN CONSTITUTION

The screen lines and rows are determined from each address of the display RAM. The screen constitution (24 characters X 10 lines) is shown in Figure 3 the screen constitution (32 characters X 7 lines) is shown in 4.

Rows Lines	1	2	3	4	5	6	7	8	9	10	11	12	13	14	15	16	17	18	19	20	21	22	23	24
1	00 ₁₆	01 ₁₆	02 ₁₆	03 ₁₆	04 ₁₆	05 ₁₆	06 ₁₆	07 ₁₆	08 ₁₆	09 ₁₆	0A ₁₆	0B ₁₆	0C ₁₆	0D ₁₆	0E ₁₆	0F ₁₆	10 ₁₆	11 ₁₆	12 ₁₆	13 ₁₆	14 ₁₆	15 ₁₆	16 ₁₆	17 ₁₆
2	18 ₁₆	19 ₁₆	1A ₁₆	1B ₁₆	1C ₁₆	1D ₁₆	1E ₁₆	1F ₁₆	20 ₁₆	21 ₁₆	22 ₁₆	23 ₁₆	24 ₁₆	25 ₁₆	26 ₁₆	27 ₁₆	28 ₁₆	29 ₁₆	2A ₁₆	2B ₁₆	2C ₁₆	2D ₁₆	2E ₁₆	2F ₁₆
3	30 ₁₆	31 ₁₆	32 ₁₆	33 ₁₆	34 ₁₆	35 ₁₆	36 ₁₆	37 ₁₆	38 ₁₆	39 ₁₆	3A ₁₆	3B ₁₆	3C ₁₆	3D ₁₆	3E ₁₆	3F ₁₆	40 ₁₆	41 ₁₆	42 ₁₆	43 ₁₆	44 ₁₆	45 ₁₆	46 ₁₆	47 ₁₆
4	48 ₁₆	49 ₁₆	4A ₁₆	4B ₁₆	4C ₁₆	4D ₁₆	4E ₁₆	4F ₁₆	50 ₁₆	51 ₁₆	52 ₁₆	53 ₁₆	54 ₁₆	55 ₁₆	56 ₁₆	57 ₁₆	58 ₁₆	59 ₁₆	5A ₁₆	5B ₁₆	5C ₁₆	5D ₁₆	5E ₁₆	5F ₁₆
5	60 ₁₆	61 ₁₆	62 ₁₆	63 ₁₆	64 ₁₆	65 ₁₆	66 ₁₆	67 ₁₆	68 ₁₆	69 ₁₆	6A ₁₆	6B ₁₆	6C ₁₆	6D ₁₆	6E ₁₆	6F ₁₆	70 ₁₆	71 ₁₆	72 ₁₆	73 ₁₆	74 ₁₆	75 ₁₆	76 ₁₆	77 ₁₆
6	78 ₁₆	79 ₁₆	7A ₁₆	7B ₁₆	7C ₁₆	7D ₁₆	7E ₁₆	7F ₁₆	80 ₁₆	81 ₁₆	82 ₁₆	83 ₁₆	84 ₁₆	85 ₁₆	86 ₁₆	87 ₁₆	88 ₁₆	89 ₁₆	8A ₁₆	8B ₁₆	8C ₁₆	8D ₁₆	8E ₁₆	8F ₁₆
7	90 ₁₆	91 ₁₆	92 ₁₆	93 ₁₆	94 ₁₆	95 ₁₆	96 ₁₆	97 ₁₆	98 ₁₆	99 ₁₆	9A ₁₆	9B ₁₆	9C ₁₆	9D ₁₆	9E ₁₆	9F ₁₆	A0 ₁₆	A1 ₁₆	A2 ₁₆	A3 ₁₆	A4 ₁₆	A5 ₁₆	A6 ₁₆	A7 ₁₆
8	A8 ₁₆	A9 ₁₆	AA ₁₆	AB ₁₆	AC ₁₆	AD ₁₆	AE ₁₆	AF ₁₆	B0 ₁₆	B1 ₁₆	B2 ₁₆	B3 ₁₆	B4 ₁₆	B5 ₁₆	B6 ₁₆	B7 ₁₆	B8 ₁₆	B9 ₁₆	BA ₁₆	BB ₁₆	BC ₁₆	BD ₁₆	BE ₁₆	BF ₁₆
9	C0 ₁₆	C1 ₁₆	C2 ₁₆	C3 ₁₆	C4 ₁₆	C5 ₁₆	C6 ₁₆	C7 ₁₆	C8 ₁₆	C9 ₁₆	CA ₁₆	CB ₁₆	CC ₁₆	CD ₁₆	CE ₁₆	CF ₁₆	D0 ₁₆	D1 ₁₆	D2 ₁₆	D3 ₁₆	D4 ₁₆	D5 ₁₆	D6 ₁₆	D7 ₁₆
10	D8 ₁₆	D9 ₁₆	DA ₁₆	DB ₁₆	DC ₁₆	DD ₁₆	DE ₁₆	DF ₁₆	E0 ₁₆	E1 ₁₆	E2 ₁₆	E3 ₁₆	E4 ₁₆	E5 ₁₆	E6 ₁₆	E7 ₁₆	E8 ₁₆	E9 ₁₆	EA ₁₆	EB ₁₆	EC ₁₆	ED ₁₆	EE ₁₆	EF ₁₆

Note : The hexadecimal numbers in the boxes show the display RAM address.

Fig. 3 Screen constitution (24 characters X 10 lines)

Rows Lines	1	2	3	4	5	6	7	8	9	10	11	12	13	14	15	16	17	18	19	20	21	22	23	24	25	26	27	28	29	30	31	32
1	00 ₁₆	01 ₁₆	02 ₁₆	03 ₁₆	04 ₁₆	05 ₁₆	06 ₁₆	07 ₁₆	08 ₁₆	09 ₁₆	0A ₁₆	0B ₁₆	0C ₁₆	0D ₁₆	0E ₁₆	0F ₁₆	10 ₁₆	11 ₁₆	12 ₁₆	13 ₁₆	14 ₁₆	15 ₁₆	16 ₁₆	17 ₁₆	18 ₁₆	19 ₁₆	1A ₁₆	1B ₁₆	1C ₁₆	1D ₁₆	1E ₁₆	1F ₁₆
2	20 ₁₆	21 ₁₆	22 ₁₆	23 ₁₆	24 ₁₆	25 ₁₆	26 ₁₆	27 ₁₆	28 ₁₆	29 ₁₆	2A ₁₆	2B ₁₆	2C ₁₆	2D ₁₆	2E ₁₆	2F ₁₆	30 ₁₆	31 ₁₆	32 ₁₆	33 ₁₆	34 ₁₆	35 ₁₆	36 ₁₆	37 ₁₆	38 ₁₆	39 ₁₆	3A ₁₆	3B ₁₆	3C ₁₆	3D ₁₆	3E ₁₆	3F ₁₆
3	40 ₁₆	41 ₁₆	42 ₁₆	43 ₁₆	44 ₁₆	45 ₁₆	46 ₁₆	47 ₁₆	48 ₁₆	49 ₁₆	4A ₁₆	4B ₁₆	4C ₁₆	4D ₁₆	4E ₁₆	4F ₁₆	50 ₁₆	51 ₁₆	52 ₁₆	53 ₁₆	54 ₁₆	55 ₁₆	56 ₁₆	57 ₁₆	58 ₁₆	59 ₁₆	5A ₁₆	5B ₁₆	5C ₁₆	5D ₁₆	5E ₁₆	5F ₁₆
4	60 ₁₆	61 ₁₆	62 ₁₆	63 ₁₆	64 ₁₆	65 ₁₆	66 ₁₆	67 ₁₆	68 ₁₆	69 ₁₆	6A ₁₆	6B ₁₆	6C ₁₆	6D ₁₆	6E ₁₆	6F ₁₆	70 ₁₆	71 ₁₆	72 ₁₆	73 ₁₆	74 ₁₆	75 ₁₆	76 ₁₆	77 ₁₆	78 ₁₆	79 ₁₆	7A ₁₆	7B ₁₆	7C ₁₆	7D ₁₆	7E ₁₆	7F ₁₆
5	80 ₁₆	81 ₁₆	82 ₁₆	83 ₁₆	84 ₁₆	85 ₁₆	86 ₁₆	87 ₁₆	88 ₁₆	89 ₁₆	8A ₁₆	8B ₁₆	8C ₁₆	8D ₁₆	8E ₁₆	8F ₁₆	90 ₁₆	91 ₁₆	92 ₁₆	93 ₁₆	94 ₁₆	95 ₁₆	96 ₁₆	97 ₁₆	98 ₁₆	99 ₁₆	9A ₁₆	9B ₁₆	9C ₁₆	9D ₁₆	9E ₁₆	9F ₁₆
6	A0 ₁₆	A1 ₁₆	A2 ₁₆	A3 ₁₆	A4 ₁₆	A5 ₁₆	A6 ₁₆	A7 ₁₆	A8 ₁₆	A9 ₁₆	AA ₁₆	AB ₁₆	AC ₁₆	AD ₁₆	AE ₁₆	AF ₁₆	B0 ₁₆	B1 ₁₆	B2 ₁₆	B3 ₁₆	B4 ₁₆	B5 ₁₆	B6 ₁₆	B7 ₁₆	B8 ₁₆	B9 ₁₆	BA ₁₆	BB ₁₆	BC ₁₆	BD ₁₆	BE ₁₆	BF ₁₆
7	C0 ₁₆	C1 ₁₆	C2 ₁₆	C3 ₁₆	C4 ₁₆	C5 ₁₆	C6 ₁₆	C7 ₁₆	C8 ₁₆	C9 ₁₆	CA ₁₆	CB ₁₆	CC ₁₆	CD ₁₆	CE ₁₆	CF ₁₆	D0 ₁₆	D1 ₁₆	D2 ₁₆	D3 ₁₆	D4 ₁₆	D5 ₁₆	D6 ₁₆	D7 ₁₆	D8 ₁₆	D9 ₁₆	DA ₁₆	DB ₁₆	DC ₁₆	DD ₁₆	DE ₁₆	DF ₁₆

Notes 1. The hexadecimal numbers in the boxes show the display RAM address.
2. When 32 characters X 7 lines are displayed, set blank code "FF₁₆" to character code of addresses E0₁₆ to EF₁₆.

Fig. 4 Screen constitution (32 characters X 7 lines)

Display RAM DESCRIPTION

Display RAM Address 0016 to EF16

DA 0-C	Name	Contents		Remarks		
		Status	Function			
0	C0 (LSB)	0	Set ROM-held character code of a character needed to display.			
		①				
1	C1	0				
		①				
2	C2	0				
		①				
3	C3	0				
		①				
4	C4	0				
		①				
5	C5	0				
		①				
6	C6 (MSB)	0				
		①				
7	—	0			Set to "0" during normal operation	(Note 2)
		①			Can not be used	
8	R	0	When RGBON=1, set background color by character unit.	Refer to supplemental explanation (3).		
		①				
9	G	0				
		①				
A	B	0				
		①				
B	BLINK	0	No blinking	Refer to BLINK2 to 0 (address F516)		
		①	Blinking			
C	REV	①	Normal character			
		1	Reversed character			

Notes 1. Resetting at the \bar{AC} pin RAM-erases the display RAM, and the status turns as indicated by the mark ○ around in the status column.
 2. Set to "1" only when setting a blank code. When using M35055-XXXFP, DA7 is C7 (MSB).

Display control register

(1) Address F016

DA 0-D	Register	Contents			Remarks																
		Status	Function																		
0	PTC0	0	P0 output (port 0)		Port output control																
		1	BLNK1 output																		
1	PTC1	0	P1 output (port 1)		Refer to supplemental explanation (4).																
		1	CO1 output																		
2	PTD0	0	It is negative polarity at P0 output "L", BLINK1 output.		Control the port data																
		1	It is positive polarity at P0 output "H", BLINK1 output.																		
3	PTD1	0	It is negative polarity at P01 output "L", CO1 output.		Refer to supplemental explanation (4).																
		1	It is positive polarity at P01 output "H", CO1 output.																		
4	SEPV0	0	It should be fixed to "0".		Specifies the vertical synchronous separation criterion																
		1	Can not be used.																		
5	SEPV1	0	It should be fixed to "0".		Refer to supplemental explanation (1).																
		1	Can not be used.																		
6	SYSEP0	0	<table border="1"> <thead> <tr> <th>SYSEP1</th> <th>SYSEP0</th> <th>Bias potential</th> </tr> </thead> <tbody> <tr> <td>0</td> <td>0</td> <td>Can not be used.</td> </tr> <tr> <td>0</td> <td>1</td> <td>Can not be used.</td> </tr> <tr> <td>1</td> <td>0</td> <td>1.75V</td> </tr> <tr> <td>1</td> <td>1</td> <td>Can not be used.</td> </tr> </tbody> </table>			SYSEP1	SYSEP0	Bias potential	0	0	Can not be used.	0	1	Can not be used.	1	0	1.75V	1	1	Can not be used.	Specifies the sync-bias potential
		SYSEP1	SYSEP0	Bias potential																	
0	0	Can not be used.																			
0	1	Can not be used.																			
1	0	1.75V																			
1	1	Can not be used.																			
1																					
7	SYSEP1	0																			
		1																			
8	TEST10	0	It should be fixed to "0".																		
		1	Can not be used.																		
9	TEST11	0	It should be fixed to "0".																		
		1	Can not be used.																		
A	TEST12	0	Can not be used.																		
		1	It should be fixed to "1".																		
B	TEST13	0	It should be fixed to "0".																		
		1	Can not be used.																		
C	TEST14	0	It should be fixed to "0".																		
		1	Can not be used.																		
D	TEST15	0	It should be fixed to "0".																		
		1	Can not be used.																		

Note: The mark ○ around the status value means the reset status by the "L" level is input to \overline{AC} pin.

M35054-XXXFP/M35055-XXXFP

SCREEN CHARACTER and PATTERN DISPLAY CONTROLLERS

(2) Address F116

DA 0~D	Register	Contents		Remarks
		Status	Function	
0	HP0 (LSB)	0	Let horizontal display start position be HS, $HS = T \times \left(\sum_{n=0}^7 2^n HP_n + 6 \right)$ <p>T : The oscillation cycle of display clock</p>	Set the horizontal display start position by use of HP7 through HP0. HP7 to HP0 = (00000000) to (00001111) setting is forbidden. It can be set this up to 240 steps in increments of one T.
		1		
1	HP1	0		
		1		
2	HP2	0		
		1		
3	HP3	0		
		1		
4	HP4	0		
		1		
5	HP5	0		
		1		
6	HP6	0		
		1		
7	HP7 (MSB)	0		
		1		
8	TEST16	0	Can not be used.	
		1	It should be fixed to "1".	
9	TEST17	0	Can not be used.	
		1	It should be fixed to "1".	
A	TEST18	0	Can not be used.	
		1	It should be fixed to "1".	
B	TEST19	0	Can not be used.	
		1	It should be fixed to "1".	
C	TEST20	0	Can not be used.	
		1	It should be fixed to "1".	
D	TEST21	0	It should be fixed to "0".	
		1	Can not be used.	

M35054-XXXFP/M35055-XXXFP

SCREEN CHARACTER and PATTERN DISPLAY CONTROLLERS

(3) Address F216

DA 0~D	Register	Contents		Remarks
		Status	Function	
0	VP0 (LSB)	0	Let vertical display start position be VS, $VS = H \times \sum_{n=0}^7 2^n VP_n$ <p>H : The oscillation cycle of horizontal synchronous signal</p>	Set the vertical display start position by use of VP7 through VP0. VP7 to VP0 = (00000000) to (00000110) setting is forbidden. It can be set this up to 249 steps in increments of one H. VP7 to VP0 = (00000000) to (00100011) setting is forbidden.
		1		
1	VP1	0		
		1		
2	VP2	0		
		1		
3	VP3	0		
		1		
4	VP4	0		
		1		
5	VP5	0		
		1		
6	VP6	0		
		1		
7	VP7 (MSB)	0		
		1		
8	TEST22	0	Can not be used.	
		1	It should be fixed to "1".	
9	TEST23	0	Can not be used.	
		1	It should be fixed to "1".	
A	TEST24	0	Can not be used.	
		1	It should be fixed to "1".	
B	TEST25	0	Can not be used.	
		1	It should be fixed to "1".	
C	TEST26	0	Can not be used.	
		1	It should be fixed to "1".	
D	TEST27	0	It should be fixed to "0".	
		1	Can not be used.	

M35054-XXXXFP/M35055-XXXXFP

SCREEN CHARACTER and PATTERN DISPLAY CONTROLLERS

(4) Address F316

DA 0~D	Register	Contents			Remarks		
		Status	Function				
0	HSZ10	0	HSZ11	HSZ10	Horizontal direction size	Character size setting in the horizontal direction for the first line.	
		1					0
1	HSZ11	0	0	1	2T/dot		
		1	1	0	3T/dot		
2	HSZ20	0	0	1	4T/dot		
		1	1	1			
3	HSZ21	0	HSZ21	HSZ20	Horizontal direction size		Character size setting in the horizontal direction for the 2nd line to 10th line.
		1					
4	VSZ10	0	0	1	2T/dot		
		1	1	0	3T/dot		
5	VSZ11	0	0	1	4T/dot		
		1	1	1			
6	VSZ20	0	VSZ21	VSZ20	Vertical direction size	Character size setting in the vertical direction for the 2nd line to 10th line.	
		1					
7	VSZ21	0	0	1	2H/dot		
		1	1	0	3H/dot		
8	TEST28	0	It should be fixed to "0".				
		1	Can not be used.				
9	TEST29	0	It should be fixed to "0".				
		1	Can not be used.				
A	TEST30	0	It should be fixed to "0".				
		1	Can not be used.				
B	TEST31	0	It should be fixed to "0".				
		1	Can not be used.				
C	TEST32	0	It should be fixed to "0".				
		1	Can not be used.				
D	TEST33	0	It should be fixed to "0".				
		1	Can not be used.				

M35054-XXXXFP/M35055-XXXXFP

SCREEN CHARACTER and PATTERN DISPLAY CONTROLLERS

(5) Address F416

DA 0~D	Register	Contents		Remarks																				
		Status	Function																					
0	DSP0	0	<table border="1" style="margin-left: 20px;"> <thead> <tr> <th>BLK1</th> <th>BLK0</th> <th>DSPn= "1"</th> <th>DSPn= "0"</th> </tr> </thead> <tbody> <tr> <td>0</td> <td>0</td> <td>Matrix-outline border size</td> <td>Matrix-outline size</td> </tr> <tr> <td>0</td> <td>1</td> <td>Border size</td> <td>Character size</td> </tr> <tr> <td>1</td> <td>0</td> <td>Matrix-outline size</td> <td>Border size</td> </tr> <tr> <td>1</td> <td>1</td> <td>Character size</td> <td>Matrix-outline size</td> </tr> </tbody> </table> <p>Depends on BLK0 and BLK1 (address F816) DSPn in the generic name for DSP0 to DSP9. DSP0 to DSP9 are each controlled independently.</p>	BLK1	BLK0	DSPn= "1"	DSPn= "0"	0	0	Matrix-outline border size	Matrix-outline size	0	1	Border size	Character size	1	0	Matrix-outline size	Border size	1	1	Character size	Matrix-outline size	Set the display mode of line 1.
		BLK1		BLK0	DSPn= "1"	DSPn= "0"																		
0	0	Matrix-outline border size		Matrix-outline size																				
0	1	Border size		Character size																				
1	0	Matrix-outline size		Border size																				
1	1	Character size		Matrix-outline size																				
1	DSP1	1		Set the display mode of line 2.																				
2	DSP2	0		Set the display mode of line 3.																				
		1		Set the display mode of line 4.																				
3	DSP3	0		Set the display mode of line 5.																				
		1	Set the display mode of line 6.																					
4	DSP4	0	Set the display mode of line 7.																					
		1	Set the display mode of line 8.																					
5	DSP5	0	Set the display mode of line 9.																					
		1	Set the display mode of line 10.																					
6	DSP6	0	Normal display																					
		1	Put a space line between line 2 and line 3, and between line 8 and line 9.																					
7	DSP7	0	It should be fixed to "0".																					
		1	Can not be used.																					
8	DSP8	0	It should be fixed to "0".																					
		1	Can not be used.																					
9	DSP9	0	It should be fixed to "0".																					
		1	Can not be used.																					
A	SPACE	0	Put a space line between line 2 and line 3, and between line 8 and line 9.																					
		1	Put a space line between line 2 and line 3, and between line 8 and line 9.																					
B	TEST34	0	It should be fixed to "0".																					
		1	Can not be used.																					
C	TEST35	0	It should be fixed to "0".																					
		1	Can not be used.																					
D	TEST36	0	It should be fixed to "0".																					
		1	Can not be used.																					

M35054-XXXFP/M35055-XXXFP

SCREEN CHARACTER and PATTERN DISPLAY CONTROLLERS

(6) Address F516

DA 0~D	Register	Contents			Remarks															
		Status	Function																	
0	BLINK0	0	<table border="1"> <thead> <tr> <th>BLINK0</th> <th>BLINK1</th> <th>Duty</th> </tr> </thead> <tbody> <tr> <td>0</td> <td>0</td> <td>Blinking off</td> </tr> <tr> <td>0</td> <td>1</td> <td>25%</td> </tr> <tr> <td>1</td> <td>0</td> <td>50%</td> </tr> <tr> <td>1</td> <td>1</td> <td>75%</td> </tr> </tbody> </table>		BLINK0	BLINK1	Duty	0	0	Blinking off	0	1	25%	1	0	50%	1	1	75%	Blinking duty ratio can be altered. (Note)
		BLINK0	BLINK1	Duty																
0	0	Blinking off																		
0	1	25%																		
1	0	50%																		
1	1	75%																		
1																				
1	BLINK1	0																		
		1																		
2	BLINK2	0	Division of vertical synchronizing signal into 1/64. Cycle approximately 1 second.		Blinking cycle can be altered.															
		1	Division of vertical synchronizing signal into 1/32. Cycle approximately 0.5 second.																	
3	N/P	0	NTSC, M-PAL mode		Refer to register MPAL															
		1	PAL mode																	
4	INT/NON	0	Interlace		Scanning lines control (only in internal synchronization)															
		1	Non interlace																	
5	MPAL	0	<table border="1"> <thead> <tr> <th>N/P</th> <th>MPAL</th> <th>Synchronous mode</th> </tr> </thead> <tbody> <tr> <td>0</td> <td>0</td> <td>NTSC</td> </tr> <tr> <td>0</td> <td>1</td> <td>M-PAL</td> </tr> <tr> <td>1</td> <td>0</td> <td>PAL</td> </tr> <tr> <td>1</td> <td>1</td> <td>Not available</td> </tr> </tbody> </table>		N/P	MPAL	Synchronous mode	0	0	NTSC	0	1	M-PAL	1	0	PAL	1	1	Not available	Synchronizing signal is selected with this register and N/P register.
		N/P	MPAL	Synchronous mode																
0	0	NTSC																		
0	1	M-PAL																		
1	0	PAL																		
1	1	Not available																		
1																				
6	PALH	0	<table border="1"> <thead> <tr> <th>PALH</th> <th>INT/NON</th> <th>Number of scanning lines</th> </tr> </thead> <tbody> <tr> <td rowspan="2">0</td> <td>0</td> <td>625H lines</td> </tr> <tr> <td>1</td> <td>626H lines</td> </tr> <tr> <td rowspan="2">1</td> <td>0</td> <td>627H lines</td> </tr> <tr> <td>1</td> <td>628H lines</td> </tr> </tbody> </table>		PALH	INT/NON	Number of scanning lines	0	0	625H lines	1	626H lines	1	0	627H lines	1	628H lines	It should be fixed to "0" at NTSC		
		PALH	INT/NON	Number of scanning lines																
0	0	625H lines																		
	1	626H lines																		
1	0	627H lines																		
	1	628H lines																		
1																				
7	EQP	0	Not include the equivalent pulse.		Effective only at non-interlace															
		1	Include the equivalent pulse.																	
8	TEST37	0	It should be fixed to "0".																	
		1	Can not be used.																	
9	TEST38	0	It should be fixed to "0".																	
		1	Can not be used.																	
A	TEST39	0	It should be fixed to "0".																	
		1	Can not be used.																	
B	TEST40	0	It should be fixed to "0".																	
		1	Can not be used.																	
C	TEST41	0	It should be fixed to "0".																	
		1	Can not be used.																	
D	TEST42	0	It should be fixed to "0".																	
		1	Can not be used.																	

Note. To blink a character, set 1 to DAB (the blinking bit) of the display RAM.

M35054-XXXFP/M35055-XXXFP

SCREEN CHARACTER and PATTERN DISPLAY CONTROLLERS

(7) Address F616

DA 0~D	Register	Contents				Remarks																																					
		Status	Function																																								
0	PHASE0	①	<table border="1"> <thead> <tr> <th>PHASE2</th> <th>PHASE1</th> <th>PHASE0</th> <th>Raster</th> </tr> </thead> <tbody> <tr><td>0</td><td>0</td><td>0</td><td>Black</td></tr> <tr><td>0</td><td>0</td><td>1</td><td>Red</td></tr> <tr><td>0</td><td>1</td><td>0</td><td>Green</td></tr> <tr><td>0</td><td>1</td><td>1</td><td>Yellow</td></tr> <tr><td>1</td><td>0</td><td>0</td><td>Blue</td></tr> <tr><td>1</td><td>0</td><td>1</td><td>Magenta</td></tr> <tr><td>1</td><td>1</td><td>0</td><td>Cyan</td></tr> <tr><td>1</td><td>1</td><td>1</td><td>White</td></tr> </tbody> </table>				PHASE2	PHASE1	PHASE0	Raster	0	0	0	Black	0	0	1	Red	0	1	0	Green	0	1	1	Yellow	1	0	0	Blue	1	0	1	Magenta	1	1	0	Cyan	1	1	1	White	Raster color setting Refer to supplemental explanation (2) about video signal level
		PHASE2					PHASE1	PHASE0	Raster																																		
0	0	0					Black																																				
0	0	1					Red																																				
0	1	0					Green																																				
0	1	1					Yellow																																				
1	0	0					Blue																																				
1	0	1					Magenta																																				
1	1	0					Cyan																																				
1	1	1					White																																				
1																																											
1	PHASE1	①																																									
		1																																									
2	PHASE2	①																																									
		1																																									
3	LEVEL0	①	Internal bias off			Generates bias potential for composite video signals																																					
		1	Internal bias on																																								
4	BR	①	<table border="1"> <thead> <tr> <th>BB</th> <th>BG</th> <th>BR</th> <th>Character back-ground color</th> </tr> </thead> <tbody> <tr><td>0</td><td>0</td><td>0</td><td>Black</td></tr> <tr><td>0</td><td>0</td><td>1</td><td>Red</td></tr> <tr><td>0</td><td>1</td><td>0</td><td>Green</td></tr> <tr><td>0</td><td>1</td><td>1</td><td>Yellow</td></tr> <tr><td>1</td><td>0</td><td>0</td><td>Blue</td></tr> <tr><td>1</td><td>0</td><td>1</td><td>Magenta</td></tr> <tr><td>1</td><td>1</td><td>0</td><td>Cyan</td></tr> <tr><td>1</td><td>1</td><td>1</td><td>White</td></tr> </tbody> </table>				BB	BG	BR	Character back-ground color	0	0	0	Black	0	0	1	Red	0	1	0	Green	0	1	1	Yellow	1	0	0	Blue	1	0	1	Magenta	1	1	0	Cyan	1	1	1	White	Character background color setting. Refer to supplemental explanation (2) about video signal level
		BB					BG	BR	Character back-ground color																																		
0	0	0					Black																																				
0	0	1					Red																																				
0	1	0					Green																																				
0	1	1					Yellow																																				
1	0	0					Blue																																				
1	0	1					Magenta																																				
1	1	0					Cyan																																				
1	1	1					White																																				
1																																											
5	BG	①																																									
		1																																									
6	BB	①																																									
		1																																									
7	BLKHF	①	The halftone displaying "OFF" in superimpose			This register is available in the superimpose displaying only. (Note)																																					
		1	The halftone displaying "ON" in superimpose																																								
8	LIN $\overline{24}$ /32	①	24 characters X 10 lines display																																								
		1	32 characters X 7 lines display																																								
9	LBLACK	①	Blanking level I 2.3V			Set a blackness level																																					
		1	Blanking level II 2.1V																																								
A	TEST0	①	It should be fixed to "0".																																								
		1	Can not be used.																																								
B	TEST1	①	It should be fixed to "0".																																								
		1	Can not be used.																																								
C	TEST2	①	It should be fixed to "0".																																								
		1	Can not be used.																																								
D	TEST43	①	Can not be used.																																								
		1	It should to be fixed to "1".																																								

Note. It is necessary to input the external composite video signal to the CVIN pin, and externally connect a 100 to 200Ω register in series.

M35054-XXXFP/M35055-XXXFP

SCREEN CHARACTER and PATTERN DISPLAY CONTROLLERS

(8) Address F716

DA 0~D	Register	Contents		Remarks
		Status	Function	
0	CUR0	0	Let cursor displaying address be CURS, $\text{CURS} = \sum_{n=0}^7 2^n \text{CURn}$	Set the cursor displaying address by use of CUR7 through CUR0. CUR7 to CUR0 (11110000) setting is forbidden under 24 characters display. CUR7 to CUR0 (11100000) setting is forbidden under 32 characters display. Set CUR7 to CUR0 = (11111111) under cursor is not be displayed. The cursor displaying address (CURS) is correspond to display construction.
		1		
1	CUR1	0		
		1		
2	CUR2	0		
		1		
3	CUR3	0		
		1		
4	CUR4	0		
		1		
5	CUR5	0		
		1		
6	CUR6	0		
		1		
7	CUR7	0		
		1		
8	CBLINK	0	No blinking	The cursor blinking setting
		1	Blinking	
9	CL17/18	0	Cursor displaying at the 17th dot by vertical direction.	Refer to character construction.
		1	Cursor displaying at the 18th dot by vertical direction.	
A	TEST44	0	It should be fixed to "0".	
		1	Can not be used.	
B	RGBON	0	Normal	Refer to supplemental explanation (3).
		1	Character background coloring	
C	TEST45	0	It should be fixed to "0".	
		1	Can not be used.	
D	TEST46	0	It should be fixed to "0".	
		1	Can not be used.	

M35054-XXXFP/M35055-XXXFP

SCREEN CHARACTER and PATTERN DISPLAY CONTROLLERS

(9) Address F816

DA 0~D	Register	Contents				Remarks																				
		Status	Function																							
0	BLK0	①	<table border="1"> <tr> <td>BLK1</td> <td>BLK0</td> <td>DSPn= "1"</td> <td>DSPn= "0"</td> </tr> <tr> <td>0</td> <td>0</td> <td>Matrix-outline border size</td> <td>Matrix-outline size</td> </tr> <tr> <td>0</td> <td>1</td> <td>Border size</td> <td>Character size</td> </tr> <tr> <td>1</td> <td>0</td> <td>Matrix-outline size</td> <td>Border size</td> </tr> <tr> <td>1</td> <td>1</td> <td>Character size</td> <td>Matrix-outline size</td> </tr> </table>			BLK1	BLK0	DSPn= "1"	DSPn= "0"	0	0	Matrix-outline border size	Matrix-outline size	0	1	Border size	Character size	1	0	Matrix-outline size	Border size	1	1	Character size	Matrix-outline size	Display mode (BLNK output) variable
		BLK1				BLK0	DSPn= "1"	DSPn= "0"																		
0	0	Matrix-outline border size	Matrix-outline size																							
0	1	Border size	Character size																							
1	0	Matrix-outline size	Border size																							
1	1	Character size	Matrix-outline size																							
1																										
1	BLK1	①	<table border="1"> <tr> <td>BLK1</td> <td>BLK0</td> <td>DSPn= "1"</td> <td>DSPn= "0"</td> </tr> <tr> <td>0</td> <td>0</td> <td>Matrix-outline border size</td> <td>Matrix-outline size</td> </tr> <tr> <td>0</td> <td>1</td> <td>Border size</td> <td>Character size</td> </tr> <tr> <td>1</td> <td>0</td> <td>Matrix-outline size</td> <td>Border size</td> </tr> <tr> <td>1</td> <td>1</td> <td>Character size</td> <td>Matrix-outline size</td> </tr> </table>			BLK1	BLK0	DSPn= "1"	DSPn= "0"	0	0	Matrix-outline border size	Matrix-outline size	0	1	Border size	Character size	1	0	Matrix-outline size	Border size	1	1	Character size	Matrix-outline size	Display mode (BLNK output) variable
		BLK1				BLK0	DSPn= "1"	DSPn= "0"																		
0	0	Matrix-outline border size	Matrix-outline size																							
0	1	Border size	Character size																							
1	0	Matrix-outline size	Border size																							
1	1	Character size	Matrix-outline size																							
1																										
2	EX	①	External synchronization			Synchronizing signal switching (Note1)																				
		1	Internal synchronization																							
3	SCOR	①	Superimpose monotone display			"1" setting is forbidden at internal synchronous or PAL, M-PAL mode displaying.																				
		1	Superimpose coloring display (only NTSC)																							
4	STOPIN	①	fsc input mode			OSCIN oscillation control																				
		1	Can not be used.																							
5	STOP1	①	Oscillation VCO for display			Control oscillation VCO for display																				
		1	Stop oscillation VCO for display																							
6	DSPON	①	Display OFF																							
		1	Display ON																							
7	RAMERS	①	RAM not erased			This register does not exist (Note 3).																				
		1	RAM erased																							
8	TEST47	①	Can not be used.																							
		1	It should be fixed to "1".																							
9	TEST48	①	Can not be used.																							
		1	It should be fixed to "1".																							
A	TEST49	①	Can not be used.																							
		1	It should be fixed to "1".																							
B	TEST50	①	Can not be used.																							
		1	It should be fixed to "1".																							
C	TEST51	①	Can not be used.																							
		1	It should be fixed to "1".																							
D	LEVEL1	①	Internal bias OFF			Generates bias potential for synchronous separation.																				
		1	Internal bias ON																							

- Notes 1.** In dealing with the internal synchronization, cut off external video signals outside the IC. The leakage of external input video signals can be avoided.
- 2.** In displaying color superimposition, enter into the OSCIN pin the fsc signal that phase-synchronizes with the color burst of the composite video signals (input to the CVIN pin).
- 3.** Erases all the display RAM. The character code turns to blank-FF16, the encode data bit and the blinking bit turn to "1" respectively, and reversed character bit turns to "0".

Supplemental explanation about display control register

(1) How to effect synchronous separation from composite video signals

Synchronous separation is effected as follows depending on the width of L-level of the vertical synchronous period.

1. Less than $8.4\mu\text{s}$ Not to be determined to be a vertical synchronous signal.
2. Equal to or higher than $8.4\mu\text{s}$ but less than $15.6\mu\text{s}$ When two clocks continue, if take place, it is "L" period is determined to be a vertical synchronization signal.
3. Equal to or higher than $15.6\mu\text{s}$ It is "L" period is determined to be a vertical synchronous signal with no condition.

The determination is made at the timing indicated by V in Fig.4 either in case 2 or in case 3.

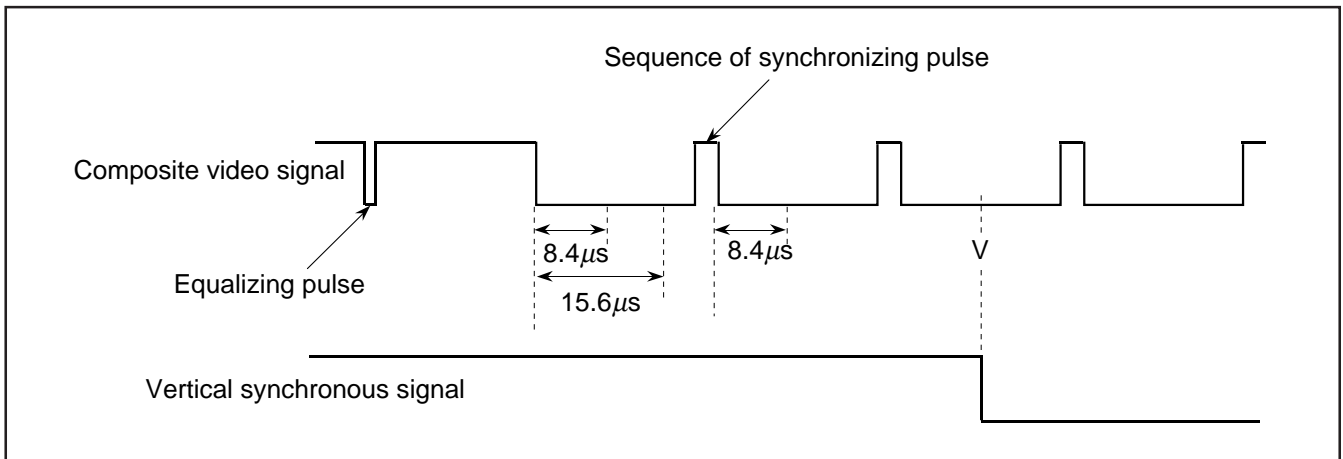

Fig. 5 The method of synchronous separation from composite video signal.

(2) Video signal level

VDD : 5.0V, Ta : 25°C

Color	Phase angle (rad)		Brightness level (V)			Amplitude ratio (to color burst)		
	NTSC method	PAL, M-PAL method	Min.	Typ.	Max.	Min.	Typ.	Max.
Sync-chip	—	—	1.3	1.5	1.7	—	—	—
Pedestal	—	—	1.9	2.1	2.3	—	—	—
Color burst	0	$\pm 4\pi/16$	1.9	2.1	2.3	—	1.0	—
Black	—	—	2.1	2.3	2.5	—	—	—
Red	$7\pi/16 \pm 2\pi/16$	$\pm 7\pi/16 \pm 2\pi/16$	2.3	2.5	2.7	1.5	3.0	4.5
Green	$27\pi/16 \pm 2\pi/16$	$\mp 5\pi/16 \pm 2\pi/16$	2.7	2.9	3.1	1.4	2.8	4.2
Yellow	$\pi/16 \pm 2\pi/16$	$\pm \pi/16 \pm 2\pi/16$	3.1	3.3	3.5	1.0	2.0	3.0
Blue	$17\pi/16 \pm 2\pi/16$	$\mp 15\pi/16 \pm 2\pi/16$	2.0	2.2	2.4	1.0	2.0	3.0
Magenta	$11\pi/16 \pm 2\pi/16$	$\pm 11\pi/16 \pm 2\pi/16$	2.5	2.7	2.9	1.4	2.8	4.2
Cyan	$23\pi/16 \pm 2\pi/16$	$\mp 9\pi/16 \pm 2\pi/16$	2.9	3.1	3.3	1.5	3.0	4.5
White	—	—	3.1	3.3	3.5	—	—	—

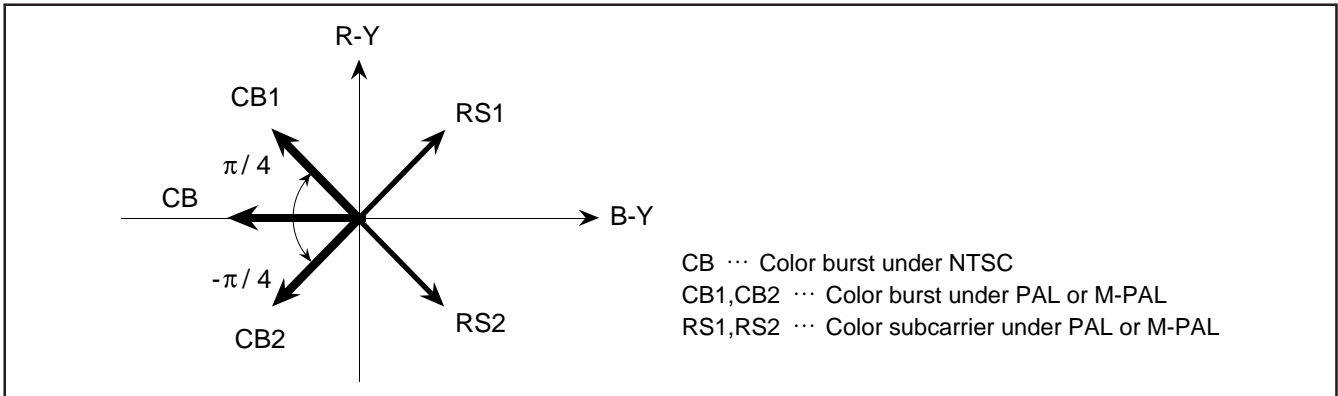

Fig. 6 Bector phases

(3) Setting RGBON (address F716)

RGBON = "0" Sets background colors depending on BB, BG, and BR (address F616), screen by screen.

RGBON = "1" Sets background colors depending on R, G, B (address 0016 to EF16), character by character. The color setting is shown below.

Color Setting

B	G	R	Color
0	0	0	Black
0	0	1	Red
0	1	0	Green
0	1	1	Yellow
1	0	0	Blue
1	0	1	Magenta
1	1	0	Cyan
1	1	1	White

(4) Port output and BLNK1, CO1 output

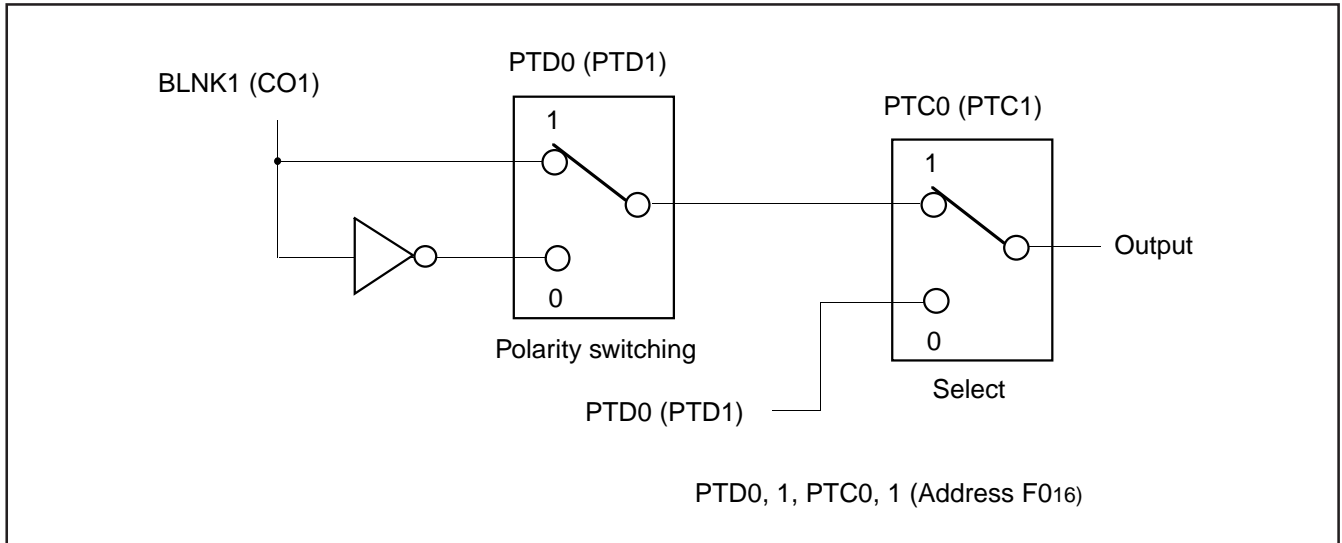

Fig. 7 Example of port control

(5) Setting conditions for oscillating or stopping the display clock

	at display clock operating	at display clock stop
STOP1	0	1
DSPON	1	0
CS pin	L	H

STOP1, CDSPON (Address F816)

(6) Setting condition at LEVEL0,1

	Operation state (Character display)		Now-working condition (no characters are displayed)
	Internal synchronous	External synchronous	
LEVEL0	1	1	0
LEVEL1	0	1	0

LEVEL0 (address F616), LEVEL1 (address F816)

DISPLAY FORMS

M35054-XXXFP/M35055-XXXFP have the following four display forms as the blanking function, when CO1 and BLNK1 are output.

- (1) Character size : Blanking same as the character size.
- (2) Border size : Blanking the background as a size from character.
- (3) Matrix-outline size: Blanking the background as a size from all character font size.
- (4) Matrix-outline border size : Blanking the background as a size from all character font size.
Border display.

This display format allows each line to be controlled independently, so that two kinds of display formats can be combined on the same screen.

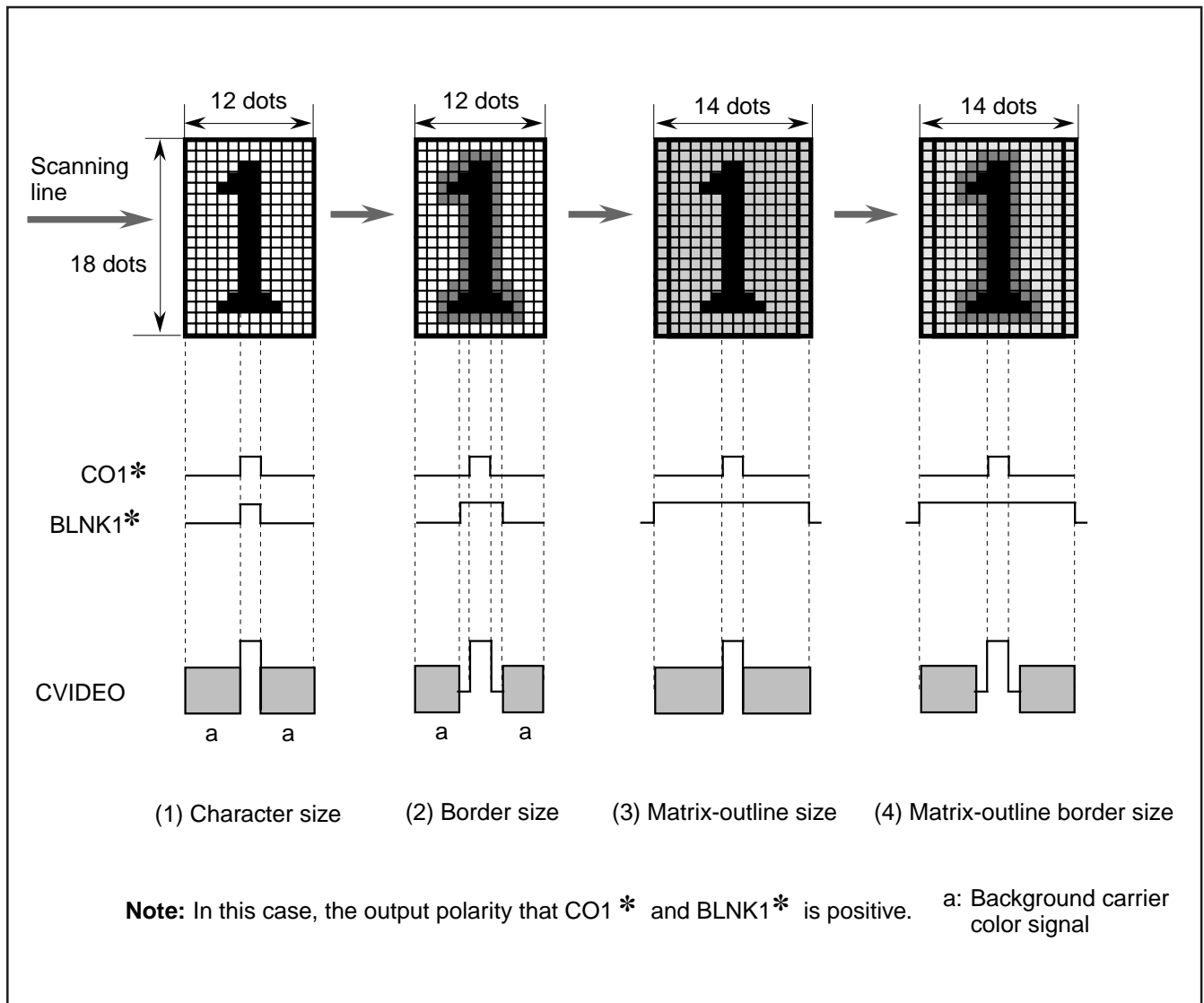

Fig. 8 Display forms at each display mode

M35054-XXXXP/M35055-XXXXP

SCREEN CHARACTER and PATTERN DISPLAY CONTROLLERS

DATA INPUT EXAMPLE

Data of display RAM and display control registers can be set by then serial input function.

Owing to automatic address increment, not necessary to enter addresses for the second and subsequent data.

In automatically, the next of address F8₁₆ is assigned to address 00₁₆.

Fig. 9 shows an example of data setting by the serial input function (M35054-XXXXP), Fig. 10 shows an example of data setting by the serial input function (M35055-XXXXP).

NO.	Data contents		DA	DA	DA	DA	DA	DA	DA	DA	DA	DA	DA	DA	DA	DA	DA	
	Address/Data	Supplemental explanation	F	E	D	C	B	A	9	8	7	6	5	4	3	2	1	0
1	Address(F8 ₁₆)	Address setting	0	0	0	0	0	0	0	0	1	1	1	1	1	0	0	0
2	Data(F8 ₁₆)	Display OFF	0	0	0	0	0	0	0	0	0	0	0	0	0	0	0	0
3	Data(00 ₁₆)	Display RAM address 00 ₁₆ to EF ₁₆ setting	0	0	0	REV	BLINK	B	G	R	0	C6	C5	C4	C3	C2	C1	C0
4	Data(01 ₁₆)		0	0	0	REV	BLINK	B	G	R	0	C6	C5	C4	C3	C2	C1	C0
⋮	⋮		⋮	⋮	⋮	⋮	⋮	⋮	⋮	⋮	⋮	⋮	⋮	⋮	⋮	⋮	⋮	⋮
241	Data(EE ₁₆)		0	0	0	REV	BLINK	B	G	R	0	C6	C5	C4	C3	C2	C1	C0
242	Data(EF ₁₆)		0	0	0	REV	BLINK	B	G	R	0	C6	C5	C4	C3	C2	C1	C0
243	Data(F0 ₁₆)	Register address F0 ₁₆ to F7 ₁₆ setting	0	0	0	0	0	1	0	0	1	0	0	0	PTD ₁	PTD ₀	PTC ₁	PTC ₀
244	Data(F1 ₁₆)		0	0	0	1	1	1	1	1	HP ₇	HP ₆	HP ₅	HP ₄	HP ₃	HP ₂	HP ₁	HP ₀
245	Data(F2 ₁₆)		0	0	0	1	1	1	1	1	VP ₇	VP ₆	VP ₅	VP ₄	VP ₃	VP ₂	VP ₁	VP ₀
246	Data(F3 ₁₆)		0	0	0	0	0	0	0	0	VSZ ₂₁	VSZ ₂₀	VSZ ₁₁	VSZ ₁₀	HSZ ₂₁	HSZ ₂₀	HSZ ₁₁	HSZ ₁₀
247	Data(F4 ₁₆)		0	0	0	0	0	SPACE	DSP ₉	DSP ₈	DSP ₇	DSP ₆	DSP ₅	DSP ₄	DSP ₃	DSP ₂	DSP ₁	DSP ₀
248	Data(F5 ₁₆)		0	0	0	0	0	0	0	0	EQP	PALH	MPAL	INT/NON	N/P	BLINK ₂	BLINK ₁	BLINK ₀
249	Data(F6 ₁₆)		0	0	1	TEST ₂	TEST ₁	TEST ₀	LBLACK	LIN _{24/32}	BLKHF	BB	BG	BR	LEVEL ₀	PHASE ₂	PHASE ₁	PHASE ₀
250	Data(F7 ₁₆)		0	0	0	0	RGBON	0	CL _{17/18}	CBLINK	CURS ₇	CURS ₆	CURS ₅	CURS ₄	CURS ₃	CURS ₂	CURS ₁	CURS ₀
251	Data(F8 ₁₆)	Display ON	0	0	LEVEL ₁	1	1	1	1	1	RAM _{ERS}	DSPON	STOP ₁	STOP _{IN}	SCOR	EX	BLK ₁	BLK ₀

Fig. 9 Example of data setting by the serial input function (M35054-XXXXP)

M35054-XXXXFP/M35055-XXXXFP

SCREEN CHARACTER and PATTERN DISPLAY CONTROLLERS

NO.	Data couteuts		DA	DA	DA	DA	DA	DA	DA	DA	DA	DA	DA	DA	DA	DA	DA		
	Address/Data	Supplemental explanation	F	E	D	C	B	A	9	8	7	6	5	4	3	2	1	0	
1	Address(F8 ₁₆)	Address setting	0	0	0	0	0	0	0	0	1	1	1	1	1	0	0	0	
2	Data(F8 ₁₆)	Display OFF	0	0	0	0	0	0	0	0	0	0	0	0	0	0	0	0	
3	Data(00 ₁₆)	Display RAM address 00 ₁₆ to EF ₁₆ setting	0	0	0	REV	BLINK	B	G	R	C7	C6	C5	C4	C3	C2	C1	C0	
4	Data(01 ₁₆)		0	0	0	REV	BLINK	B	G	R	C7	C6	C5	C4	C3	C2	C1	C0	
{	}																		
241	Data(EE ₁₆)		0	0		REV	BLINK	B	G	R	C7	C6	C5	C4	C3	C2	C1	C0	
242	Data(EF ₁₆)		0	0	0	REV	BLINK	B	G	R	C7	C6	C5	C4	C3	C2	C1	C0	
243	Data(F0 ₁₆)	Register address F0 ₁₆ to F7 ₁₆ setting	0	0	0	0	0	1	0	0	1	0	0	0	PTD ₁	PTD ₀	PTC ₁	PTC ₀	
244	Data(F1 ₁₆)		0	0	0	1	1	1	1	1	HP ₇	HP ₆	HP ₅	HP ₄	HP ₃	HP ₂	HP ₁	HP ₀	
245	Data(F2 ₁₆)		0	0	0	1	1	1	1	1	VP ₇	VP ₆	VP ₅	VP ₄	VP ₃	VP ₂	VP ₁	VP ₀	
246	Data(F3 ₁₆)		0	0	0	0	0	0	0	0	VSZ ₂₁	VSZ ₂₀	VSZ ₁₁	VSZ ₁₀	HSZ ₂₁	HSZ ₂₀	HSZ ₁₁	HSZ ₁₀	
247	Data(F4 ₁₆)		0	0	0	0	0	SPACE	DSP ₉	DSP ₈	DSP ₇	DSP ₆	DSP ₅	DSP ₄	DSP ₃	DSP ₂	DSP ₁	DSP ₀	
248	Data(F5 ₁₆)		0	0	0	0	0	0	0	0	EQP	PALH	MPAL	INT/NON	N/P	BLINK ₂	BLINK ₁	BLINK ₀	
249	Data(F6 ₁₆)		0	0	1	TEST ₂	TEST ₁	TEST ₀	LBLACK	LIN _{24/32}	BLKHF	BB	BG	BR	LEVEL ₀	PHASE ₂	PHASE ₁	PHASE ₀	
250	Data(F7 ₁₆)		0	0	0	0	RGBON	0	CL _{17/18}	CBLINK	CURS ₇	CURS ₆	CURS ₅	CURS ₄	CURS ₃	CURS ₂	CURS ₁	CURS ₀	
251	Data(F8 ₁₆)		Display ON	0	0	LEVEL ₁	1	1	1	1	1	RAM ERS	DSPON	STOP ₁	STOP IN	SCOR	EX	BLK ₁	BLK ₀

Fig. 10 Example of data setting by the serial input function (M35055-XXXXFP)

SERIAL DATA INPUT TIMING

- (1) The address consists of 16 bits.
- (2) The data consists of 16 bits.
- (3) The 16 bits in the SCK after the \overline{CS} signal has fallen are the address, and for succeeding input data, the address is incremented every 16 bits.

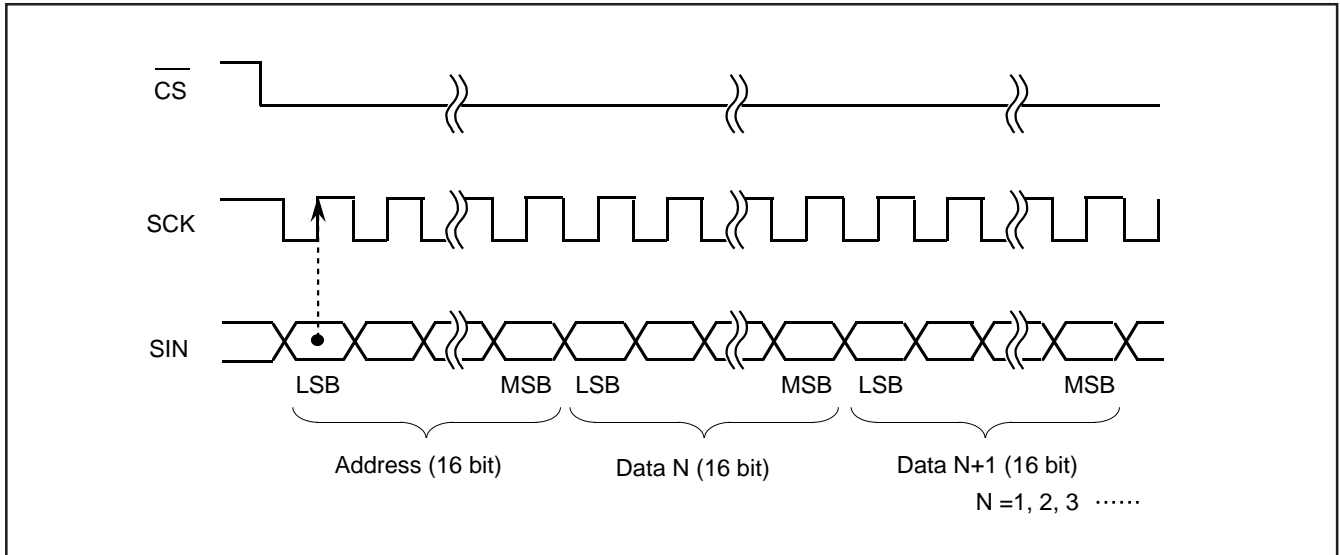

Fig. 11 Serial input timing

CHARACTER FONT

Images are composed on a 12 X 18 dot matrix, and characters can be linked vertically and horizontally with other characters to allow the display the continuous symbols.

Character code "FF16" is so fixed as to be blank and to have no background, thus cannot assign a character font to this code.

(1) Border display (set by register BLK0, 1 (address F816))

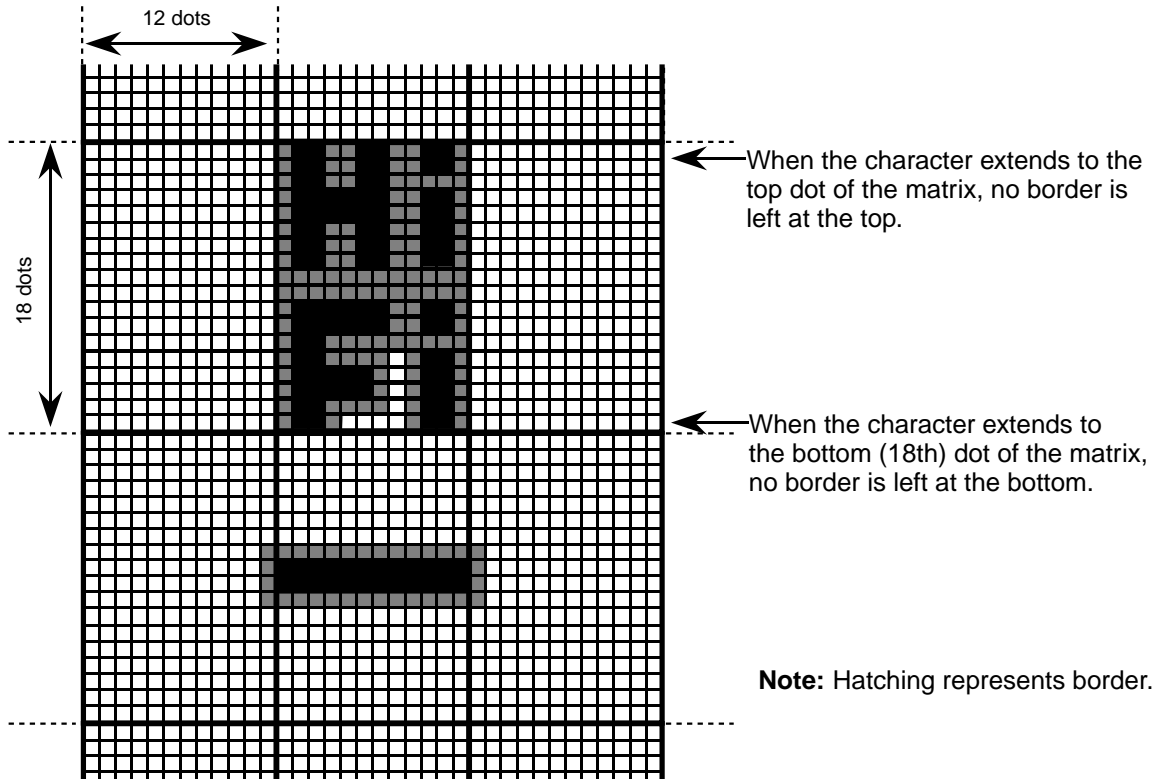

(2) Cursor display (Border display)

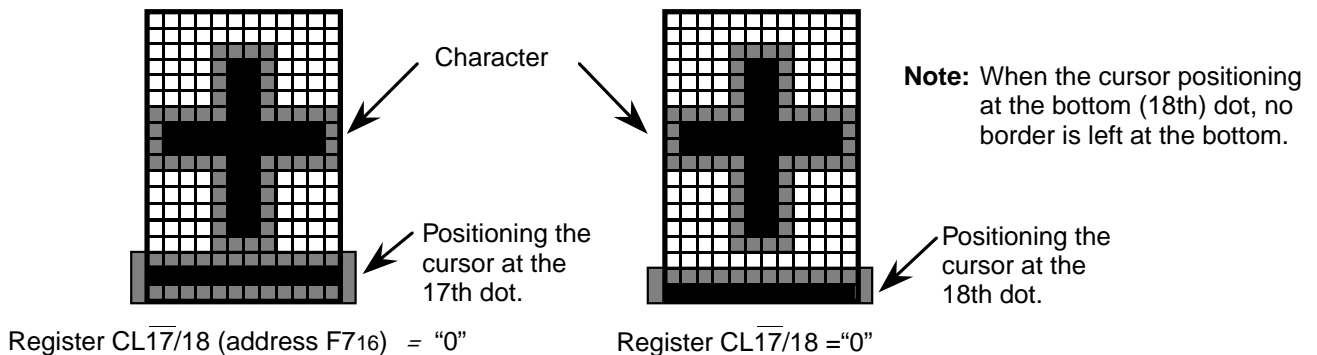

Fig. 12 Character font and border

M35054-XXXFP/M35055-XXXFP

SCREEN CHARACTER and PATTERN DISPLAY CONTROLLERS

M35054-XXXFP/M35055-XXXFP PERIPHERAL CIRCUIT

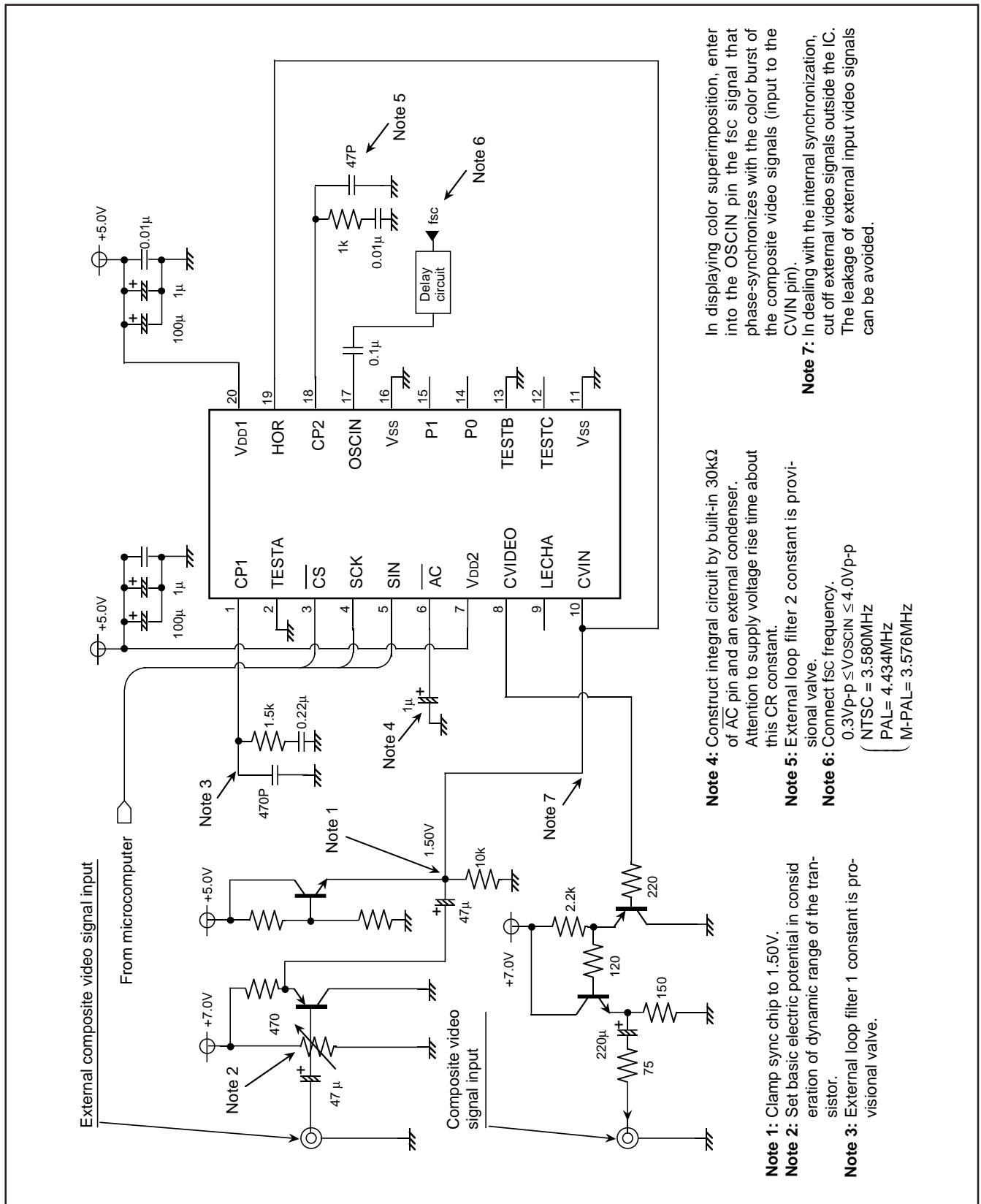

Fig. 13 M35054-XXXFP/M35055-XXXFP example of peripheral circuit

In displaying color superimposition, enter into the OSCIN pin the fsc signal that phase-synchronizes with the color burst of the composite video signals (input to the CVIN pin).

Note 7: In dealing with the internal synchronization, cut off external video signals outside the IC. The leakage of external input video signals can be avoided.

Note 4: Construct integral circuit by built-in 30kΩ of AC pin and an external condenser. Attention to supply voltage rise time about this CR constant.

Note 5: External loop filter 2 constant is provisional valve.

Note 6: Connect fsc frequency.
 $0.3Vp-p \leq V_{OSCIN} \leq 4.0Vp-p$
 NTSC = 3.580MHz
 PAL = 4.434MHz
 (M-PAL = 3.576MHz

Note 1: Clamp sync chip to 1.50V.

Note 2: Set basic electric potential in consideration of dynamic range of the transistor.

Note 3: External loop filter 1 constant is provisional valve.

(2) Before setting registers at the starting of system, be sure to reset the M35052-XXXSP/FP by applying "L" level to the $\bar{A}C$ pin.

(3) Power supply noise

When power supply noise is generated, the internal oscillator circuit does not stabilize, whereby causing horizontal jitters across the picture display. Therefore, connect a bypass capacitor between the power supply and GND.

(4) Synchronous correction action

When switching channel or in the special playback mode (quick playback, rewinding, and so on) of VTR, effect of synchronous correction becomes strong, and distortion of a character is apt to occur because the continuity of video signal is suddenly switched. When the continuity of video signal is out of order, erasure of displayed characters is recommended in a extreme short time to raise the quality of displayed characters.

(5) Notes on fsc signal input

This IC amplifies the subcarrier frequency (fsc) signal (NTSC, M-PAL system: 3.58MHz, PAL system: 4.43MHz) input to the OSCIN pin (17-pin) and generates the composite video signal internally. The amplified fsc signal can be destabilized in the following cases.

- a) When the fsc signal is outside of recommended operating conditions.
- b) When the waveform of the fsc signal is distorted.
- c) When DC level in the fsc waveform fluctuates.

When the amplified signal is unstable, the composite video signal generated inside the IC is also unstable in terms of synchronization with the subcarrier and phase.

Consequently, this results in color flicker and lost synchronization when the composite video signal is generated. Make note of the fact that this may prevent a stable blue background from being formed.

(6) Forbidding to stop entering the fsc signal

This IC doesn't properly work if the fsc signal is not entered into the OSCIN pin (pin 17), so don't stop the fsc signal so as to work the IC. To stop the IC, turn the display off (set 0 in the register DSPON (address F816).)

(7) Forbidding to set data during the period in which the internal oscillation circuit stabilizes

- a) To start entering the fsc signal when its input is stopped.
- b) To start oscillating the oscillation circuit for display when its oscillation is stopped. (to assign "1" to the register STOP1 (address F816) when it is assigned "0", or the like.)
- c) To turn on the internal bias when it is turned off. (to assign "1" to the register LEVEL1 (address F816) when it is assigned "0".)

There can be instances in which data are not properly set in the registers until the internal oscillation circuit stabilizes, so follow the steps in sequence as given below.

- 1) Set "0" in the register DSPON (address F816). (the display is turned off)
- 2) Effect the settings a), b), and c) given above.

3) Wait 20 ms (the period necessary for the internal oscillation circuit to stabilize) before entering data.

4) Set necessary data in other registers, and make the display RAM ready.

TIMING REQUIREMENTS ($T_a = -20^{\circ}\text{C}$ to 70°C , $V_{DD} = 5 \pm 0.25\text{V}$, unless otherwise noted)

Symbol	Parameter	Limits			Unit
		Min.	Typ.	Max.	
$t_w(\text{SCK})$	SCK width	400	—	—	ns
$t_{su}(\overline{\text{CS}})$	$\overline{\text{CS}}$ setup time	200	—	—	ns
$t_h(\text{CS})$	$\overline{\text{CS}}$ hold time	2	—	—	μs
$t_{su}(\text{SIN})$	SIN setup time	200	—	—	ns
$t_h(\text{SIN})$	SIN hold time	200	—	—	ns
t_{word}	1 word writing time	12.8	—	—	μs

Note. When oscillation stop at register STOR1 (address F816), 1V (field term) or more of $t_{su}(\overline{\text{CS}})$ and $t_h(\text{CS})$ are needed.

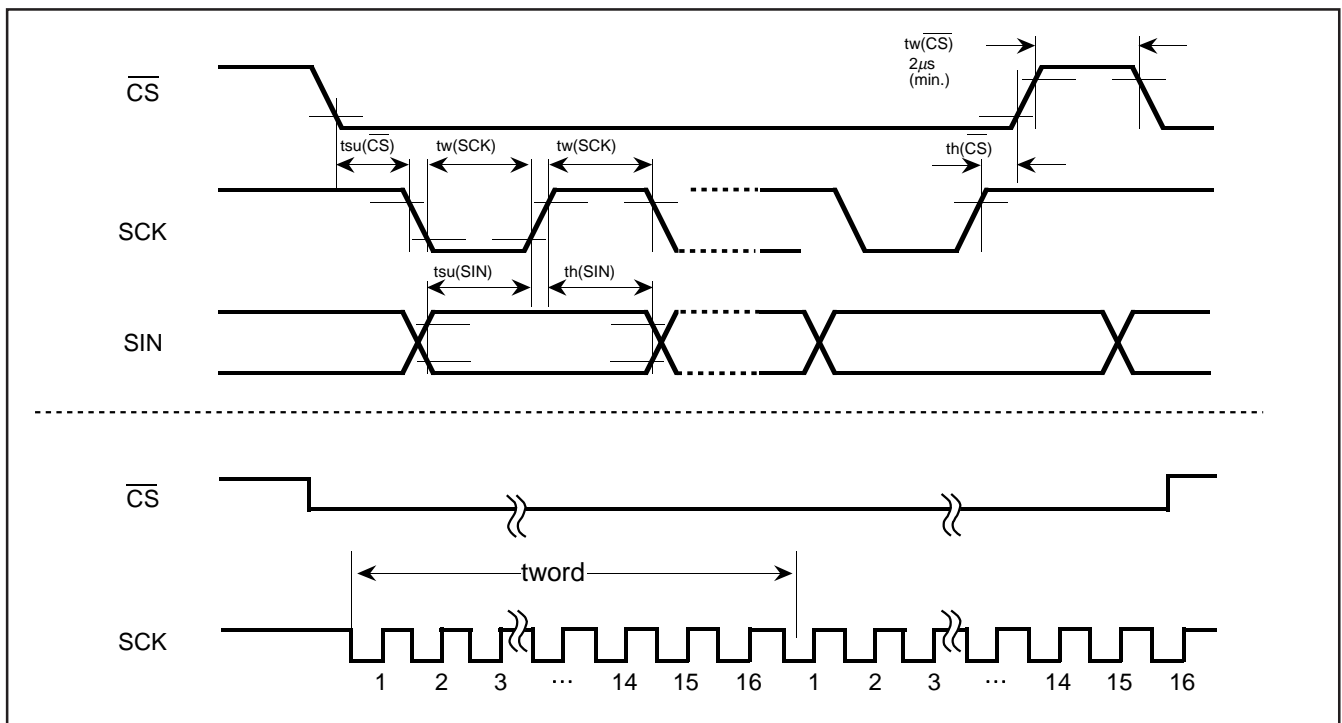

Fig. 16 Serial input timing requirements

MITSUBISHI MICROCOMPUTERS
M35054-XXXFP/M35055-XXXFP

SCREEN CHARACTER and PATTERN DISPLAY CONTROLLERS

ABSOLUTE MAXIMUM RATINGS ($V_{DD} = 5V$, $T_a = -20$ to $70^{\circ}C$, unless otherwise noted)

Symbol	Parameter	Conditions	Ratings	Unit
VDD	Supply voltage	With respect to VSS	-0.3~6.0	V
VI	Input voltage		$V_{SS}-0.3 \leq V_I \leq V_{DD}+0.3$	V
VO	Output voltage		$V_{SS} \leq V_O \leq V_{DD}$	V
Pd	Power dissipation	$T_a=25^{\circ}C$	300	mW
Topr	Operating temperature		-20~70	$^{\circ}C$
Tstg	Storage temperature		-40~125	$^{\circ}C$

RECOMMENDED OPERATING CONDITIONS ($V_{DD} = 5V$, $T_a = -20$ to $70^{\circ}C$, unless otherwise noted)

Symbol	Parameter	Limits			Unit	
		Min.	Typ.	Max.		
VDD	Supply voltage	4.75	5.00	5.25	V	
VIH	"H" level input voltage \overline{AC} , CS, SIN, SCK, TESTA, TESTB	$0.8 \times V_{DD}$	VDD	VDD	V	
VIL	"L" level input voltage \overline{AC} , \overline{CS} , SIN, SCK, TESTA, TESTB	0	0	$0.2 \times V_{DD}$	V	
VCVIN	CVIN, HOR	-	2.0VP-P	-	V	
VOSCIN	Input voltage OSCIN (Note)	0.3VP-P	-	4.0VP-P	V	
fOSCIN	Synchronous signal oscillation frequency (Duty 40~60%)	-	3.580 4.434 3.576	-	MHz	
fOSC1	Display oscillation frequency	24 charactersX10 lines	-	480Xfh	-	MHz
fOSC2		32 charactersX7 lines	-	640Xfh	-	MHz

- Notes 1.** Noise component is within 30mV.
2. fh: Horizontal synchronous frequency (MHz).

ELECTRICAL CHARACTERISTICS ($V_{DD} = 5V$, $T_a = 25^{\circ}C$, unless otherwise noted)

Symbol	Parameter	Test conditions	Limits			Unit
			Min.	Typ.	Max.	
VDD	Supply voltage	$T_a=-20 \sim 70^{\circ}C$	4.75	5.00	5.25	V
IDD	Supply current	$V_{DD}=5.00V$	-	30	50	mA
VOH	"H" level output voltage P0, P1	$V_{DD}=4.75V$, $I_{OH}=-0.4mA$	3.75	-	-	V
VOL	"L" level output voltage P0, P1	$V_{DD}=4.75V$, $I_{OL}=0.4mA$	-	-	0.4	V
RI	Pull-up resistance \overline{AC} , CS, SCK, SIN, TESTB	$V_{DD}=5.00V$	10	30	100	k Ω

VIDEO SIGNAL INPUT CONDITIONS ($V_{DD} = 5V$, $T_a = -20$ to $70^{\circ}C$, unless otherwise noted)

Symbol	Parameter	Test conditions	Limits			Unit
			Min.	Typ.	Max.	
VIN-SC	Composite video signal input clamp voltage	Sync-chip voltage	-	1.5	-	V

Note for Supplying Power

(1) Timing of power supplying to \overline{AC} pin

The internal circuit of M35054-XXXFP/ M35055-XXXFP is reset when the level of the auto clear input pin \overline{AC} is "L". This pin is hysteresis input with the pull-up resistor. The timing about power supplying of \overline{AC} pin is shown in Figure 16. t_w is the interval after the supply voltage becomes $0.8 \times V_{DD}$ or more and before the supply voltage to the \overline{AC} pin ($V_{\overline{AC}}$) becomes $0.2 \times V_{DD}$ or more. After supplying the power (V_{DD} and V_{SS}) to M35054-XXXFP/ M35055-XXXFP, the t_w time must be reserved for 1ms or more.

Before starting input from the microcomputer, the waiting time (t_s) must be reserved for 500ms after the supply voltage to the \overline{AC} pin becomes $0.8 \times V_{DD}$ or more.

(2) Timing of power supplying to V_{DD1} pin and V_{DD2} pin

The power need to supply to V_{DD1} and V_{DD2} at a time, though it is separated perfectly between the V_{DD1} as the digital line and the V_{DD2} as the analog line.

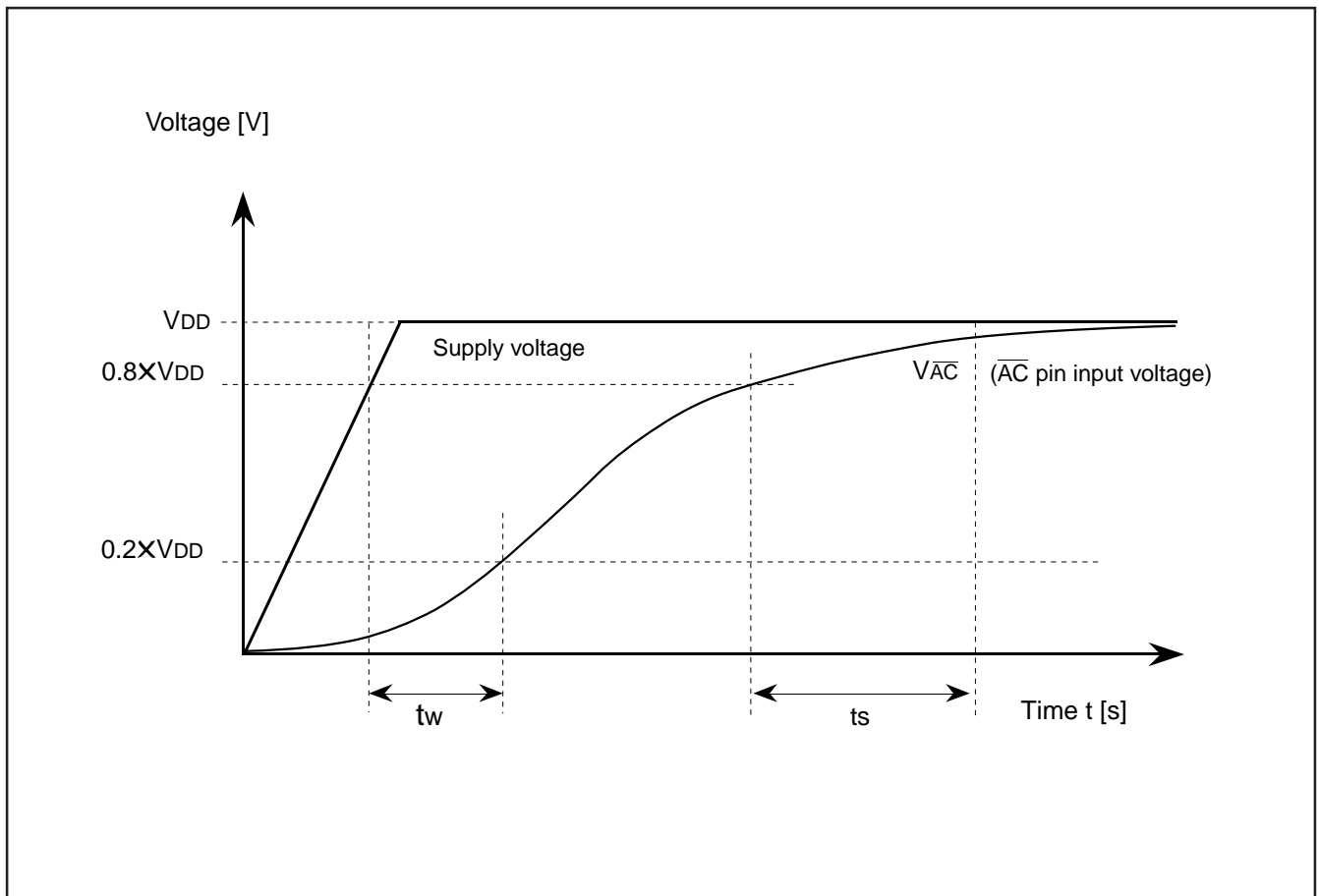

Fig. 17 Timing of power supplying to \overline{AC} pin

PRECAUTION FOR USE

Notes on noise and latch-up

Connect a capacitor (approx. $0.1 \mu F$) between pins V_{DD} and V_{SS} at the shortest distance using relatively thick wire to prevent noise and latch up.

ROM ORDERING METHOD

Please submit the information described below when ordering Mask ROM.

- (1) ROM Order Confirmation Form 1
- (2) Data to be written into mask ROM EPROM
(three sets containing the identical data)
- (3) Mark Specification Form 1
- (4) Program for character font generating + floppy disk in which character data is input

STANDARD ROM TYPE : M35054-001FP

M35054-001FP is a standard ROM type of M35054-XXXFP
character patterns are fixed to the contents of Figure 18 to 19.

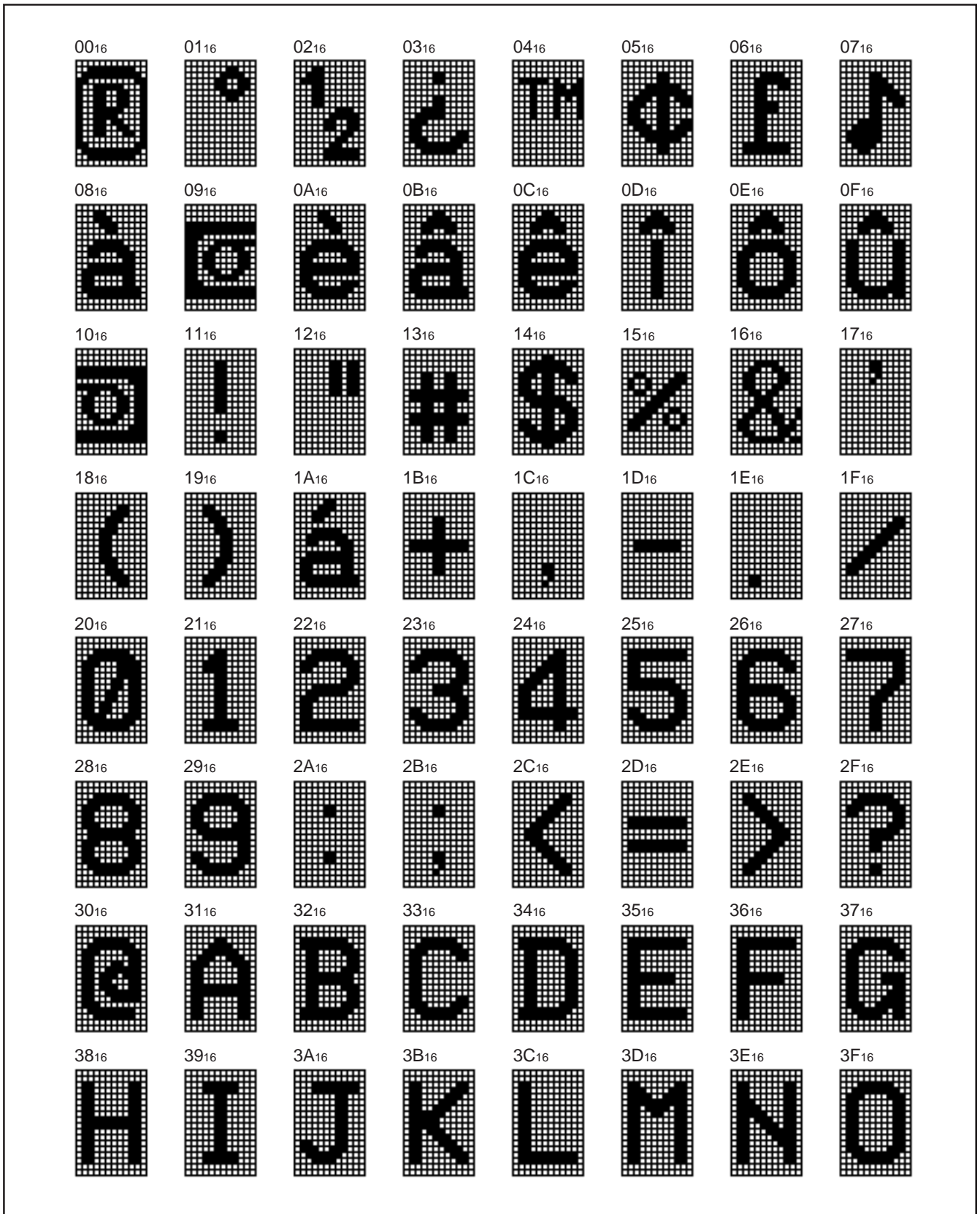

Fig. 18 M35054-001FP character pattern (1)

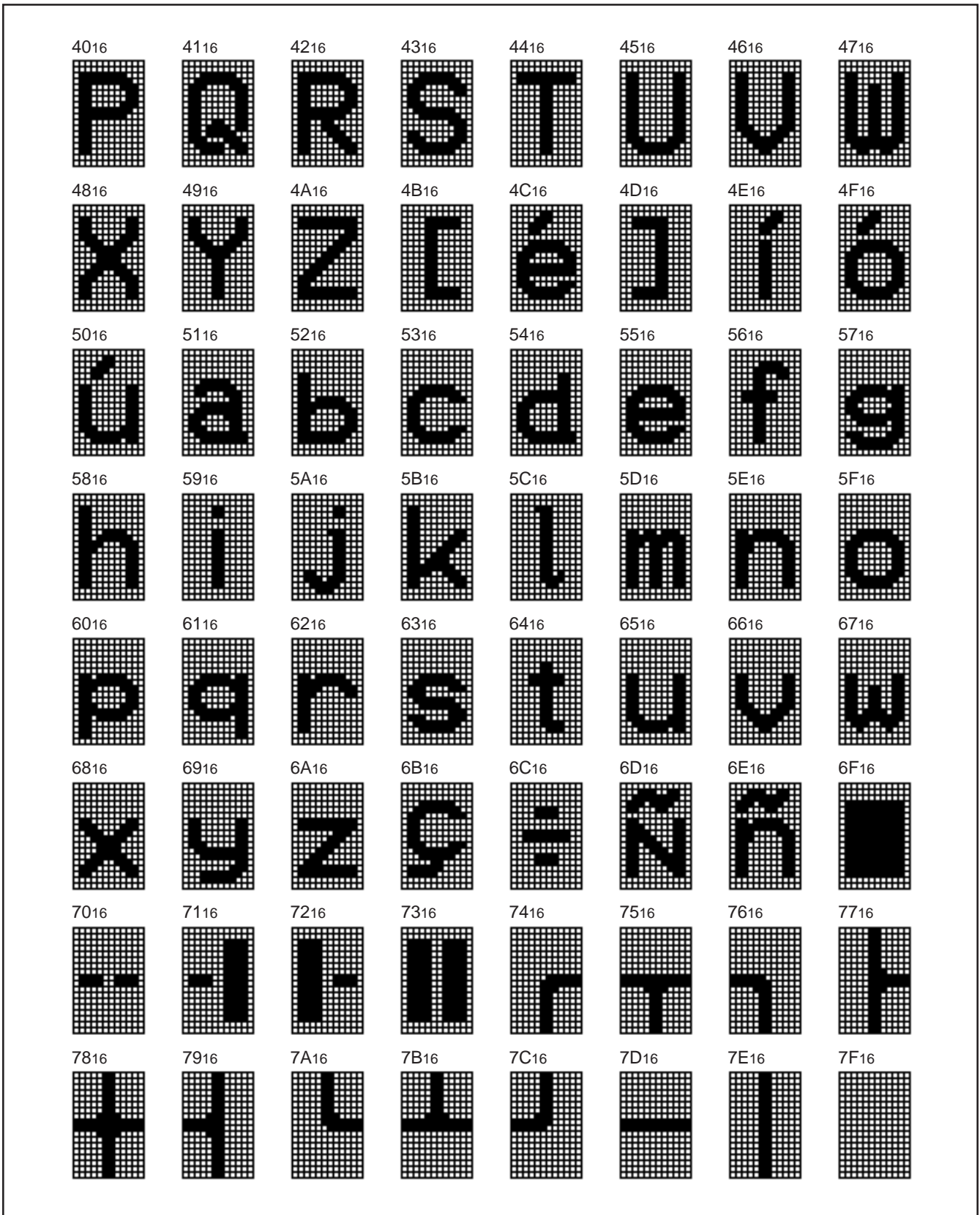

Fig. 19 M35054-001FP character pattern (2)

STANDARD ROM TYPE : M35055-001FP

M35055-001FP is a standard ROM type of M35055-XXXFP
Character patterns are fixed to the contents of Figure 20 to 23.

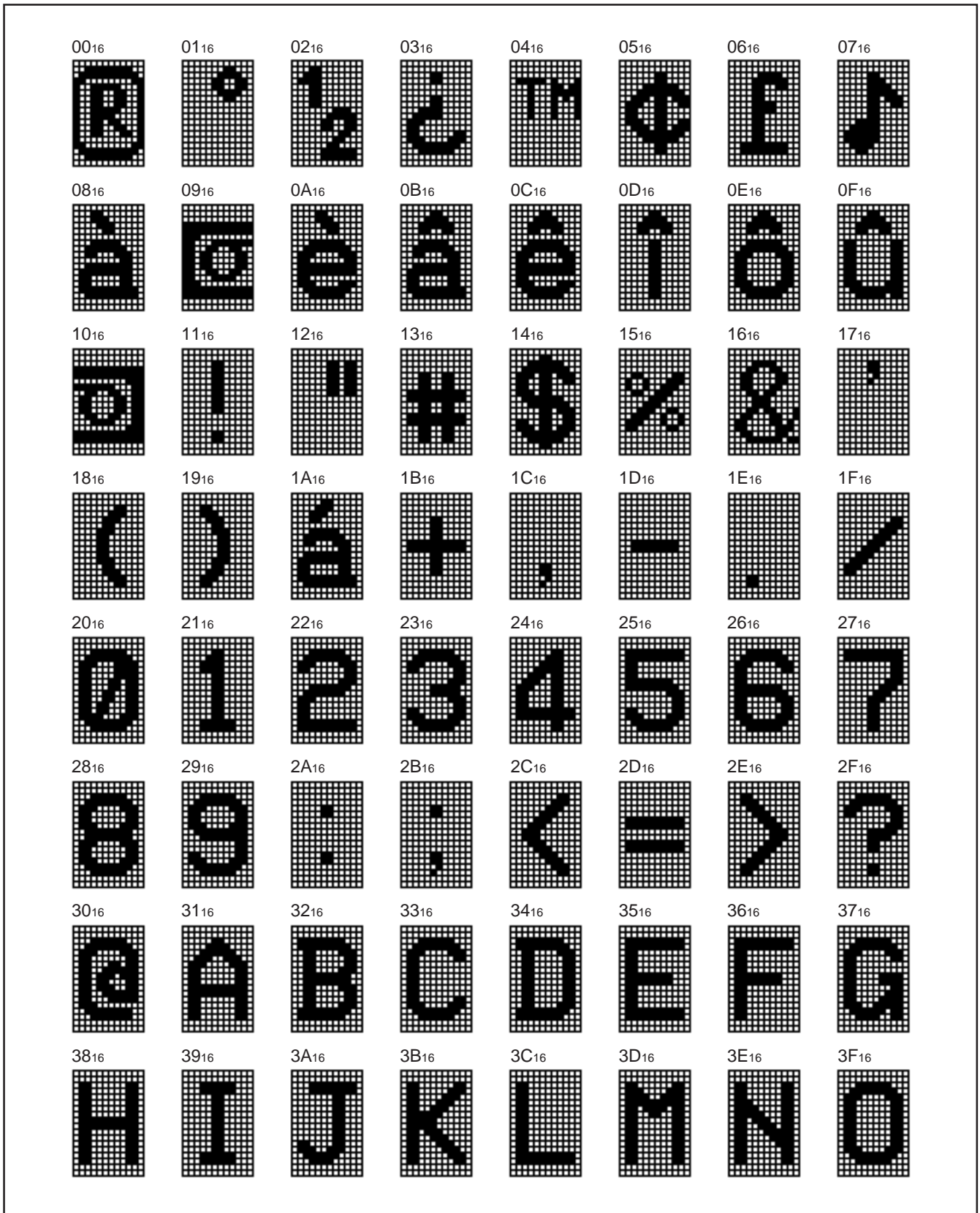

Fig. 20 M35055-001FP character pattern (1)



Fig. 21 M35055-001FP character pattern (2)



Fig. 22 M35055-001FP character pattern (3)

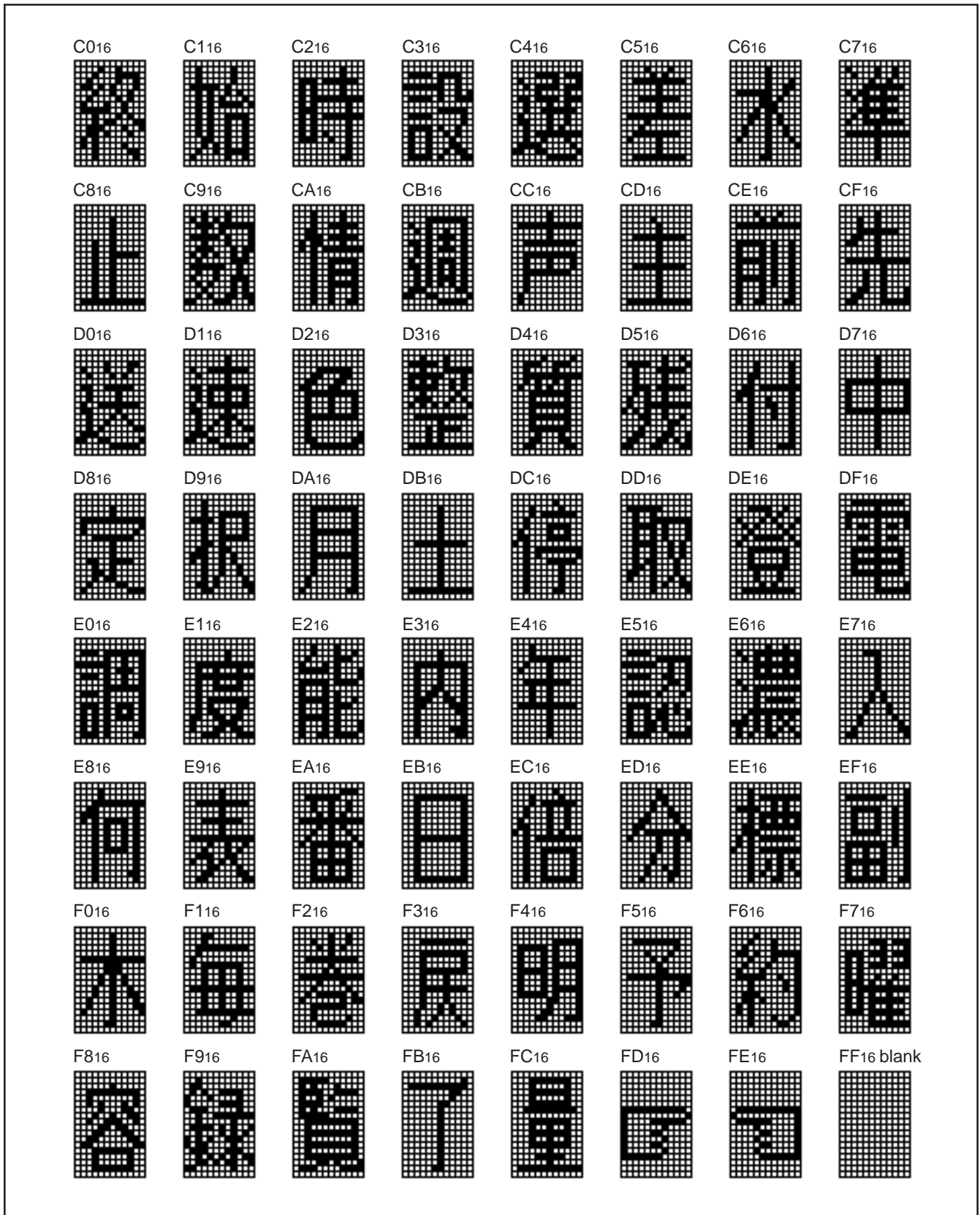

Fig. 23 M35055-001FP character pattern (4)

MASK ROM ORDER CONFIRMATION FORM
GZZ-SH00-59B <75A0>

Mask ROM number	
-----------------	--

MASK ROM ORDER CONFIRMATION FORM
SCREEN DISPLAY IC M35054-XXXFP
MITSUBISHI ELECTRIC

Receipt	Data :	
	Section head signature	Supervisor signature

Note : Please fill in all items marked *, .

* Customer	Company name	TEL ()	Issuance signature	Approval	Verification	Framing
	Data issued	Date :				

* Program version name	M054R	V
------------------------	-------	---

* Remarks

- Return the Character Font Preparation Program after use.
- Three EPROMs are required. (All the three EPROMs must be same types. Check in the appropriate box.)

27512

- (1) The font data prepared by the Character Font Preparation Program is saved as a binary type object file (addresses 0000h to 7FFFh). Three sets of these EPROMs are required.
- (2) Attach the erase protect seals on three EPROMs. Each seal bears the type name (M35054), and ROM No. (-...FP).

- Write the checksum code (hexadecimal notation) for entire EPROM areas.

Checksum

--	--	--	--

- Select the marking type (Check in the appropriate box).

Special Mark Fill in the Mark Specification Form (20P2Q-A for M35054-XXXFP) and attach to the Mask ROM Order Confirmation Form.

Standard Mark No writing is required.

- The package type

..... SSOP type (M35054-XXXFP)

* ● Comments

GZZ-SH00-59B <75A0>

Mask ROM number	
-----------------	--

※1. Test patterns

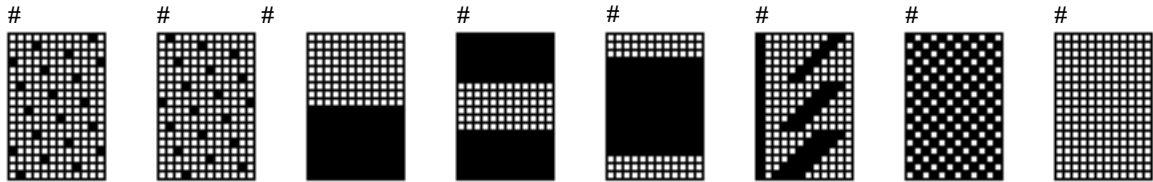

(The patterns with the mark “#” are test patterns)

※2. Character patterns (See the next page)

FF16 blank

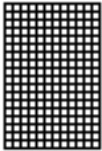

MITSUBISHI MICROCOMPUTERS
M35054-XXXFP/M35055-XXXFP

SCREEN CHARACTER and PATTERN DISPLAY CONTROLLERS

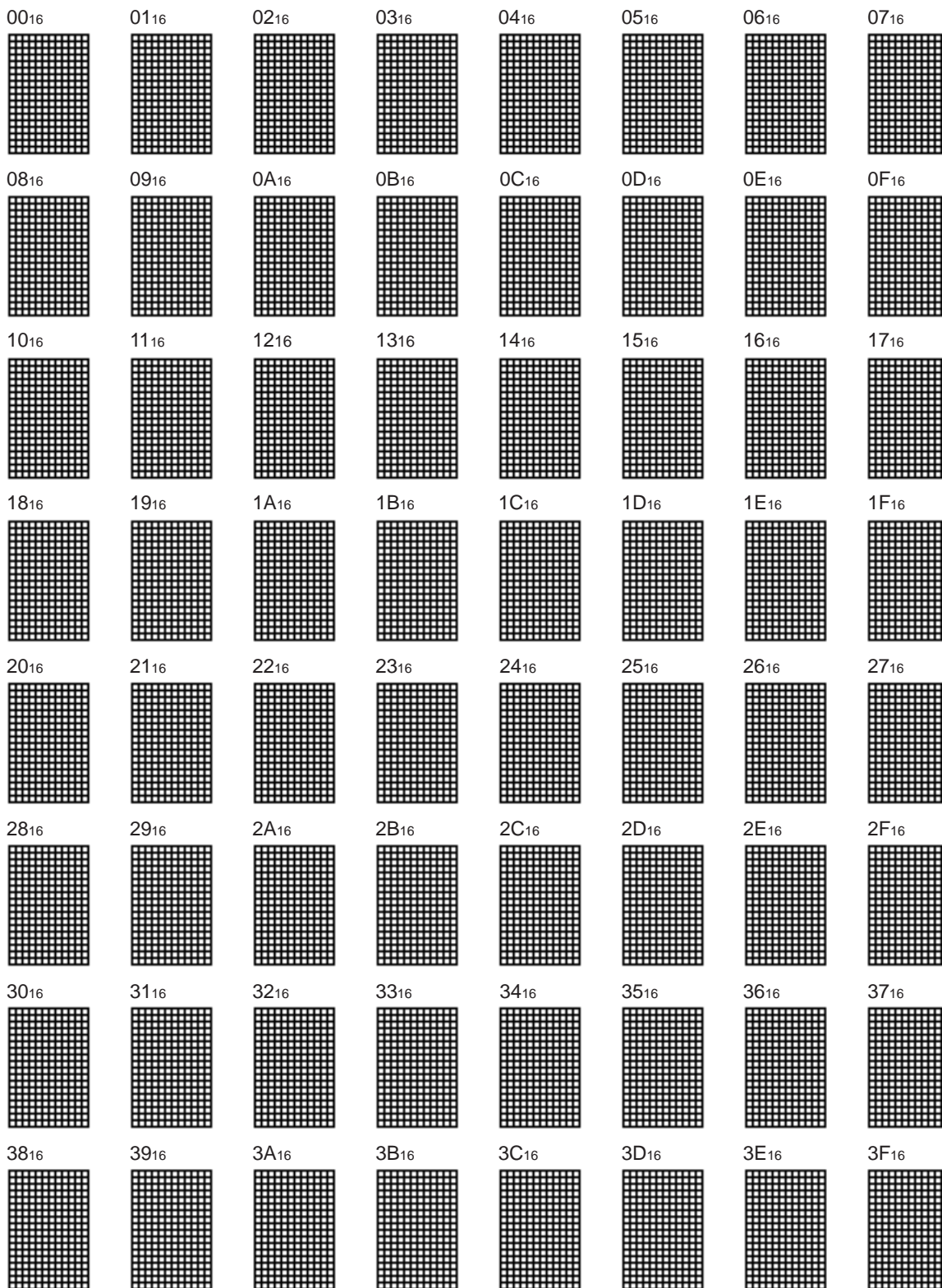

MITSUBISHI MICROCOMPUTERS
M35054-XXXFP/M35055-XXXFP

SCREEN CHARACTER and PATTERN DISPLAY CONTROLLERS

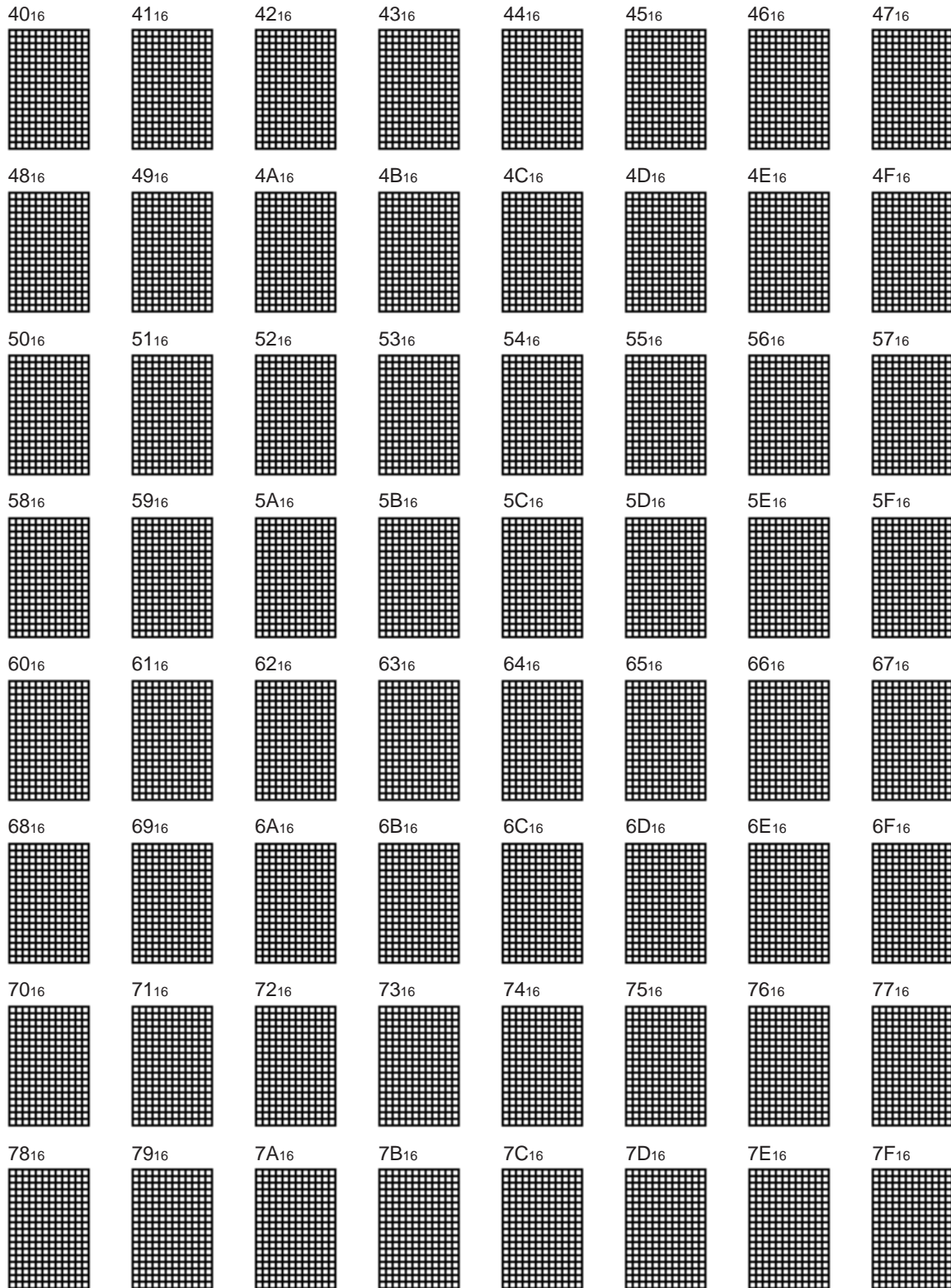

MASK ROM ORDER CONFIRMATION FORM
GZZ-SH00-60B <75A0>

Mask ROM number	
-----------------	--

MASK ROM ORDER CONFIRMATION FORM
SCREEN DISPLAY IC M35055-XXXFP
MITSUBISHI ELECTRIC

Receipt	Data :	
	Section head signature	Supervisor signature

Note : Please fill in all items marked *, .

*	Customer	Company name	TEL ()	Issuance signature	Approval	Verification	Framing
		Data issued	Date :				

*	Program version name	M055R	V
---	----------------------	-------	---

* Remarks

- Return the Character Font Preparation Program after use.
- Three EPROMs are required. (All the three EPROMs must be same types. Check in the appropriate box.)

27512

- (1) The font data prepared by the Character Font Preparation Program is saved as a binary type object file (addresses 0000h to 7FFFh). Three sets of these EPROMs are required.
- (2) Attach the erase protect seals on three EPROMs. Each seal bears the type name (M35055), and ROM No. (-...FP).

- Write the checksum code (hexadecimal notation) for entire EPROM areas.

Checksum

--	--	--	--

- Select the marking type (Check in the appropriate box).

Special Mark Fill in the Mark Specification Form (20P2Q-A for M35055-XXXFP) and attach to the Mask ROM Order Confirmation Form.

Standard Mark No writing is required.

- The package type

..... SSOP type (M35055-XXXFP)

* ● Comments

GZZ-SH00-60B <75A0>

Mask ROM number	
-----------------	--

※1. Test patterns

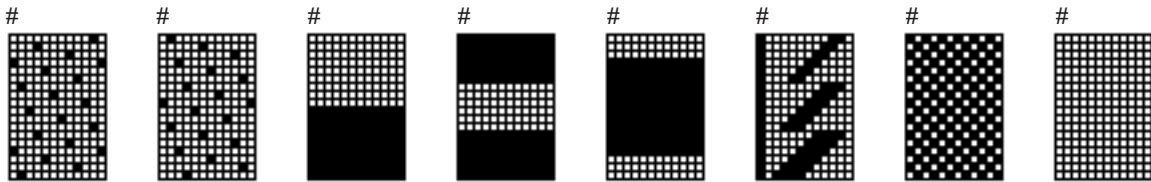

(The patterns with the mark “#” are test patterns)

※2. Character patterns (See the next page)

M35054-XXXFP/M35055-XXXFP

SCREEN CHARACTER and PATTERN DISPLAY CONTROLLERS

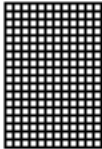
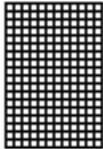
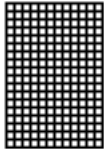
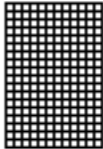
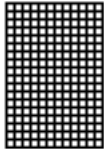
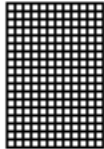
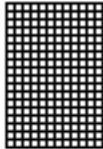
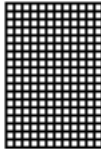
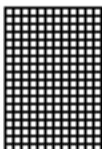
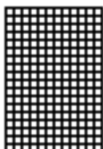
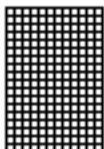
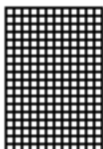
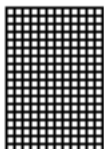
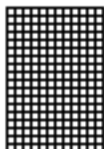
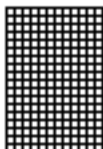
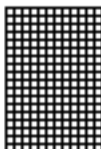
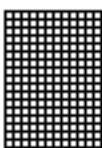
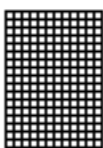
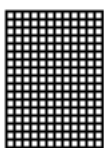
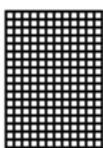
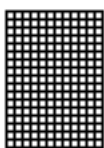
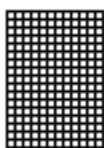
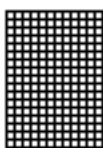
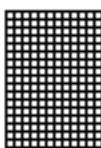
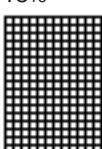
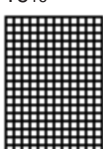
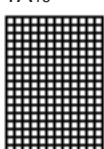
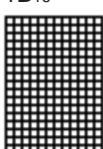
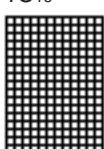
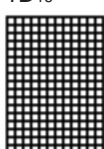
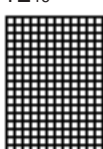
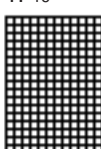
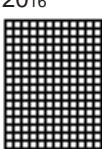
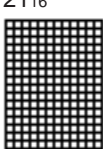
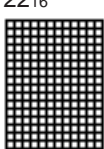
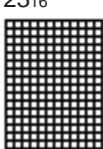
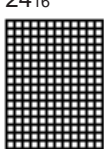
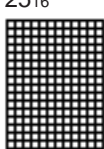
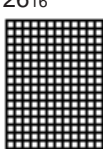
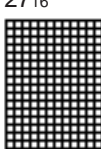
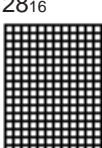
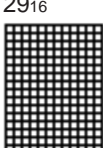
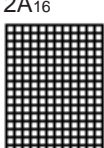
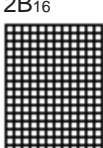
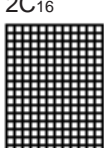
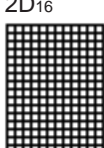
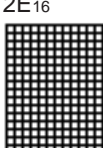
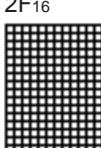
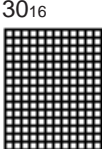
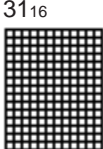
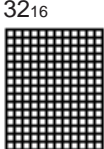
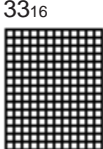
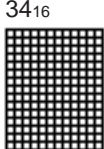
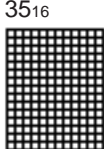
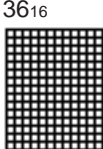
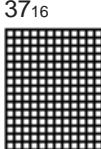
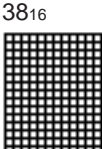
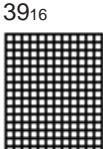
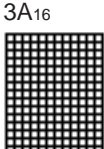
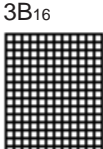
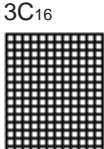
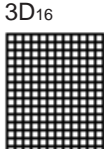
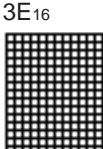
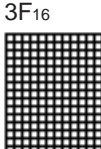
00 ₁₆ 	01 ₁₆ 	02 ₁₆ 	03 ₁₆ 	04 ₁₆ 	05 ₁₆ 	06 ₁₆ 	07 ₁₆ 
08 ₁₆ 	09 ₁₆ 	0A ₁₆ 	0B ₁₆ 	0C ₁₆ 	0D ₁₆ 	0E ₁₆ 	0F ₁₆ 
10 ₁₆ 	11 ₁₆ 	12 ₁₆ 	13 ₁₆ 	14 ₁₆ 	15 ₁₆ 	16 ₁₆ 	17 ₁₆ 
18 ₁₆ 	19 ₁₆ 	1A ₁₆ 	1B ₁₆ 	1C ₁₆ 	1D ₁₆ 	1E ₁₆ 	1F ₁₆ 
20 ₁₆ 	21 ₁₆ 	22 ₁₆ 	23 ₁₆ 	24 ₁₆ 	25 ₁₆ 	26 ₁₆ 	27 ₁₆ 
28 ₁₆ 	29 ₁₆ 	2A ₁₆ 	2B ₁₆ 	2C ₁₆ 	2D ₁₆ 	2E ₁₆ 	2F ₁₆ 
30 ₁₆ 	31 ₁₆ 	32 ₁₆ 	33 ₁₆ 	34 ₁₆ 	35 ₁₆ 	36 ₁₆ 	37 ₁₆ 
38 ₁₆ 	39 ₁₆ 	3A ₁₆ 	3B ₁₆ 	3C ₁₆ 	3D ₁₆ 	3E ₁₆ 	3F ₁₆ 

MITSUBISHI MICROCOMPUTERS
M35054-XXXFP/M35055-XXXFP

SCREEN CHARACTER and PATTERN DISPLAY CONTROLLERS

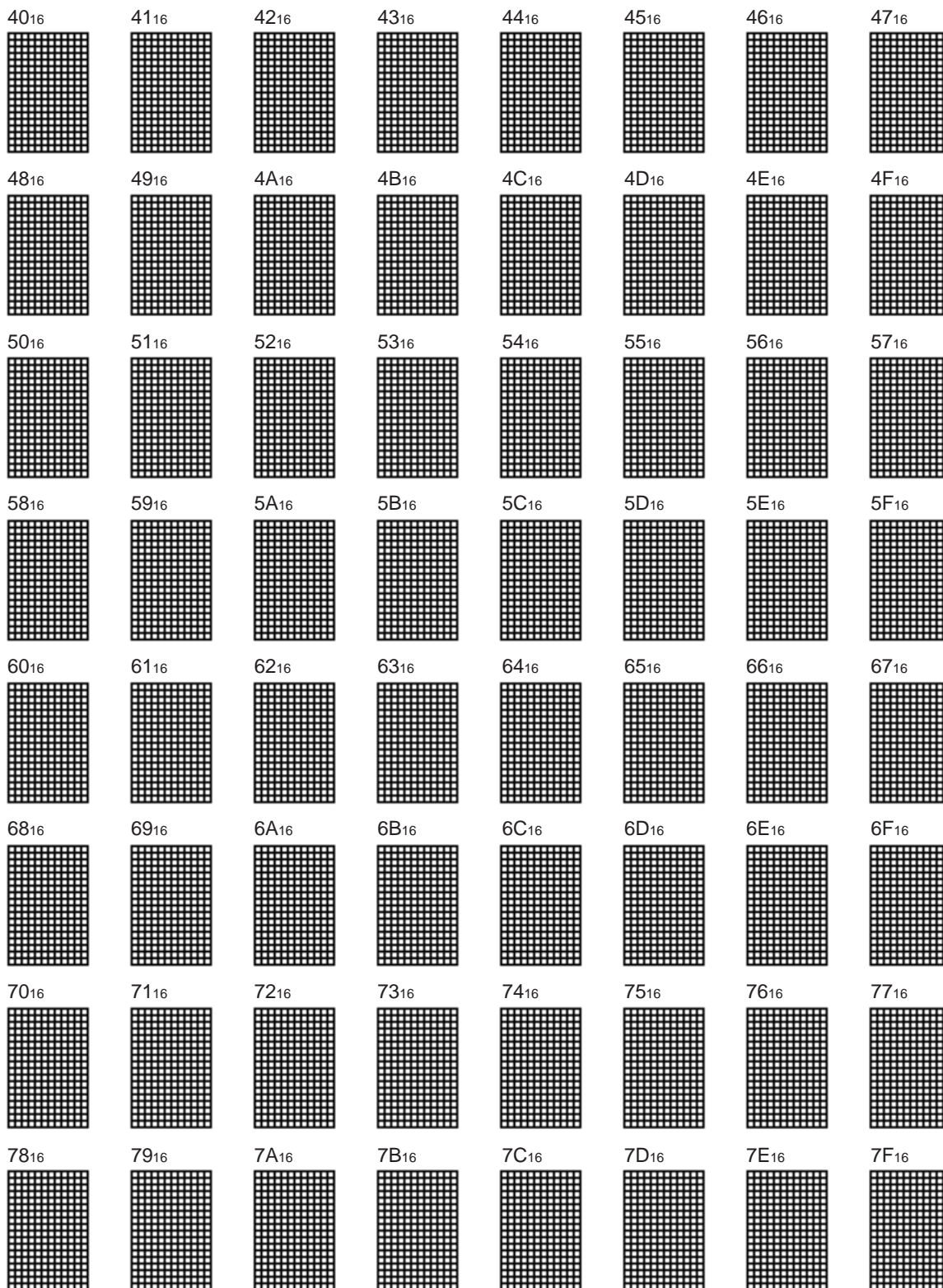

M35054-XXXFP/M35055-XXXFP

SCREEN CHARACTER and PATTERN DISPLAY CONTROLLERS

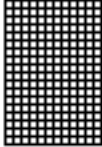
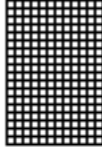
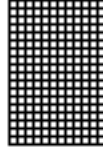
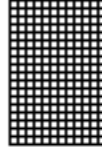
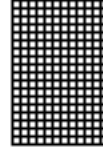
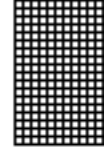
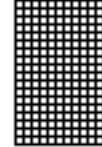
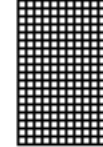
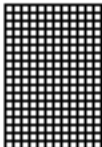
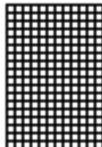
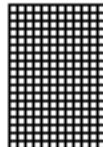
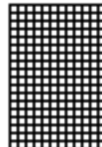
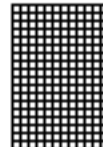
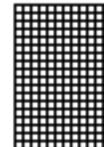
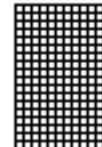
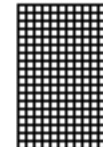
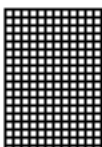
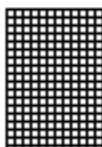
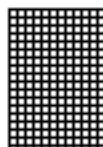
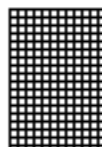
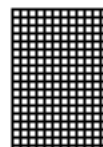
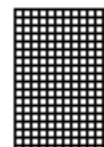
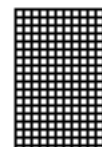
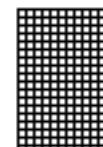
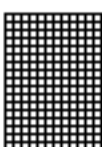
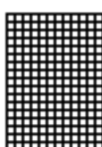
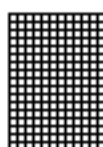
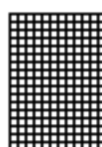
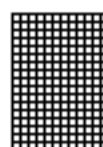
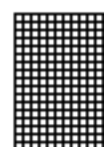
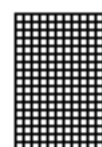
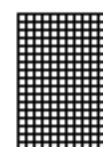
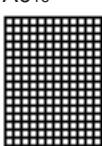
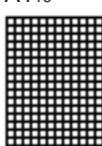
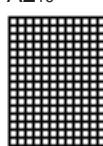
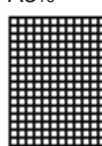
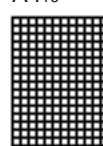
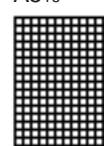
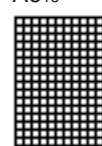
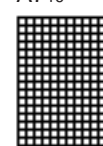
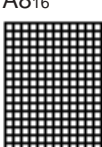
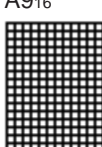
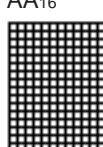
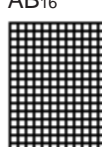
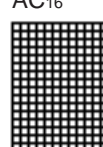
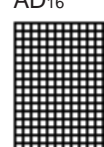
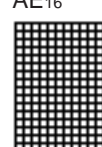
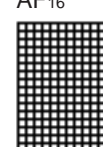
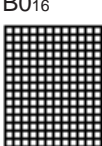
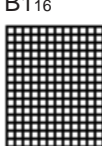
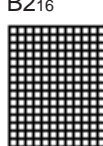
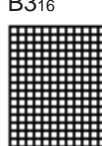
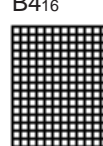
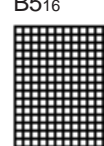
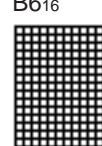
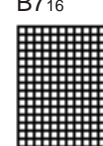
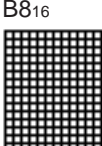
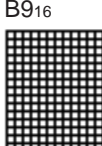
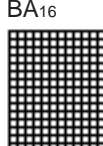
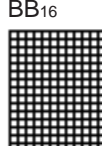
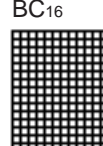
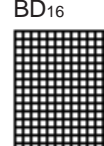
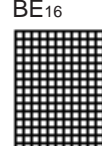
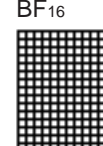
80 ₁₆ 	81 ₁₆ 	82 ₁₆ 	83 ₁₆ 	84 ₁₆ 	85 ₁₆ 	86 ₁₆ 	87 ₁₆ 
88 ₁₆ 	89 ₁₆ 	8A ₁₆ 	8B ₁₆ 	8C ₁₆ 	8D ₁₆ 	8E ₁₆ 	8F ₁₆ 
90 ₁₆ 	91 ₁₆ 	92 ₁₆ 	93 ₁₆ 	94 ₁₆ 	95 ₁₆ 	96 ₁₆ 	97 ₁₆ 
98 ₁₆ 	99 ₁₆ 	9A ₁₆ 	9B ₁₆ 	9C ₁₆ 	9D ₁₆ 	9E ₁₆ 	9F ₁₆ 
A0 ₁₆ 	A1 ₁₆ 	A2 ₁₆ 	A3 ₁₆ 	A4 ₁₆ 	A5 ₁₆ 	A6 ₁₆ 	A7 ₁₆ 
A8 ₁₆ 	A9 ₁₆ 	AA ₁₆ 	AB ₁₆ 	AC ₁₆ 	AD ₁₆ 	AE ₁₆ 	AF ₁₆ 
B0 ₁₆ 	B1 ₁₆ 	B2 ₁₆ 	B3 ₁₆ 	B4 ₁₆ 	B5 ₁₆ 	B6 ₁₆ 	B7 ₁₆ 
B8 ₁₆ 	B9 ₁₆ 	BA ₁₆ 	BB ₁₆ 	BC ₁₆ 	BD ₁₆ 	BE ₁₆ 	BF ₁₆ 

MITSUBISHI MICROCOMPUTERS
M35054-XXXFP/M35055-XXXFP

SCREEN CHARACTER and PATTERN DISPLAY CONTROLLERS

C016	C116	C216	C316	C416	C516	C616	C716
C816	C916	CA16	CB16	CC16	CD16	CE16	CF16
D016	D116	D216	D316	D416	D516	D616	D716
D816	D916	DA16	DB16	DC16	DD16	DE16	DF16
E016	E116	E216	E316	E416	E516	E616	E716
E816	E916	EA16	EB16	EC16	ED16	EE16	EF16
F016	F116	F216	F316	F416	F516	F616	F716
F816	F916	FA16	FB16	FC16	FD16	FE16	FF16 blank

20P2Q-A (20-PIN SSOP) MARK SPECIFICATION FORM

Mitsubishi IC catalog name

Please choose one of the marking types below (A, B, C), and enter the Mitsubishi IC catalog name and the special mark (if needed).

A. Standard Mitsubishi Mark

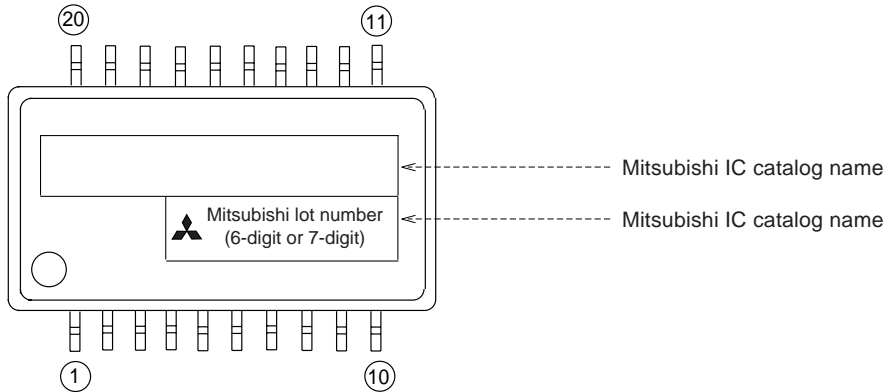

B. Customer's Parts Number + Mitsubishi IC Catalog Name

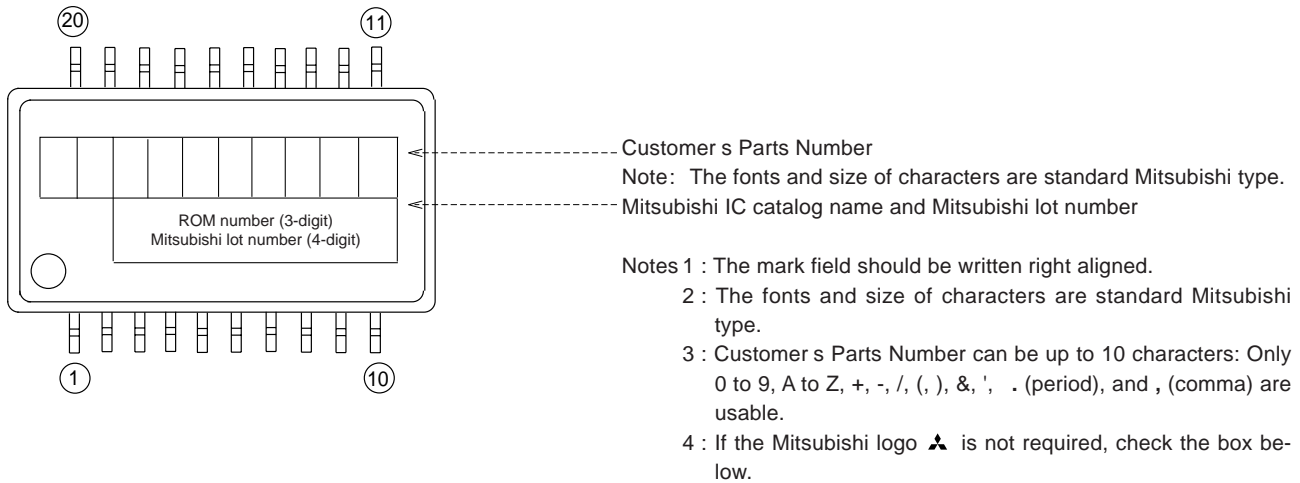

- Notes 1 : The mark field should be written right aligned.
 2 : The fonts and size of characters are standard Mitsubishi type.
 3 : Customer's Parts Number can be up to 10 characters: Only 0 to 9, A to Z, +, -, /, (,), &, ', . (period), and , (comma) are usable.
 4 : If the Mitsubishi logo is not required, check the box below.

Mitsubishi logo is not required

C. Special Mark Required

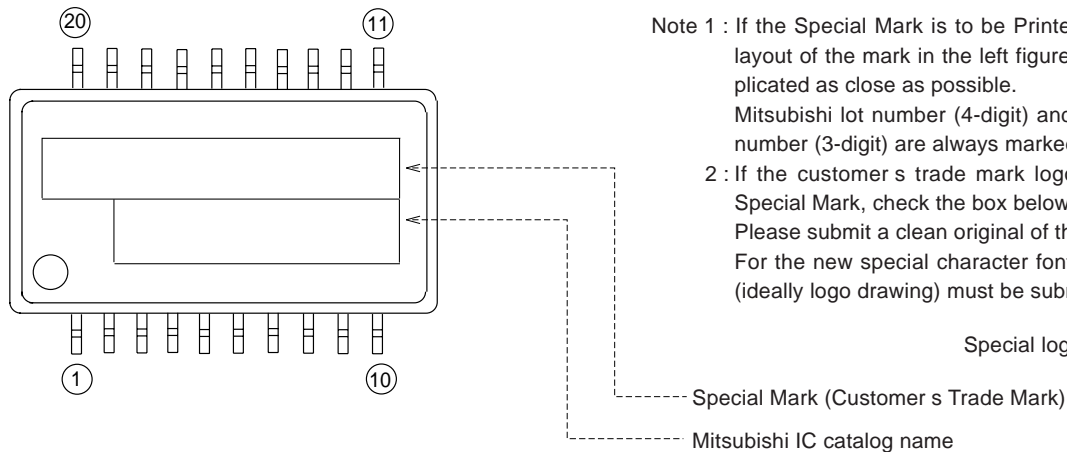

- Note 1 : If the Special Mark is to be Printed, indicate the desired layout of the mark in the left figure. The layout will be duplicated as close as possible.
 Mitsubishi lot number (4-digit) and Mask ROM number (3-digit) are always marked.
 2 : If the customer's trade mark logo must be used in the Special Mark, check the box below.
 Please submit a clean original of the logo.
 For the new special character fonts, a clean font original (ideally logo drawing) must be submitted.

Special logo required

M35054-XXXFP/M35055-XXXFP

SCREEN CHARACTER and PATTERN DISPLAY CONTROLLERS

PACKAGE OUTLINE

20P2Q-A

Plastic 20pin 300mil SSOP

EIAJ Package Code	JEDEC Code	Weight (g)	Lead Material
SSOP020-P-0300	-	0.2	Cu Alloy

Scale : 4/1

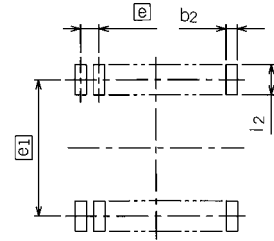
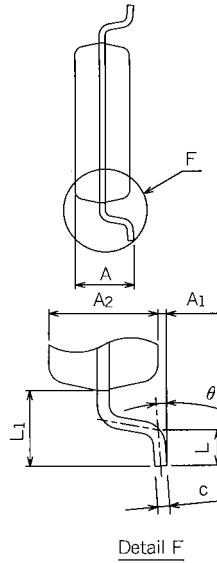
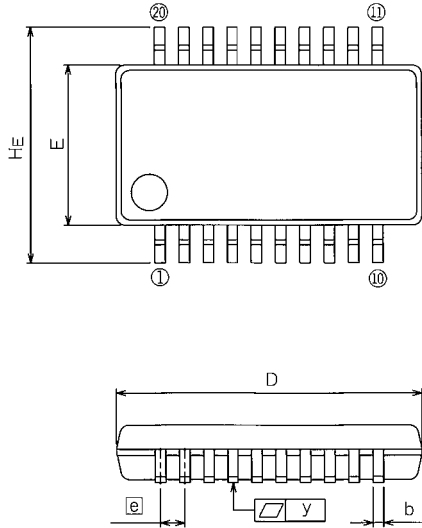

Recommended Mount Pad

Symbol	Dimension in Millimeters		
	Min	Nom	Max
A	-	-	2.1
A1	0	0.1	0.2
A2	-	1.8	-
b	0.3	0.35	0.45
c	0.18	0.2	0.25
D	10.0	10.1	10.2
E	5.2	5.3	5.4
e	-	0.8	-
HE	7.5	7.8	8.1
L	0.4	0.6	0.8
L1	-	1.25	-
y	-	-	0.1
theta	0°	-	8°
b2	-	0.5	-
e1	-	7.62	-
l2	1.27	-	-

MITSUBISHI MICROCOMPUTERS
M35054-XXXXP/M35055-XXXXP

SCREEN CHARACTER and PATTERN DISPLAY CONTROLLERS



Keep safety first in your circuit designs!

- Mitsubishi Electric Corporation puts the maximum effort into making semiconductor products better and more reliable, but there is always the possibility that trouble may occur with them. Trouble with semiconductors may lead to personal injury, fire or property damage. Remember to give due consideration to safety when making your circuit designs, with appropriate measures such as (i) placement of substitutive, auxiliary circuits, (ii) use of non-flammable material or (iii) prevention against any malfunction or mishap.

Notes regarding these materials

- These materials are intended as a reference to assist our customers in the selection of the Mitsubishi semiconductor product best suited to the customer's application; they do not convey any license under any intellectual property rights, or any other rights, belonging to Mitsubishi Electric Corporation or a third party.
- Mitsubishi Electric Corporation assumes no responsibility for any damage, or infringement of any third-party's rights, originating in the use of any product data, diagrams, charts, programs, algorithms, or circuit application examples contained in these materials.
- All information contained in these materials, including product data, diagrams, charts, programs and algorithms represents information on products at the time of publication of these materials, and are subject to change by Mitsubishi Electric Corporation without notice due to product improvements or other reasons. It is therefore recommended that customers contact Mitsubishi Electric Corporation or an authorized Mitsubishi Semiconductor product distributor for the latest product information before purchasing a product listed herein.
- The information described here may contain technical inaccuracies or typographical errors. Mitsubishi Electric Corporation assumes no responsibility for any damage, liability, or other loss rising from these inaccuracies or errors. Please also pay attention to information published by Mitsubishi Electric Corporation by various means, including the Mitsubishi Semiconductor home page (<http://www.mitsubishichips.com>).
- When using any or all of the information contained in these materials, including product data, diagrams, charts, programs, and algorithms, please be sure to evaluate all information as a total system before making a final decision on the applicability of the information and products. Mitsubishi Electric Corporation assumes no responsibility for any damage, liability or other loss resulting from the information contained herein.
- Mitsubishi Electric Corporation semiconductors are not designed or manufactured for use in a device or system that is used under circumstances in which human life is potentially at stake. Please contact Mitsubishi Electric Corporation or an authorized Mitsubishi Semiconductor product distributor when considering the use of a product contained herein for any specific purposes, such as apparatus or systems for transportation, vehicular, medical, aerospace, nuclear, or undersea repeater use.
- The prior written approval of Mitsubishi Electric Corporation is necessary to reprint or reproduce in whole or in part these materials.
- If these products or technologies are subject to the Japanese export control restrictions, they must be exported under a license from the Japanese government and cannot be imported into a country other than the approved destination.
Any diversion or reexport contrary to the export control laws and regulations of Japan and/or the country of destination is prohibited.
- Please contact Mitsubishi Electric Corporation or an authorized Mitsubishi Semiconductor product distributor for further details on these materials or the products contained therein.

REVISION DESCRIPTION LIST

M35054-XXXFP/M35055-XXXFP DATA SHEET

Rev. No.	Revision Description	Rev. date
1.0	First Edition	980402
1.1	P48 20P2Q-A (20-PIN SSOP) MARK SPECIFICATION FORM B: Note 4 added	000707