

PRELIMINARY
 Notice: This is not a final specification.
 Some parametric limits are subject to change.

MITSUBISHI MICROCOMPUTERS

M37753M6C-XXXFP, M37753M6C-XXXHP

SINGLE-CHIP 16-BIT CMOS MICROCOMPUTER

DESCRIPTION

The M37753M6C-XXXFP and M37753M6C-XXXHP are single-chip microcomputers designed with high-performance CMOS silicon gate technology. This is housed in a 80-pin plastic molded QFP.

This microcomputer has a CPU and a bus interface unit. The CPU is a 16-bit parallel processor that can also be switched to perform 8-bit parallel processing, and the bus interface unit enhances the memory access efficiency to execute instructions fast.

In addition to the 7700 Family basic instructions, the M37753M6C-XXXFP has 6 special instructions which contain instructions for signed multiplication/division; these added instructions improve the servo arithmetic performance to control hard disk drives and so on. This microcomputer also include the ROM, RAM, multiple-function timers, motor control function, serial I/O, A-D converter, D-A converter, and so on.

DISTINCTIVE FEATURES

- Number of basic machine instructions 109
 (103 basic instructions of 7700 Family + 6 special instructions)
- Memory size ROM 48 Kbytes
 RAM 2048 bytes
- Instruction execution time
 The fastest instruction at 40 MHz frequency 100 ns
- Single power supply 5V ± 10 %
- Low power dissipation (at 40 MHz frequency) 125 mW (Typ.)
- Interrupts 21 types, 7 levels

- Multiple-function 16-bit timer 5+3
 (three-phase motor drive waveform or pulse motor control waveform output)
- Serial I/O (UART or clock synchronous) 2
- 10-bit A-D converter 8-channel inputs
- 8-bit D-A converter 2-channel outputs
- 12-bit watchdog timer
- Programmable input/output
 (ports P0—P8) 68
- Small package [M37753M6C-XXXHP]
 80-pin fine pitch QFP (lead pitch : 0.5 mm)

APPLICATION

Control devices for personal computer peripheral equipment such as CD-ROM drives, hard disk drives, high density FDD, printers
 Control devices for office equipment such as copiers and facsimiles
 Control devices for industrial equipment such as communication and measuring instruments
 Control devices for equipment required for motor control such as inverter air conditioner and general purpose inverter

M37753M6C-XXXFP PIN CONFIGURATION (TOP VIEW)

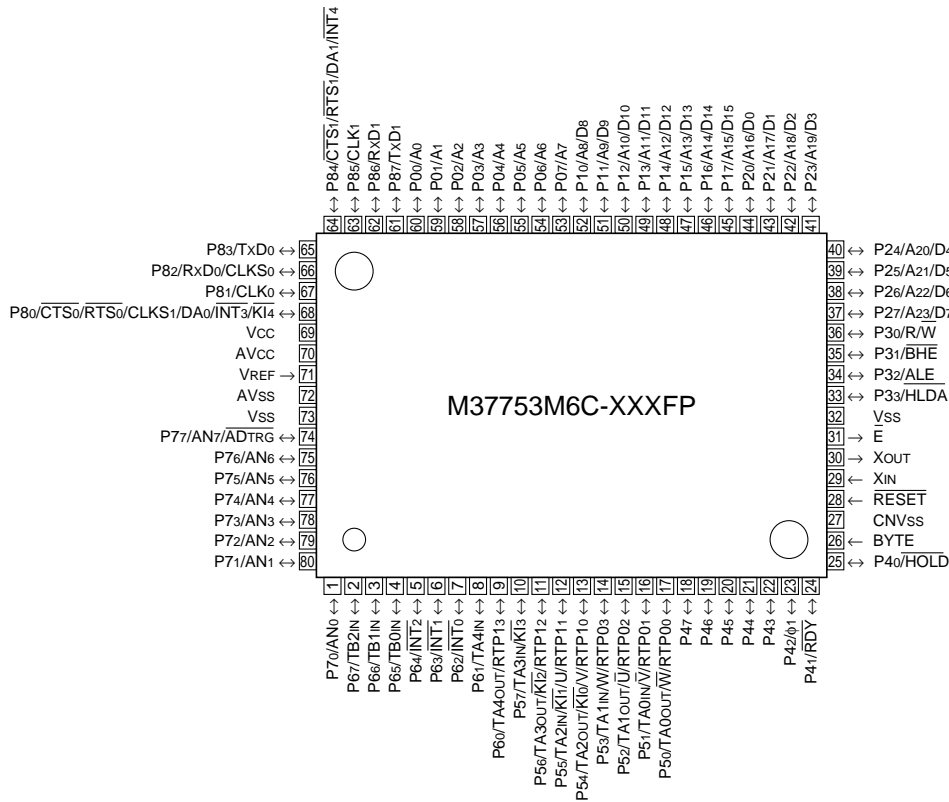

Outline 80P6N-A

PRELIMINARY
 Notice: This is not a final specification.
 Some parametric limits are subject to change.

M37753M6C-XXXFP, M37753M6C-XXXHP

SINGLE-CHIP 16-BIT CMOS MICROCOMPUTER

M37753M6C-XXXHP PIN CONFIGURATION (TOP VIEW)

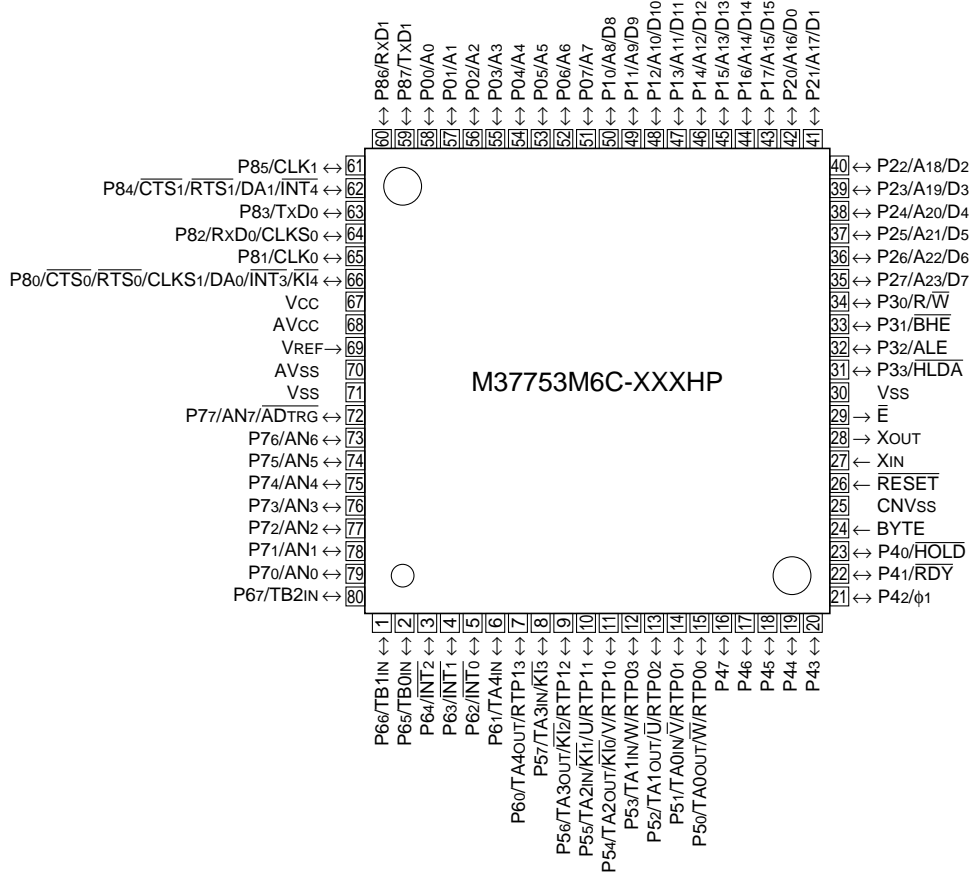

Outline 80P6Q-A

Differences between M37753M6C-XXXFP and M37753M6C-XXXHP

Product	Package
M37753M6C-XXXFP	80-pin QFP (80P6N-A)
M37753M6C-XXXHP	80-pin fine pitch QFP (80P6Q-A)

PRELIMINARY
 Notice: This is not a final specification.
 Some parametric limits are subject to change.

MITSUBISHI MICROCOMPUTERS
M37753M6C-XXXFP, M37753M6C-XXXHP

SINGLE-CHIP 16-BIT CMOS MICROCOMPUTER

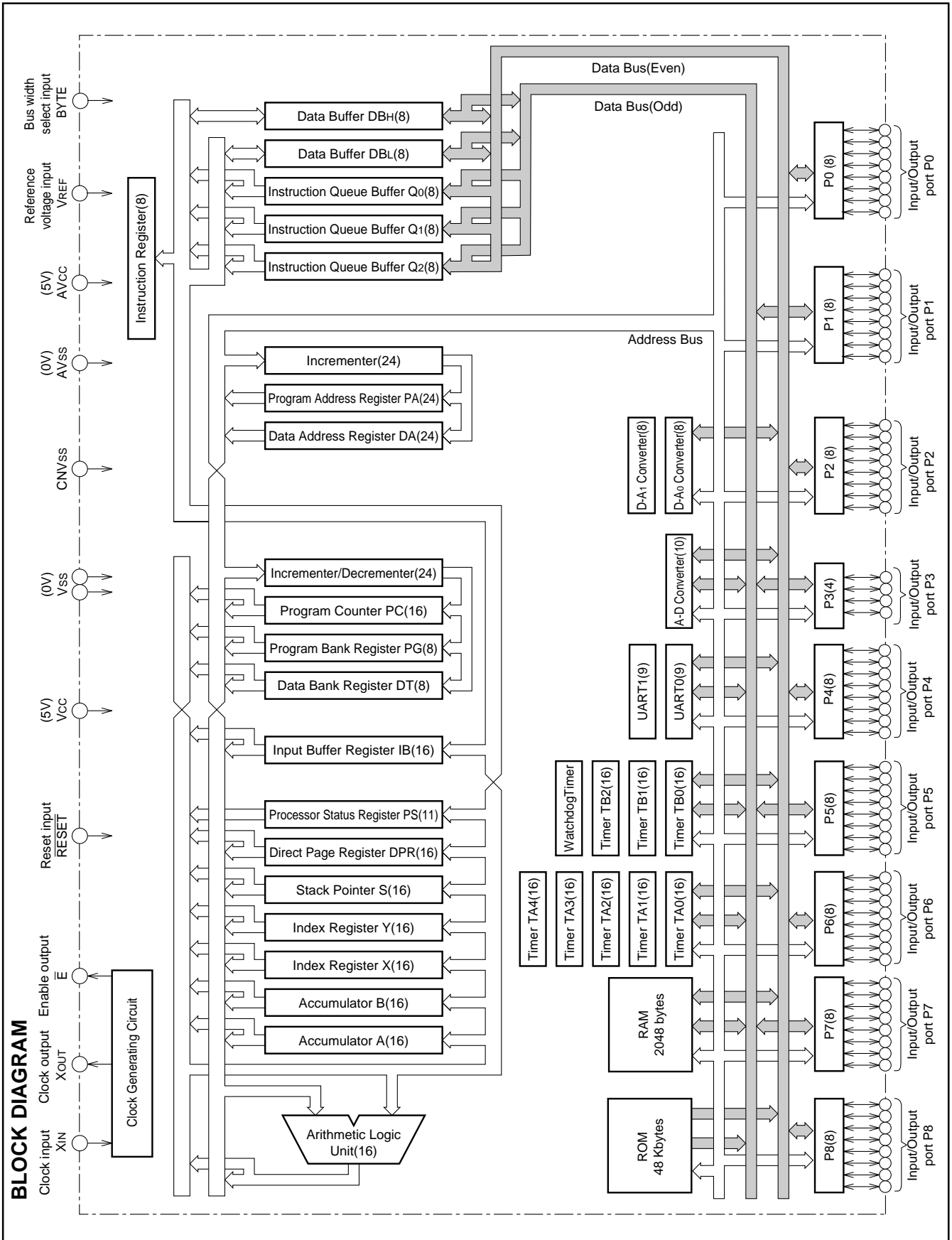

PRELIMINARY
 Notice: This is not a final specification.
 Some parametric limits are subject to change.

MITSUBISHI MICROCOMPUTERS
M37753M6C-XXXFP, M37753M6C-XXXHP

SINGLE-CHIP 16-BIT CMOS MICROCOMPUTER

FUNCTIONS

Parameter		Functions
Number of basic machine instructions		109
Instruction execution time		100 ns (the fastest instruction at external clock 40 MHz frequency)
Memory size	ROM	48 Kbytes
	RAM	2048 bytes
Input/Output ports	P0–P2, P4–P8	8-bit × 8
	P3	4-bit × 1
Multiple-function timers	TA0, TA1, TA2, TA3, TA4	16-bit × 5
	TB0, TB1, TB2	16-bit × 3
Serial I/O		(UART or clock synchronous serial I/O) × 2
A-D converter		10-bit × 1 (8 channels)
D-A converter		8-bit × 2
Watchdog timer		12-bit × 1
Dead-time timer		8-bit × 3
Interrupts		5 external types, 16 internal types (Each interrupt can be set to priority levels 0–7.)
Clock generating circuit		Built-in (externally connected to a ceramic resonator or quartz crystal resonator)
Supply voltage		5 V ± 10 %
Power dissipation		125 mW (at external clock 40 MHz frequency)
Input/Output characteristic	Input/Output withstand voltage	5 V
	Output current	5 mA
Memory expansion		Maximum 16 Mbytes
Operating temperature range		–20 to 85 °C
Device structure		CMOS high-performance silicon gate process
Package		80-pin plastic molded QFP

M37753M6C-XXXFP, M37753M6C-XXXHP

PRELIMINARY
 Notice: This is not a final specification.
 Some parametric limits are subject to change.

SINGLE-CHIP 16-BIT CMOS MICROCOMPUTER

PIN DESCRIPTION

Pin	Name	Input/Output	Functions
VCC, VSS	Power supply		Supply 5 V±10 % to VCC and 0 V to VSS.
CNVSS	CNVSS input	Input	This pin controls the processor mode. Connect to VSS for single-chip mode or memory expansion mode. Connect to VCC for microprocessor mode.
RESET	Reset input	Input	This is reset input pin. The microcomputer is reset when supplying "L" level to this pin.
XIN	Clock input	Input	These are I/O pins of internal clock generating circuit. Connect a ceramic or quartz-crystal resonator between XIN and XOUT. When an external clock is used, the clock source should be connected to the XIN pin and the XOUT pin should be left open.
XOUT	Clock output	Output	
\bar{E}	Enable output	Output	Data or instruction read, data write are performed when output from this pin is "L".
BYTE (Note)	Bus width select input	Input	This pin determines whether the external data bus is 8-bit width or 16-bit width for memory expansion mode or microprocessor mode. The width is 16 bits when "L" signal inputs and 8 bits when "H" signal inputs.
AVCC, AVSS	Analog supply input		Power supply for the A-D converter and the D-A converter. Connect AVCC to VCC and AVSS to VSS externally.
VREF	Reference voltage input	Input	This is reference voltage input pin for the A-D converter and the D-A converter.
P00-P07	I/O port P0	I/O	In single-chip mode, port P0 is an 8-bit I/O port. This port has an I/O direction register and each pin can be programmed for input or output. These ports are in the input mode when reset. Address (A0-A7) is output in memory expansion mode or microprocessor mode.
P10-P17	I/O port P1	I/O	In single-chip mode, these pins have the same functions as port P0. When the BYTE pin is set to "L" in memory expansion mode or microprocessor mode and external data bus is 16-bit width, high-order data (D8-D15) is input or output if \bar{E} output is "L" and an address (A8-A15) is output if \bar{E} output is "H". When the BYTE pin is set to "H" and an external data bus is 8-bit width, only address (A8-A15) is output.
P20-P27	I/O port P2	I/O	In single-chip mode, these pins have the same functions as port P0. In memory expansion mode or microprocessor mode, low-order data (D0-D7) is input or output when \bar{E} output is "L" and an address (A16-A23) is output when \bar{E} output is "H".
P30-P33	I/O port P3	I/O	In single-chip mode, these pins have the same functions as port P0. In memory expansion mode or microprocessor mode, R/W, BHE, ALE, and HLDA signals are output.
P40-P47	I/O port P4	I/O	In single-chip mode, these pins have the same functions as port P0. In memory expansion mode or micro processor mode, P40, P41, and P42 become HOLD and RDY input pins, and clock ϕ 1 output pin respectively. Functions of other pins are the same as in single-chip mode. In memory expansion mode, P42 can be programmed as I/O port.
P50-P57	I/O port P5	I/O	In addition to having the same functions as port P0 in single-chip mode, these pins also function as I/O pins for timer A0, timer A1, timer A2, timer A3, output pins for motor drive waveform, and input pins for key input interrupt.
P60-P67	I/O port P6	I/O	In addition to having the same functions as port P0 in single-chip mode, these pins also function as I/O pins for timer A4, input pins for external interrupt input INT0, INT1, and INT2, and input pins for timer B0, timer B1, and timer B2, and output pin for motor drive wave form.
P70-P77	I/O port P7	I/O	In addition to having the same functions as port P0 in single-chip mode, these pins also function as input pins for A-D converter.
P80-P87	I/O port P8	I/O	In addition to having the same functions as port P0 in single-chip mode, these pins also function as I/O pins for UART0, UART1, output pins for D-A converter, and input pins for INT3, INT4.

Note: It is impossible to change the input level of the BYTE pin in each bus cycle. In other words, bus width cannot be switched dynamically. Fix the input level of the BYTE pin to "H" or "L" according to the bus width used.

BASIC FUNCTION BLOCKS

The M37753M6C-XXXFP and M37753M6C-XXXHP has the same functions as the M37753M8C-XXXFP and M37753M8C-XXXHP except for the following:

- (1) The ROM size is different.
 - (2) The function of ROM area modification is not available.
- Therefore, refer to the section on the M37753M8C-XXXFP.

MEMORY

The memory map is shown in Figure 1. The address space is 16 Mbytes from addresses 016 to FFFFFFF16. The address space is divided into 64-Kbyte units called banks. The banks are numbered from 016 to FF16.

Internal ROM, internal RAM, and control registers for internal peripheral devices are assigned to bank 016.

The 48-Kbyte area from addresses 400016 to FFFF16 is the internal ROM.

Addresses FFD216 to FFFF16 are the RESET and interrupt vector addresses and contain the interrupt vectors. Refer to the section on interrupts for details.

The 2048-byte area from addresses 8016 to 87F16 contains the internal RAM. In addition to storing data, the RAM is used as stack during a subroutine call, or interrupts.

Assigned to addresses 016 to 7F16 are peripheral devices such as I/O ports, A-D converter, D-A converter, UART, timer, and interrupt control registers.

A 256-byte direct page area can be allocated anywhere in bank 016 using the direct page register DPR. In direct page addressing mode, the memory in the direct page area can be accessed with two words thus reducing program steps.

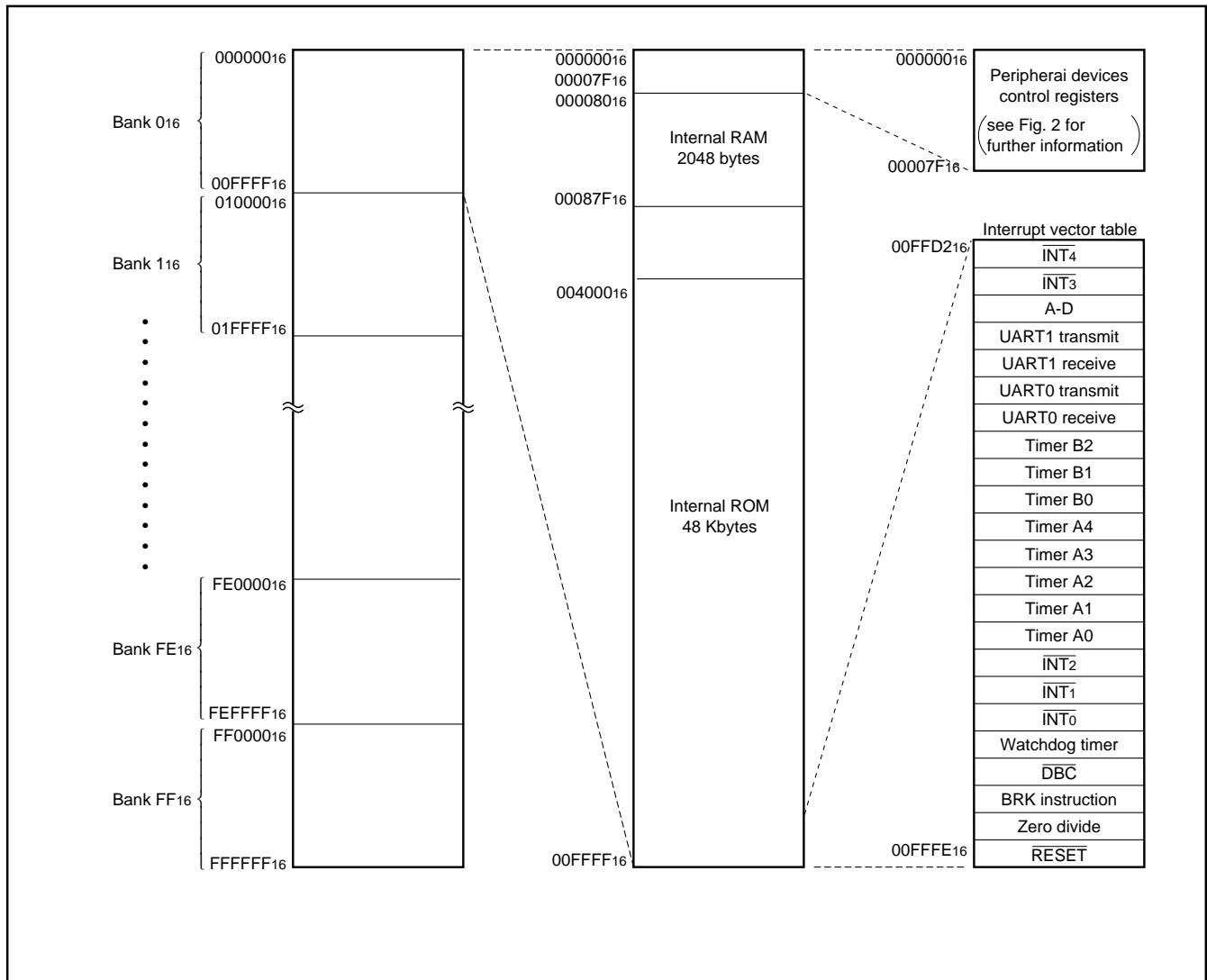

Fig. 1 Memory map

Address (Hexadecimal notation)		Address (Hexadecimal notation)	
000000		000040	Count start register
000001		000041	
000002	Port P0 register	000042	One-shot start register
000003	Port P1 register	000043	
000004	Port P0 direction register	000044	Up-down register
000005	Port P1 direction register	000045	Timer A write register
000006	Port P2 register	000046	Timer A0 register
000007	Port P3 register	000047	
000008	Port P2 direction register	000048	Timer A1 register
000009	Port P3 direction register	000049	
00000A	Port P4 register	00004A	Timer A2 register
00000B	Port P5 register	00004B	
00000C	Port P4 direction register	00004C	Timer A3 register
00000D	Port P5 direction register	00004D	
00000E	Port P6 register	00004E	Timer A4 register
00000F	Port P7 register	00004F	
000010	Port P6 direction register	000050	Timer B0 register
000011	Port P7 direction register	000051	
000012	Port P8 register	000052	Timer B1 register
000013		000053	
000014	Port P8 direction register	000054	Timer B2 register
000015		000055	
000016		000056	Timer A0 mode register
000017		000057	Timer A1 mode register
000018		000058	Timer A2 mode register
000019		000059	Timer A3 mode register
00001A	Waveform output mode register	00005A	Timer A4 mode register
00001B	Dead-time timer	00005B	Timer B0 mode register
00001C	Pulse output data register 1	00005C	Timer B1 mode register
00001D	Pulse output data register 0	00005D	Timer B2 mode register
00001E	A-D control register 0	00005E	Processor mode register 0
00001F	A-D control register 1	00005F	Processor mode register 1
000020	A-D register 0	000060	Watchdog timer register
000021		000061	Watchdog timer frequency select register
000022	A-D register 1	000062	
000023		000063	
000024	A-D register 2	000064	Comparator function select register
000025		000065	Reserved area (Note)
000026	A-D register 3	000066	Comparator result register
000027		000067	Reserved area (Note)
000028	A-D register 4	000068	D-A register 0
000029		000069	
00002A	A-D register 5	00006A	D-A register 1
00002B		00006B	
00002C	A-D register 6	00006C	Particular function select register 0
00002D		00006D	Particular function select register 1
00002E	A-D register 7	00006E	INT ₄ interrupt control register
00002F		00006F	INT ₃ interrupt control register
000030	UART0 transmit/receive mode register	000070	A-D interrupt control register
000031	UART0 baud rate register	000071	UART0 transmit interrupt control register
000032	UART0 transmit buffer register	000072	UART0 receive interrupt control register
000033		000073	UART1 transmit interrupt control register
000034	UART0 transmit/receive control register 0	000074	UART1 receive interrupt control register
000035	UART0 transmit/receive control register 1	000075	Timer A0 interrupt control register
000036	UART0 receive buffer register	000076	Timer A1 interrupt control register
000037		000077	Timer A2 interrupt control register
000038	UART1 transmit/receive mode register	000078	Timer A3 interrupt control register
000039	UART1 baud rate register	000079	Timer A4 interrupt control register
00003A	UART1 transmit buffer register	00007A	Timer B0 interrupt control register
00003B		00007B	Timer B1 interrupt control register
00003C	UART1 transmit/receive control register 0	00007C	Timer B2 interrupt control register
00003D	UART1 transmit/receive control register 1	00007D	INT ₀ interrupt control register
00003E	UART1 receive buffer register	00007E	INT ₁ interrupt control register
00003F		00007F	INT ₂ interrupt control register

Note: Do not write to this address.

Fig. 2 Location of peripheral devices and interrupt control registers

ELECTRICAL CHARACTERISTICS

The M37753M6C-XXXFP and M37753M6C-XXXHP has the same function as the M37753M8C-XXXFP and M37753M8C-XXXHP in for the following :

- (1) ABSOLUTE MAXIMUM RATINGS
- (2) RECOMMENDED OPERATING CONDITIONS
- (3) ELECTRICAL CHARACTERISTICS
- (4) PERIPHERAL DEVICE INPUT/OUTPUT TIMING
- (5) TIMING REQUIREMENTS
- (6) SWITCHING CHARACTERISTICS

Therefore, refer to the corresponding section on the M37753M8C-XXXFP.

ADDRESSING MODES AND INSTRUCTION SET

The M37753M6C-XXXFP and M37753M6C-XXXHP have 29 powerful addressing modes; 1 addressing mode is added to the basis of the 7700 series. Refer to the "7751 Series Software Manual" for the details.

INSTRUCTION SET

The M37753M6C-XXXFP and M37753M6C-XXXHP have the extended instruction set; 6 instructions are added to the instruction set of 7700 series. The object code of this extended instruction set is upwards compatible to that of 7700 series instruction set.

Refer to the "7751 Series Software Manual" for the details.

SHORTENING NUMBER OF INSTRUCTION EXECUTION CYCLES

Shortening number of instruction execution cycles is realized in the M37753M6C-XXXFP and M37753M6C-XXXHP owing to modifications of the instruction execution algorithm and the CPU circuit, and others.

Refer to the "7751 Series Software Manual" about the number of instruction execution cycles.

DATA REQUIRED FOR MASK ROM ORDERING

Please send the following data for mask orders:

<M37753M6C-XXXFP>

- (1) M37753M6C-XXXFP mask ROM order confirmation form
- (2) 80P6N mark specification form
- (3) ROM data (EPROM 3 sets)

<M37753M6C-XXXHP>

- (1) M37753M6C-XXXHP mask ROM order confirmation form
- (2) 80P6Q mark specification form
- (3) ROM data (EPROM 3 sets)

**7700 FAMILY MASK ROM ORDER CONFIRMATION FORM
SINGLE-CHIP 16-BIT MICROCOMPUTER
M37753M6C-XXXFP
M37753M6C-XXXHP
MITSUBISHI ELECTRIC**

Mask ROM number	
-----------------	--

Receipt	Date:	
	Section head signature	Supervisor signature

Note : Please fill in all items marked ※

※	Customer	Company name	TEL ()	Issuance signatures	Responsible officer	Supervisor
		Date issued	Date:			

※1. Confirmation

Specify the name of the product being ordered.

Three sets of EPROMs are required for each pattern (Check @ in the appropriate box).

If at least two of the three sets of EPROMs submitted contain the identical data, we will produce masks based on this data.

We shall assume the responsibility for errors only if the mask ROM data on the products we produce differ from this data.

Thus, the customer must be especially careful in verifying the data contained in the EPROMs submitted.

Checksum code for entire EPROM areas

--	--	--	--

 (hexadecimal notation)

EPROM Type :

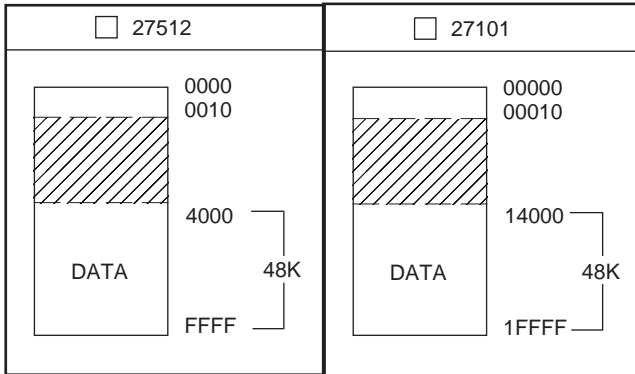

(1) Set "FF₁₆" in the shaded area.

(2) Address 0₁₆ to 10₁₆ are the area for storing the data on model designation and options. This area must be written with the data shown below.

Details for option data are given next in the section describing the STP instruction option.

Address and data are written in hexadecimal notation.

Address	Address	Address			
4D	0	43	8	Option data	10
33	1	2D	9		
37	2	FF	A		
37	3	FF	B		
35	4	FF	C		
33	5	FF	D		
4D	6	FF	E		
36	7	FF	F		

※2. STP instruction option

One of the following sets of data should be written to the option data address (10₁₆) of the EPROM you have ordered.

Check @ in the appropriate box.

STP instruction enable Address 10₁₆
 STP instruction disable Address 10₁₆

※3. Mark specification

Mark specification must be submitted using the correct form for the type of package being ordered fill out the appropriate 80P6N Mark Specification Form (for M37753M6C-XXXFP), 80P6Q Mark Specification Form (for M37753M6C-XXXHP) and attach to the Mask ROM Order Confirmation Form.

※4. Comments

80P6N (80-PIN QFP) MARK SPECIFICATION FORM

Mitsubishi IC catalog name

Please choose one of the marking types below (A, B, C), and enter the Mitsubishi IC catalog name and the special mark (if needed).

A. Standard Mitsubishi Mark

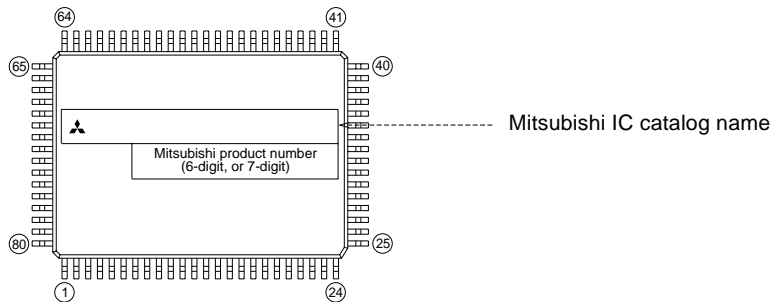

B. Customer's Parts Number + Mitsubishi IC Catalog Name

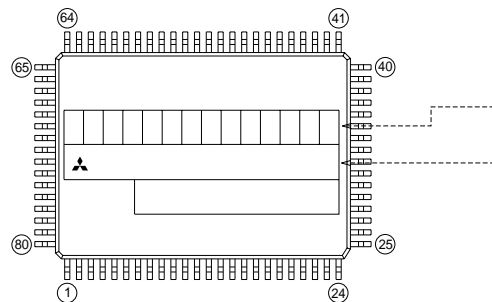

Customer's Parts Number

Note : The fonts and size of characters are standard Mitsubishi type.

Mitsubishi IC catalog name

Notes 1 : The mark field should be written right aligned.

2 : The fonts and size of characters are standard Mitsubishi type.

3 : Customer's parts number can be up to 14 alphanumeric characters for capital letters, hyphens, commas, periods and so on.

4 : If the Mitsubishi logo is not required, check the box below.

Mitsubishi logo is not required

C. Special Mark Required

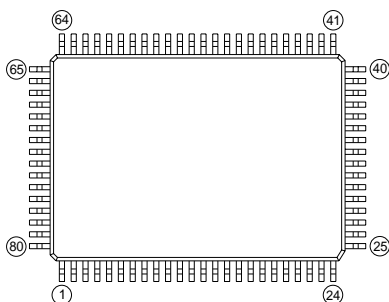

Notes1 : If special mark is to be printed, indicate the desired layout of the mark in the left figure. The layout will be duplicated technically as close as possible.

Mitsubishi product number (6-digit, or 7-digit) and Mask ROM number (3-digit) are always marked for sorting the products.

2 : If special character fonts (e.g., customer's trade mark logo) must be used in Special Mark, check the box below.

For the new special character fonts, a clean font original (ideally logo drawing) must be submitted.

Special character fonts required

Keep safety first in your circuit designs!

- Mitsubishi Electric Corporation puts the maximum effort into making semiconductor products better and more reliable, but there is always the possibility that trouble may occur with them. Trouble with semiconductors may lead to personal injury, fire or property damage. Remember to give due consideration to safety when making your circuit designs, with appropriate measures such as (i) placement of substitutive, auxiliary circuits, (ii) use of non-flammable material or (iii) prevention against any malfunction or mishap.

Notes regarding these materials

- These materials are intended as a reference to assist our customers in the selection of the Mitsubishi semiconductor product best suited to the customer's application; they do not convey any license under any intellectual property rights, or any other rights, belonging to Mitsubishi Electric Corporation or a third party.
- Mitsubishi Electric Corporation assumes no responsibility for any damage, or infringement of any third-party's rights, originating in the use of any product data, diagrams, charts or circuit application examples contained in these materials.
- All information contained in these materials, including product data, diagrams and charts, represent information on products at the time of publication of these materials, and are subject to change by Mitsubishi Electric Corporation without notice due to product improvements or other reasons. It is therefore recommended that customers contact Mitsubishi Electric Corporation or an authorized Mitsubishi Semiconductor product distributor for the latest product information before purchasing a product listed herein.
- Mitsubishi Electric Corporation semiconductors are not designed or manufactured for use in a device or system that is used under circumstances in which human life is potentially at stake. Please contact Mitsubishi Electric Corporation or an authorized Mitsubishi Semiconductor product distributor when considering the use of a product contained herein for any specific purposes, such as apparatus or systems for transportation, vehicular, medical, aerospace, nuclear, or undersea repeater use.
- The prior written approval of Mitsubishi Electric Corporation is necessary to reprint or reproduce in whole or in part these materials.
- If these products or technologies are subject to the Japanese export control restrictions, they must be exported under a license from the Japanese government and cannot be imported into a country other than the approved destination.
Any diversion or reexport contrary to the export control laws and regulations of Japan and/or the country of destination is prohibited.
- Please contact Mitsubishi Electric Corporation or an authorized Mitsubishi Semiconductor product distributor for further details on these materials or the products contained therein.

REVISION DESCRIPTION LIST

M37753M6C-XXXFP/HP DATA SHEET

Rev. No.	Revision Description	Rev. date
1.0	First Edition	971114
1.01	The following are added: <ul style="list-style-type: none">•MASK ROM ORDER CONFIRMATION FORM•MARK SPECIFICATION FORM	980528
2.00	(1) For the “timer A write flag (address 45 ₁₆)”, it’s name and it’s bit name are corrected: <ul style="list-style-type: none">• New register name: timer A write <u>register</u>• Related page: page 7	990428