

FD1000FV-90

HIGH POWER, HIGH FREQUENCY,
PRESS PACK TYPE

FD1000FV-90



- IF(AV) Average forward current 800A
- VRRM Repetitive peak reverse voltage 3500 ~ 4500V
- QRR Reverse recovery charge 1500μC
- Press pack type

OUTLINE DRAWING

Dimensions in mm

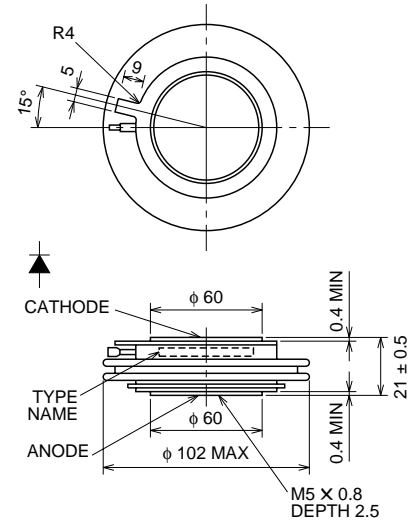

APPLICATION

High-power inverters, Fly-wheel diodes in DC choppers, Power supplies as high frequency rectifiers

MAXIMUM RATINGS

Symbol	Parameter	Voltage class			Unit
		70	80	90	
VRRM	Repetitive peak reverse voltage	3500	4000	4500	V
VRSM	Non-repetitive peak reverse voltage	3500	4000	4500	V
VR(DC)	DC reverse voltage	2800	3200	3600	V

Symbol	Parameter	Conditions	Ratings	Unit
IF(RMS)	RMS forward current		1250	A
IF(AV)	Average forward current	f = 60Hz, sine wave $\theta = 180^\circ$, $T_f = 88^\circ\text{C}$	800	A
IFSM	Surge forward current	One half cycle at 60Hz, non-repetitive	20	kA
I^2t	Current-squared, time integration	One cycle at 60Hz	1.7×10^6	A ² s
T_j	Junction temperature		-40 ~ +125	°C
T_{stg}	Storage temperature		-40 ~ +150	°C
—	Mounting force required	Recommended value 39.2	26.5 ~ 43.1	kN
—	Weight	Standard value	700	g

ELECTRICAL CHARACTERISTICS

Symbol	Parameter	Test conditions	Limits			Unit
			Min	Typ	Max	
IRRM	Repetitive peak reverse current	$T_j = 125^\circ\text{C}$, VRRM Applied	—	—	150	mA
VFM	Forward voltage	$T_j = 125^\circ\text{C}$, IFM = 2500A, Instantaneous measurement	—	—	3.0	V
QRR	Reverse recovery charge	IFM = 800A, $di/dt = -30\text{A}/\mu\text{s}$, VR = 150V, $T_j = 125^\circ\text{C}$	—	—	1500	μC
Rth(j-f)	Thermal resistance	Junction to fin	—	—	0.017	°C/W

FD1000FV-90

HIGH POWER, HIGH FREQUENCY,
PRESS PACK TYPE

PERFORMANCE CURVES

MAXIMUM FORWARD CHARACTERISTICS

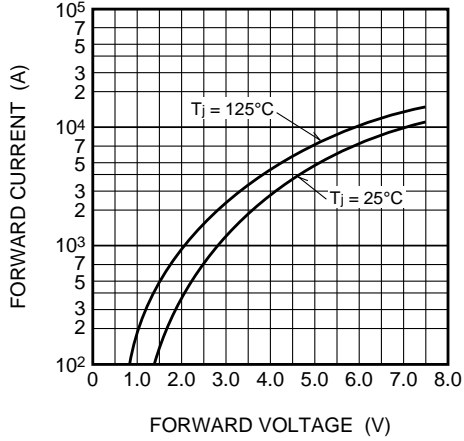

RATED SURGE FORWARD CURRENT

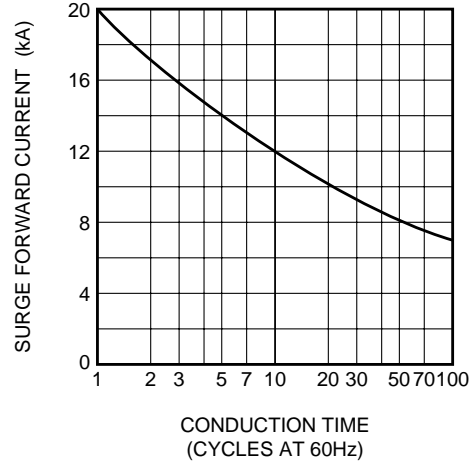

MAXIMUM THERMAL IMPEDANCE CHARACTERISTIC (JUNCTION TO FIN)

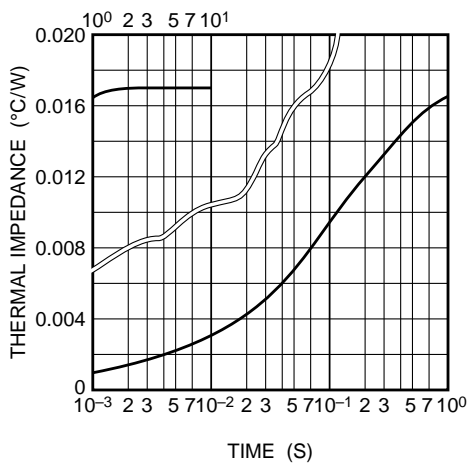

MAXIMUM POWER DISSIPATION CHARACTERISTICS

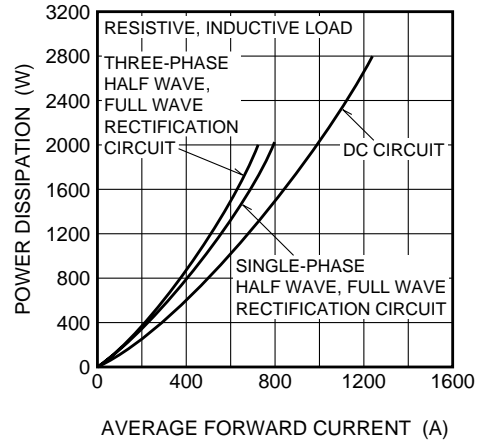

ALLOWABLE FIN TEMPERATURE VS. AVERAGE FORWARD CURRENT

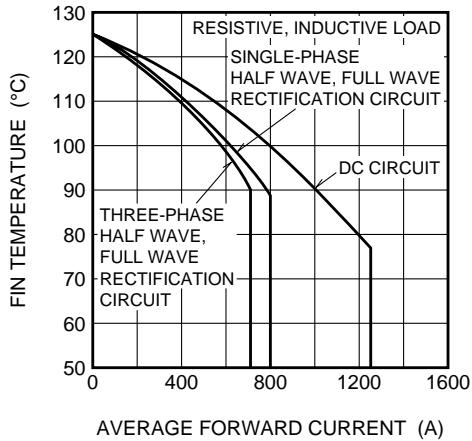

REVERSE RECOVERY CHARGE, REVERSE RECOVERY TIME VS. JUNCTION TEMPERATURE

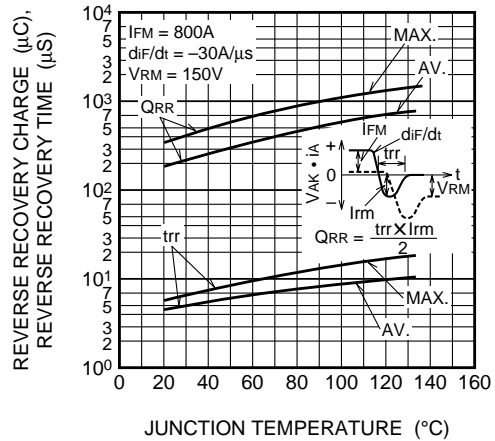

FD1000FV-90

HIGH POWER, HIGH FREQUENCY,
PRESS PACK TYPE

**REVERSE RECOVERY CHARGE,
REVERSE RECOVERY TIME VS.
FORWARD CURRENT**

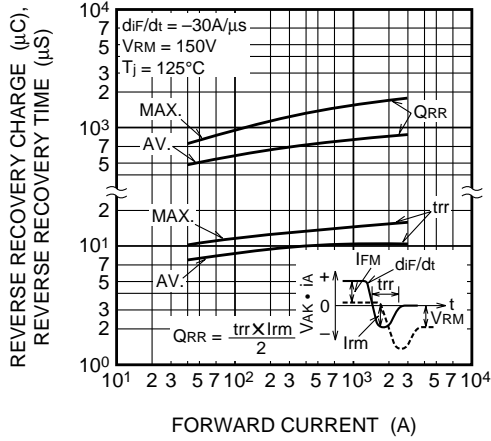

**REVERSE RECOVERY CHARGE,
REVERSE RECOVERY TIME VS. RATE
OF DECREASE OF REVERSE CURRENT**

