

MITSUBISHI Nch POWER MOSFET

FS10KMH-03

HIGH-SPEED SWITCHING USE

FS10KMH-03



- 2.5V DRIVE
- V_{DSS} 30V
- r_{DS (ON)} (MAX) 92mΩ
- I_D 10A
- Integrated Fast Recovery Diode (TYP.) 35ns
- V_{iso} 2000V

OUTLINE DRAWING

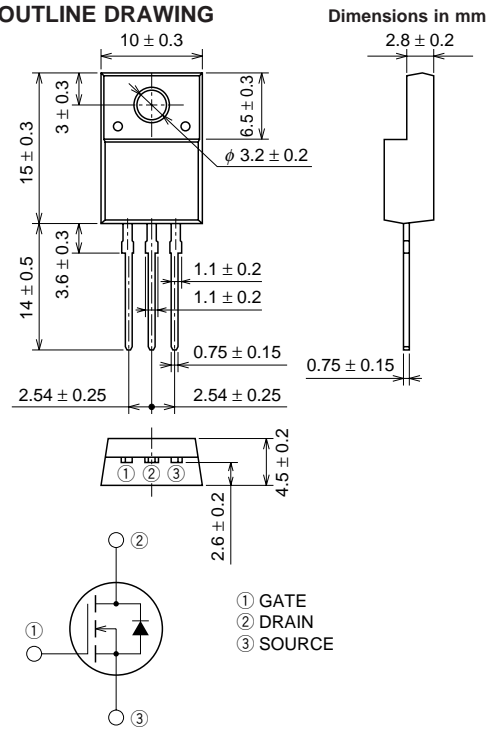

TO-220FN

APPLICATION

Motor control, Lamp control, Solenoid control
DC-DC converter, etc.

MAXIMUM RATINGS (T_c = 25°C)

Symbol	Parameter	Conditions	Ratings	Unit
V _{DSS}	Drain-source voltage	V _{GS} = 0V	30	V
V _{GSS}	Gate-source voltage	V _{DS} = 0V	±10	V
I _D	Drain current		10	A
I _{DM}	Drain current (Pulsed)		40	A
I _{DA}	Avalanche drain current (Pulsed)	L = 30μH	10	A
I _S	Source current		10	A
I _{SM}	Source current (Pulsed)		40	A
P _D	Maximum power dissipation		15	W
T _{ch}	Channel temperature		-55 ~ +150	°C
T _{stg}	Storage temperature		-55 ~ +150	°C
V _{iso}	Isolation voltage	AC for 1minute, Terminal to case	2000	V
—	Weight	Typical value	2.0	g

Feb.1999

FS10KMH-03

HIGH-SPEED SWITCHING USE

ELECTRICAL CHARACTERISTICS (T_{ch} = 25°C)

Symbol	Parameter	Test conditions	Limits			Unit
			Min.	Typ.	Max.	
V (BR) DSS	Drain-source breakdown voltage	I _D = 1mA, V _{GS} = 0V	30	—	—	V
I _{GSS}	Gate-source leakage current	V _{GS} = ±10V, V _{DS} = 0V	—	—	±0.1	μA
I _{DSS}	Drain-source leakage current	V _{DS} = 30V, V _{GS} = 0V	—	—	0.1	mA
V _{GS} (th)	Gate-source threshold voltage	I _D = 1mA, V _{DS} = 10V	0.6	0.9	1.2	V
r _{DS} (ON)	Drain-source on-state resistance	I _D = 5A, V _{GS} = 4V	—	68	92	mΩ
r _{DS} (ON)	Drain-source on-state resistance	I _D = 5A, V _{GS} = 2.5V	—	88	141	mΩ
V _{DS} (ON)	Drain-source on-state voltage	I _D = 5A, V _{GS} = 4V	—	0.34	0.46	V
y _{fs}	Forward transfer admittance	I _D = 5A, V _{DS} = 5V	—	12	—	S
C _{iss}	Input capacitance	V _{DS} = 10V, V _{GS} = 0V, f = 1MHz	—	540	—	pF
C _{oss}	Output capacitance		—	160	—	pF
C _{rss}	Reverse transfer capacitance		—	55	—	pF
t _d (on)	Turn-on delay time	V _{DD} = 15V, I _D = 5A, V _{GS} = 4V, R _{GEN} = R _{GS} = 50Ω	—	12	—	ns
t _r	Rise time		—	35	—	ns
t _d (off)	Turn-off delay time		—	45	—	ns
t _f	Fall time		—	40	—	ns
V _{SD}	Source-drain voltage	I _S = 5A, V _{GS} = 0V	—	1.0	1.5	V
R _{th} (ch-c)	Thermal resistance	Channel to case	—	—	8.3	°C/W
t _{rr}	Reverse recovery time	I _S = 5A, di _s /dt = -50A/μs	—	35	—	ns

PERFORMANCE CURVES

POWER DISSIPATION DERATING CURVE

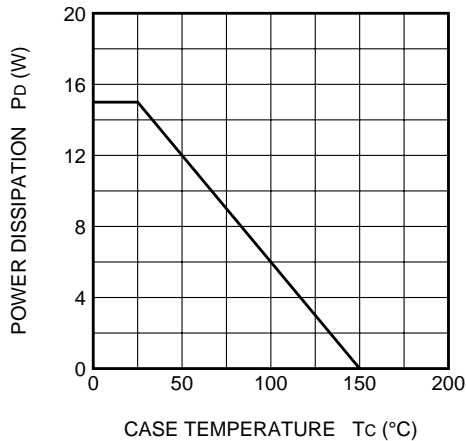

MAXIMUM SAFE OPERATING AREA

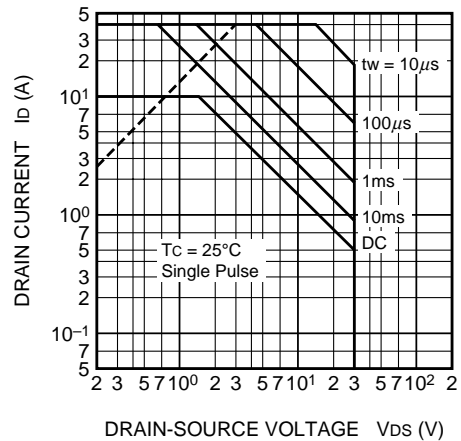

OUTPUT CHARACTERISTICS (TYPICAL)

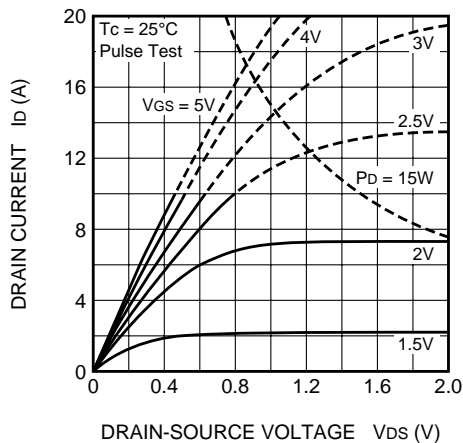

OUTPUT CHARACTERISTICS (TYPICAL)

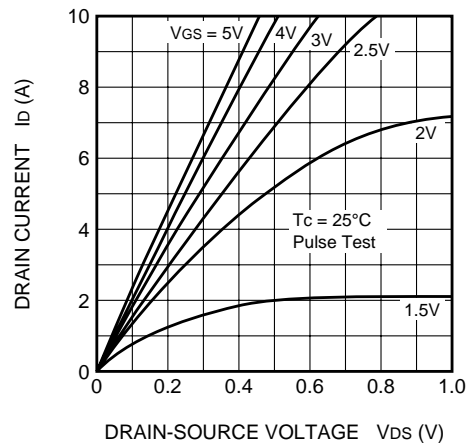

FS10KMH-03

HIGH-SPEED SWITCHING USE

ON-STATE VOLTAGE VS. GATE-SOURCE VOLTAGE (TYPICAL)

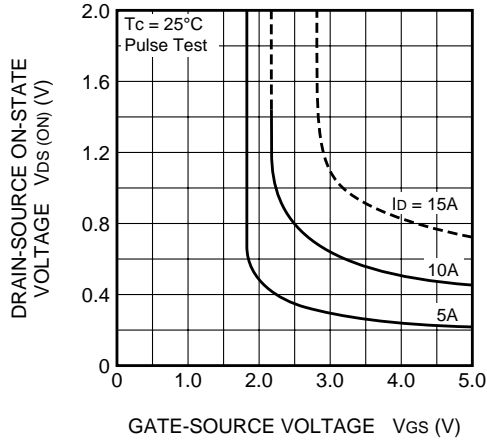

ON-STATE RESISTANCE VS. DRAIN CURRENT (TYPICAL)

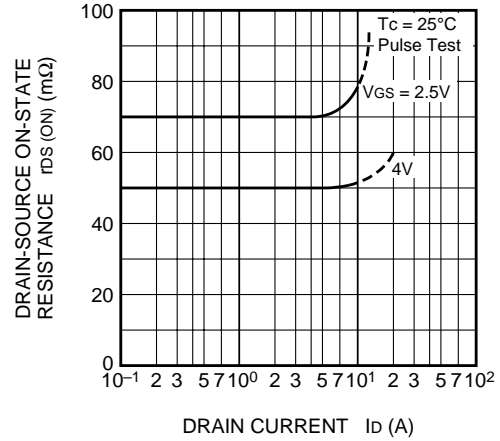

TRANSFER CHARACTERISTICS (TYPICAL)

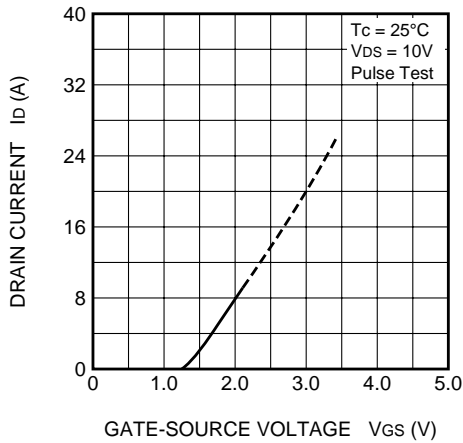

FORWARD TRANSFER ADMITTANCE VS. DRAIN CURRENT (TYPICAL)

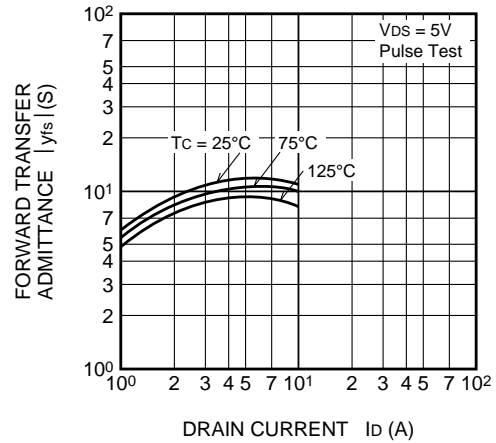

CAPACITANCE VS. DRAIN-SOURCE VOLTAGE (TYPICAL)

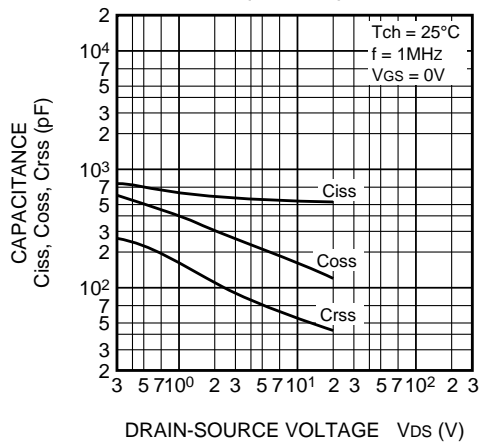

SWITCHING CHARACTERISTICS (TYPICAL)

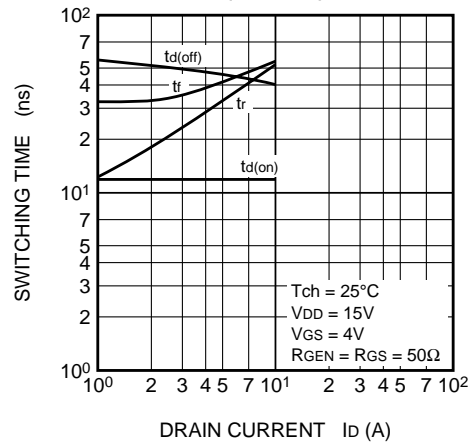

GATE-SOURCE VOLTAGE VS. GATE CHARGE (TYPICAL)

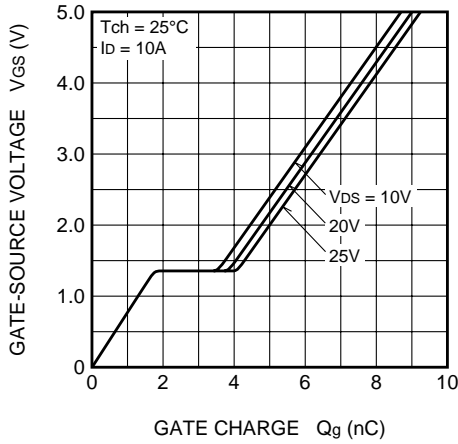

SOURCE-DRAIN DIODE FORWARD CHARACTERISTICS (TYPICAL)

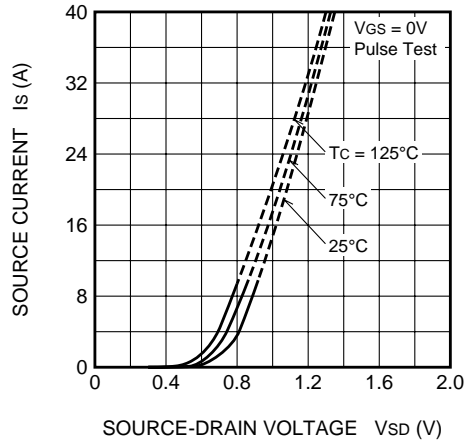

ON-STATE RESISTANCE VS. CHANNEL TEMPERATURE (TYPICAL)

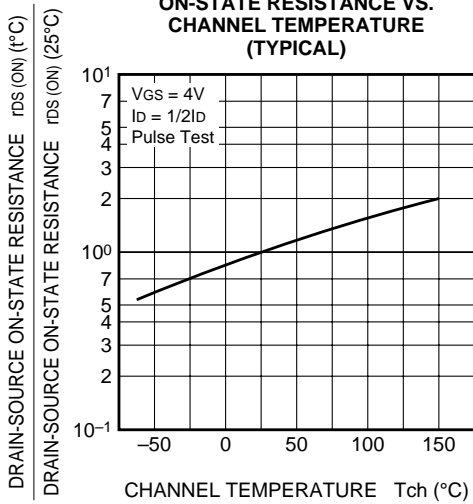

THRESHOLD VOLTAGE VS. CHANNEL TEMPERATURE (TYPICAL)

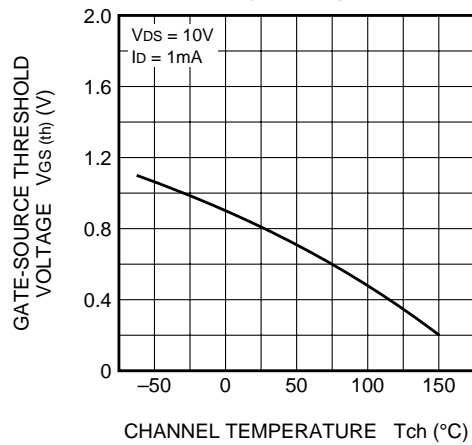

BREAKDOWN VOLTAGE VS. CHANNEL TEMPERATURE (TYPICAL)

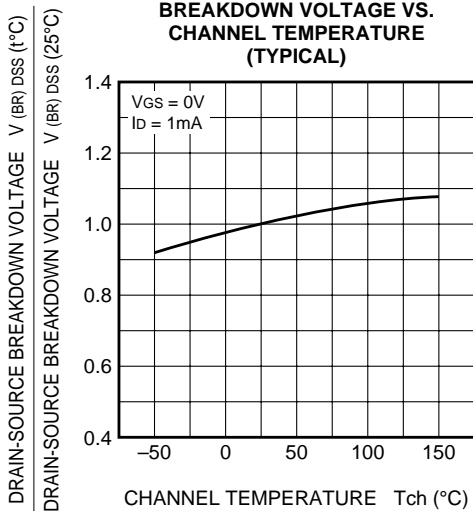

TRANSIENT THERMAL IMPEDANCE CHARACTERISTICS

