

# FS30AS-2

HIGH-SPEED SWITCHING USE

**FS30AS-2**



- 10V DRIVE
- $V_{DSS}$  ..... 100V
- $r_{DS(ON)}(MAX)$  ..... 100m $\Omega$
- $I_D$  ..... 30A
- Integrated Fast Recovery Diode (TYP.) ..... 95ns

**OUTLINE DRAWING** Dimensions in mm

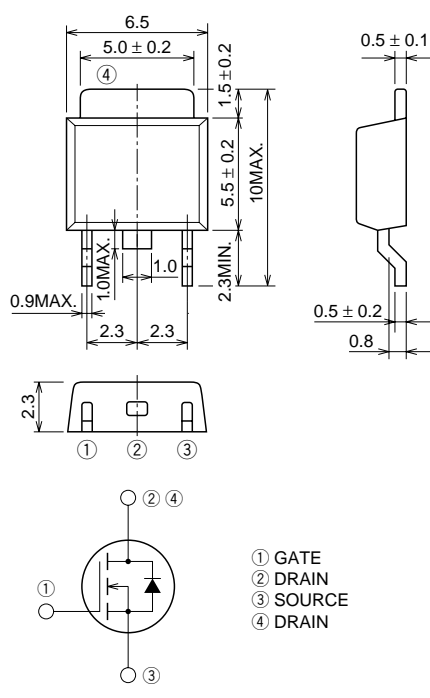

① GATE  
② DRAIN  
③ SOURCE  
④ DRAIN

**MP-3**

## APPLICATION

Motor control, Lamp control, Solenoid control  
DC-DC converter, etc.

## MAXIMUM RATINGS (Tc = 25°C)

Symbol	Parameter	Conditions	Ratings	Unit
$V_{DSS}$	Drain-source voltage	$V_{GS} = 0V$	100	V
$V_{GSS}$	Gate-source voltage	$V_{DS} = 0V$	$\pm 20$	V
$I_D$	Drain current		30	A
$I_{DM}$	Drain current (Pulsed)		120	A
$I_{DA}$	Avalanche drain current (Pulsed)	$L = 100\mu H$	30	A
$I_S$	Source current		30	A
$I_{SM}$	Source current (Pulsed)		120	A
$P_D$	Maximum power dissipation		35	W
$T_{ch}$	Channel temperature		-55 ~ +150	°C
$T_{stg}$	Storage temperature		-55 ~ +150	°C
—	Weight	Typical value	0.26	g

**ELECTRICAL CHARACTERISTICS** (Tch = 25°C)

Symbol	Parameter	Test conditions	Limits			Unit
			Min.	Typ.	Max.	
V(BR)DSS	Drain-source breakdown voltage	Id = 1mA, VGS = 0V	100	—	—	V
IGSS	Gate-source leakage current	VGS = ±20V, VDS = 0V	—	—	±0.1	μA
IDSS	Drain-source leakage current	VDS = 100V, VGS = 0V	—	—	0.1	mA
VGS(th)	Gate-source threshold voltage	Id = 1mA, VDS = 10V	2.0	3.0	4.0	V
rDS(ON)	Drain-source on-state resistance	Id = 15A, VGS = 10V	—	69	100	mΩ
VDS(ON)	Drain-source on-state voltage	Id = 15A, VGS = 10V	—	1.04	1.50	V
yfs	Forward transfer admittance	Id = 15A, VDS = 10V	—	18	—	S
Ciss	Input capacitance	VDS = 10V, VGS = 0V, f = 1MHz	—	1250	—	pF
Coss	Output capacitance		—	230	—	pF
Crss	Reverse transfer capacitance		—	105	—	pF
td(on)	Turn-on delay time	VDD = 50V, Id = 15A, VGS = 10V, RGEN = RGS = 50Ω	—	25	—	ns
tr	Rise time		—	60	—	ns
td(off)	Turn-off delay time		—	60	—	ns
tf	Fall time		—	50	—	ns
VSD	Source-drain voltage	IS = 15A, VGS = 0V	—	1.0	1.5	V
Rth(ch-c)	Thermal resistance	Channel to case	—	—	3.57	°C/W
trr	Reverse recovery time	IS = 30A, dis/dt = -100A/μs	—	95	—	ns

**PERFORMANCE CURVES**

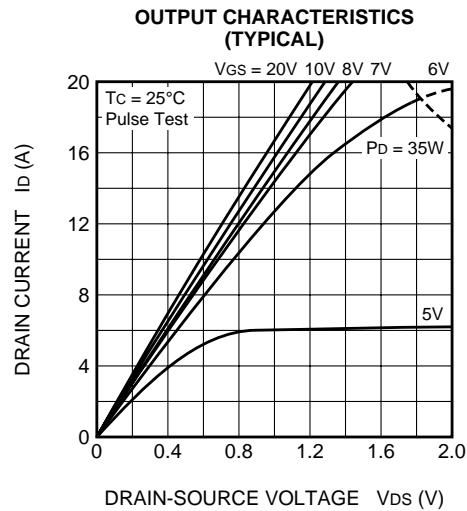
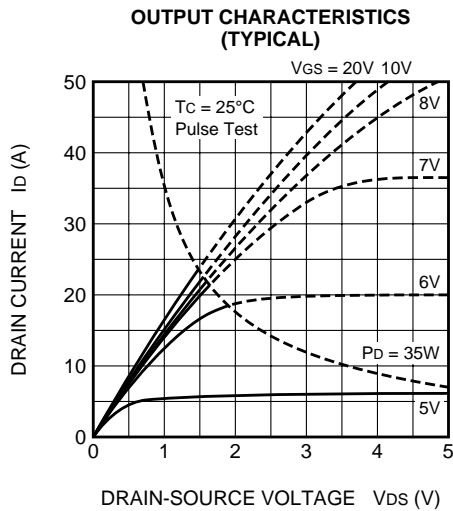
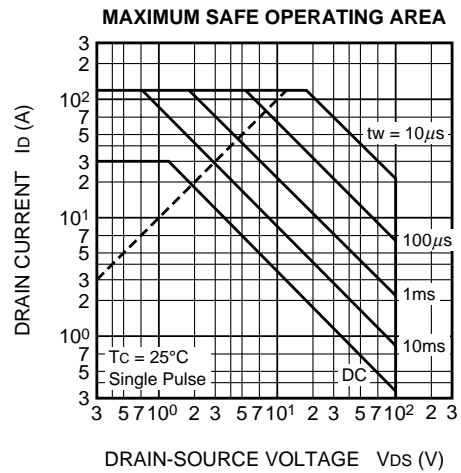
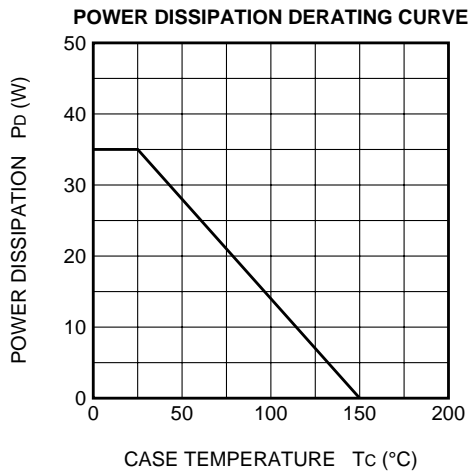

ON-STATE VOLTAGE VS. GATE-SOURCE VOLTAGE (TYPICAL)

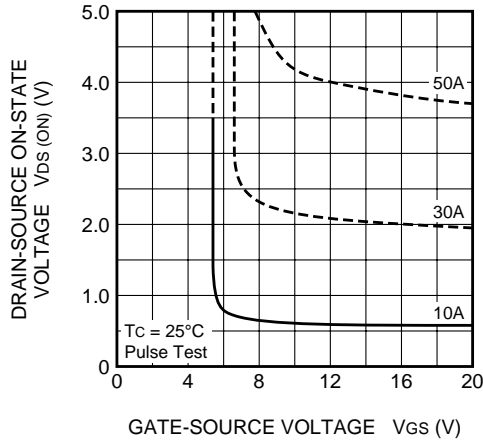

ON-STATE RESISTANCE VS. DRAIN CURRENT (TYPICAL)

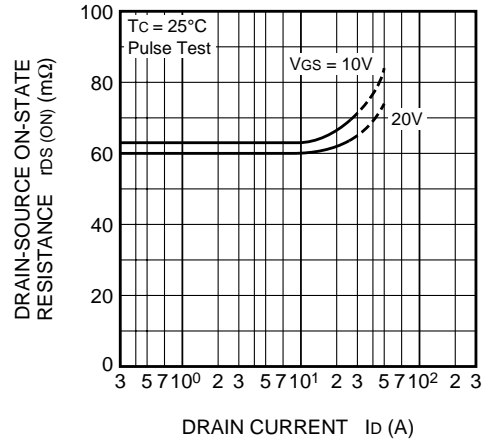

TRANSFER CHARACTERISTICS (TYPICAL)

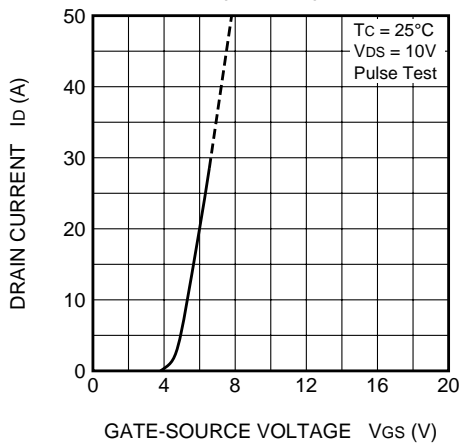

FORWARD TRANSFER ADMITTANCE VS. DRAIN CURRENT (TYPICAL)

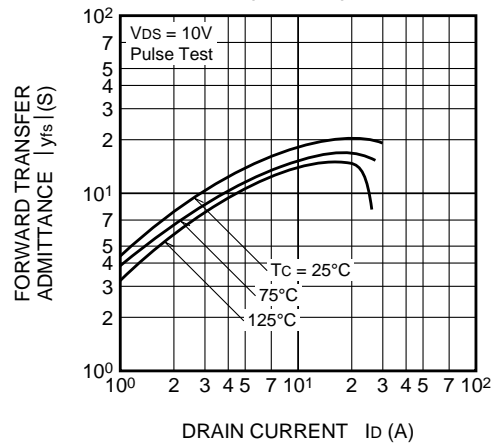

CAPACITANCE VS. DRAIN-SOURCE VOLTAGE (TYPICAL)

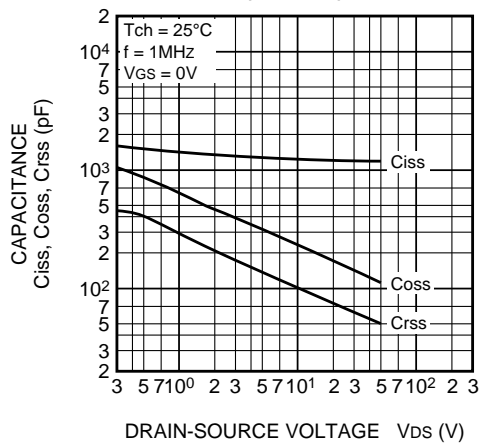

SWITCHING CHARACTERISTICS (TYPICAL)

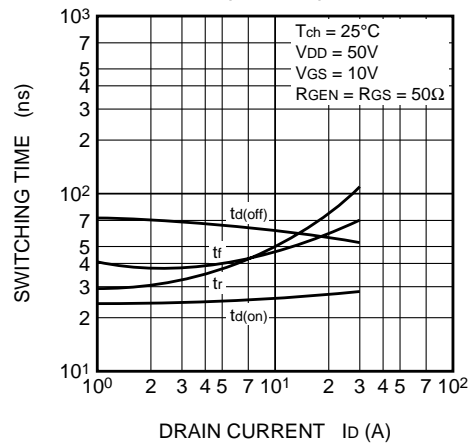

**GATE-SOURCE VOLTAGE VS. GATE CHARGE (TYPICAL)**

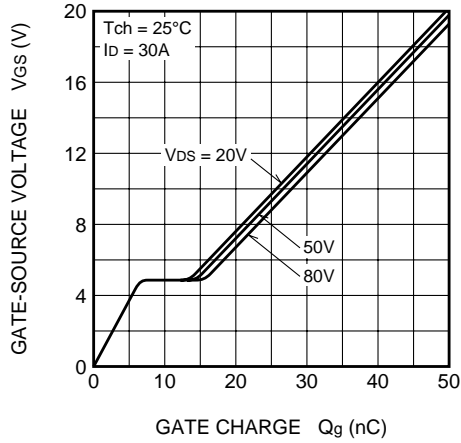

**SOURCE-DRAIN DIODE FORWARD CHARACTERISTICS (TYPICAL)**

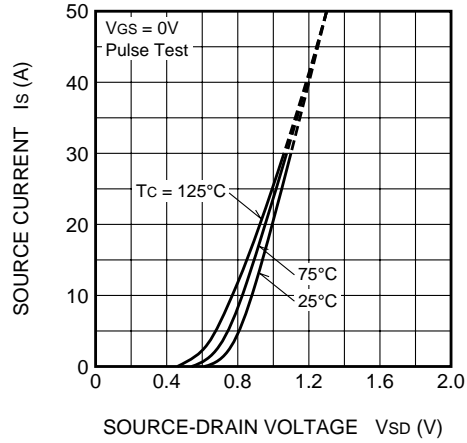

**ON-STATE RESISTANCE VS. CHANNEL TEMPERATURE (TYPICAL)**

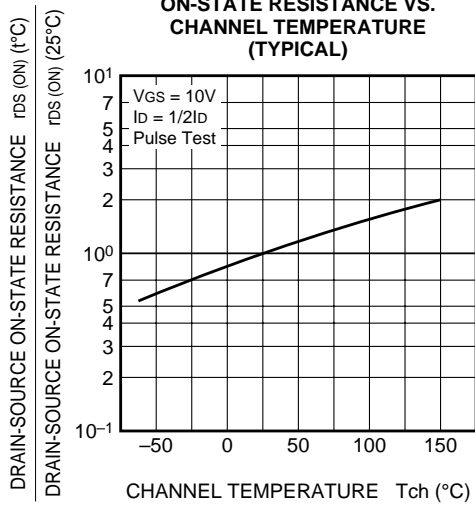

**THRESHOLD VOLTAGE VS. CHANNEL TEMPERATURE (TYPICAL)**

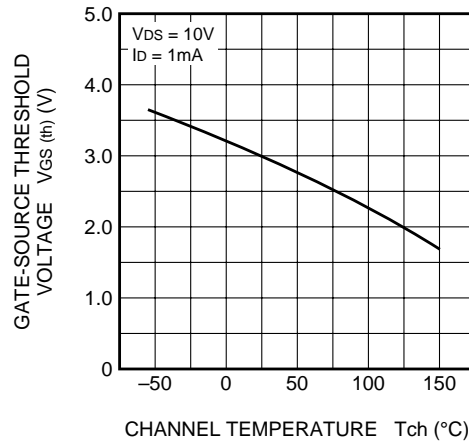

**BREAKDOWN VOLTAGE VS. CHANNEL TEMPERATURE (TYPICAL)**

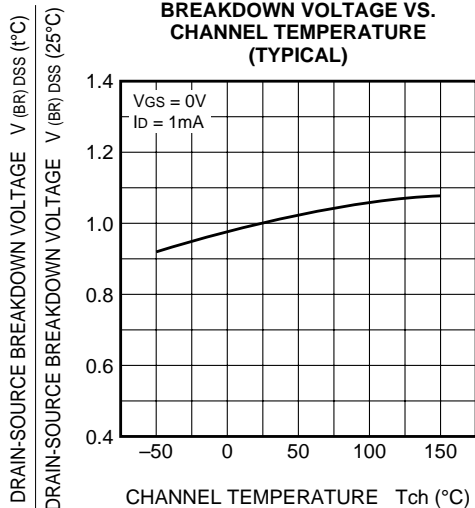

**TRANSIENT THERMAL IMPEDANCE CHARACTERISTICS**

