

# FS12VS-5

HIGH-SPEED SWITCHING USE

**FS12VS-5**



- $V_{DSS}$  ..... 250V
- $r_{DS(ON)}$  (MAX) .....  $0.40\Omega$
- $I_D$  ..... 12A

**OUTLINE DRAWING** Dimensions in mm

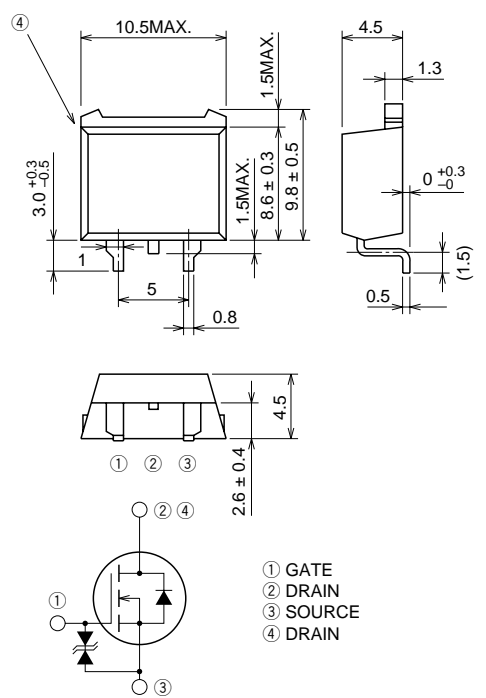

① GATE  
② DRAIN  
③ SOURCE  
④ DRAIN

**TO-220S**

**APPLICATION**

SMPS, DC-DC Converter, battery charger, power supply of printer, copier, HDD, FDD, TV, VCR, personal computer etc.

**MAXIMUM RATINGS** ( $T_c = 25^\circ\text{C}$ )

Symbol	Parameter	Conditions	Ratings	Unit
$V_{DSS}$	Drain-source voltage	$V_{GS} = 0V$	250	V
$V_{GSS}$	Gate-source voltage	$V_{DS} = 0V$	$\pm 30$	V
$I_D$	Drain current		12	A
$I_{DM}$	Drain current (Pulsed)		36	A
$P_D$	Maximum power dissipation		100	W
$T_{ch}$	Channel temperature		$-55 \sim +150$	$^\circ\text{C}$
$T_{stg}$	Storage temperature		$-55 \sim +150$	$^\circ\text{C}$
—	Weight	Typical value	1.2	g

**ELECTRICAL CHARACTERISTICS** (T<sub>ch</sub> = 25°C)

Symbol	Parameter	Test conditions	Limits			Unit
			Min.	Typ.	Max.	
V (BR) DSS	Drain-source breakdown voltage	I <sub>D</sub> = 1mA, V <sub>GS</sub> = 0V	250	—	—	V
V (BR) GSS	Gate-source breakdown voltage	I <sub>G</sub> = ±100μA, V <sub>DS</sub> = 0V	±30	—	—	V
I <sub>GSS</sub>	Gate-source leakage current	V <sub>GS</sub> = ±25V, V <sub>DS</sub> = 0V	—	—	±10	μA
I <sub>DSS</sub>	Drain-source leakage current	V <sub>DS</sub> = 250V, V <sub>GS</sub> = 0V	—	—	1	mA
V <sub>GS</sub> (th)	Gate-source threshold voltage	I <sub>D</sub> = 1mA, V <sub>DS</sub> = 10V	2	3	4	V
r <sub>DS</sub> (ON)	Drain-source on-state resistance	I <sub>D</sub> = 6A, V <sub>GS</sub> = 10V	—	0.32	0.40	Ω
V <sub>DS</sub> (ON)	Drain-source on-state voltage	I <sub>D</sub> = 6A, V <sub>GS</sub> = 10V	—	1.90	2.40	V
y <sub>fs</sub>	Forward transfer admittance	I <sub>D</sub> = 6A, V <sub>DS</sub> = 10V	5.0	7.5	—	S
C <sub>iss</sub>	Input capacitance	V <sub>DS</sub> = 25V, V <sub>GS</sub> = 0V, f = 1MHz	—	720	—	pF
C <sub>oss</sub>	Output capacitance		—	150	—	pF
C <sub>rss</sub>	Reverse transfer capacitance		—	30	—	pF
t <sub>d</sub> (on)	Turn-on delay time	V <sub>DD</sub> = 150V, I <sub>D</sub> = 6A, V <sub>GS</sub> = 10V, R <sub>GEN</sub> = R <sub>GS</sub> = 50Ω	—	18	—	ns
t <sub>r</sub>	Rise time		—	35	—	ns
t <sub>d</sub> (off)	Turn-off delay time		—	80	—	ns
t <sub>f</sub>	Fall time		—	40	—	ns
V <sub>SD</sub>	Source-drain voltage	I <sub>S</sub> = 6A, V <sub>GS</sub> = 0V	—	1.5	2.0	V
R <sub>th</sub> (ch-c)	Thermal resistance	Channel to case	—	—	1.25	°C/W

**PERFORMANCE CURVES**

**POWER DISSIPATION DERATING CURVE**

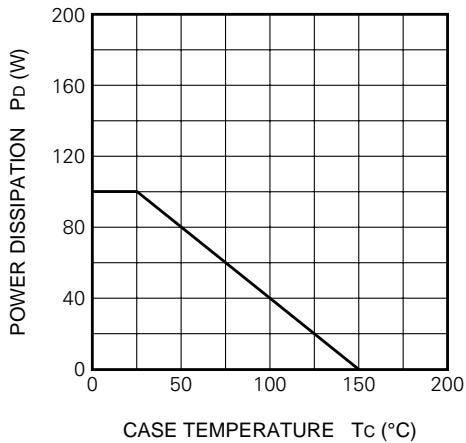

**MAXIMUM SAFE OPERATING AREA**

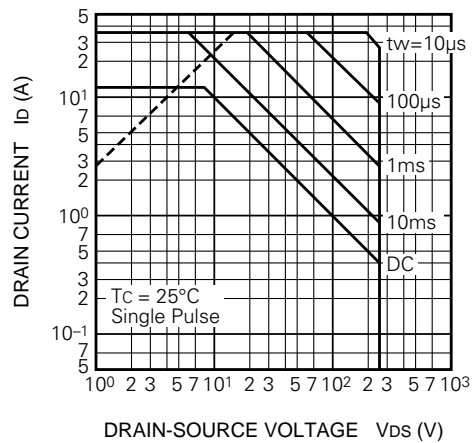

**OUTPUT CHARACTERISTICS (TYPICAL)**

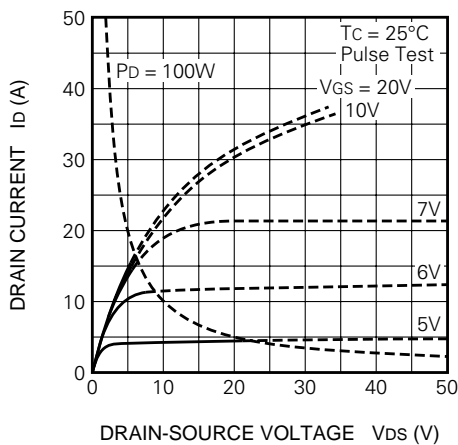

**OUTPUT CHARACTERISTICS (TYPICAL)**

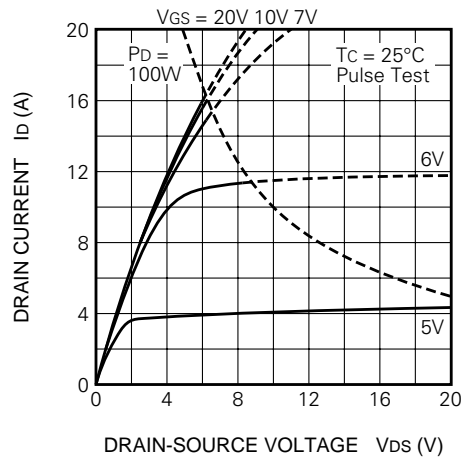

ON-STATE VOLTAGE VS. GATE-SOURCE VOLTAGE (TYPICAL)

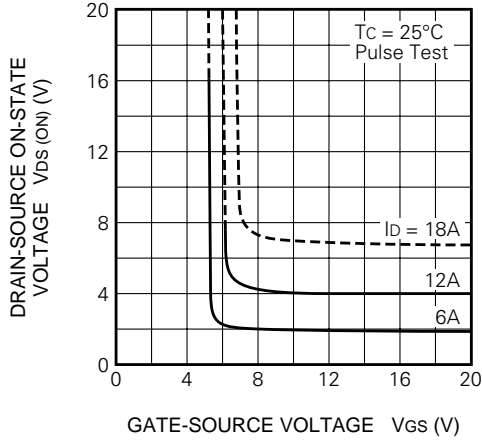

ON-STATE RESISTANCE VS. DRAIN CURRENT (TYPICAL)

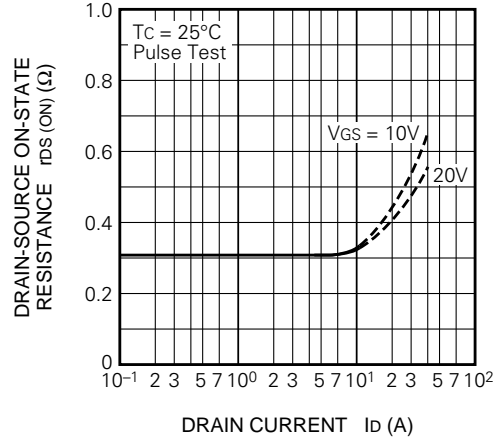

TRANSFER CHARACTERISTICS (TYPICAL)

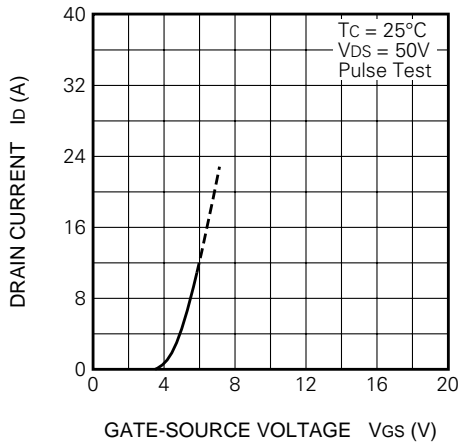

FORWARD TRANSFER ADMITTANCE VS. DRAIN CURRENT (TYPICAL)

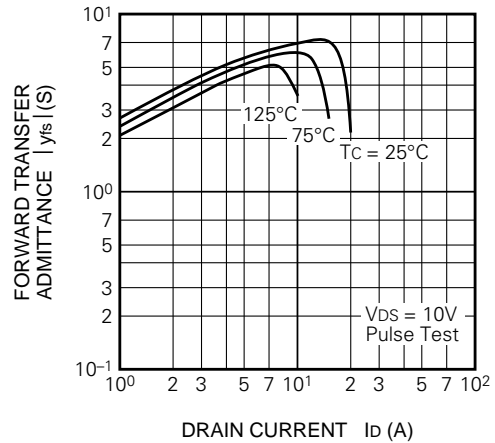

CAPACITANCE VS. DRAIN-SOURCE VOLTAGE (TYPICAL)

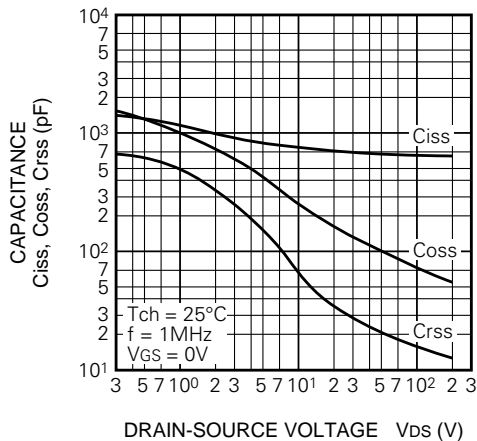

SWITCHING CHARACTERISTICS (TYPICAL)

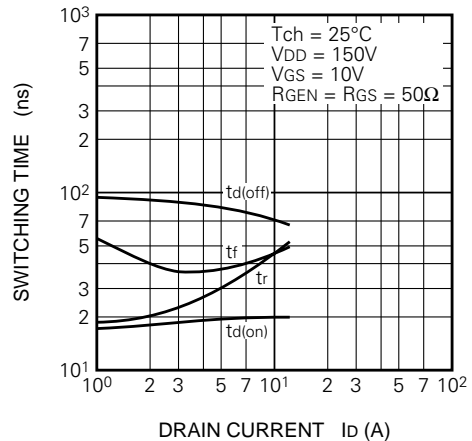

**GATE-SOURCE VOLTAGE VS. GATE CHARGE (TYPICAL)**

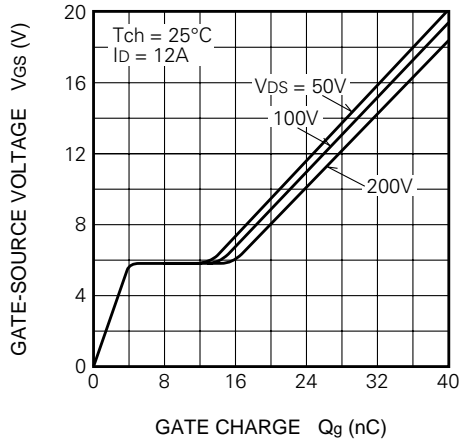

**SOURCE-DRAIN DIODE FORWARD CHARACTERISTICS (TYPICAL)**

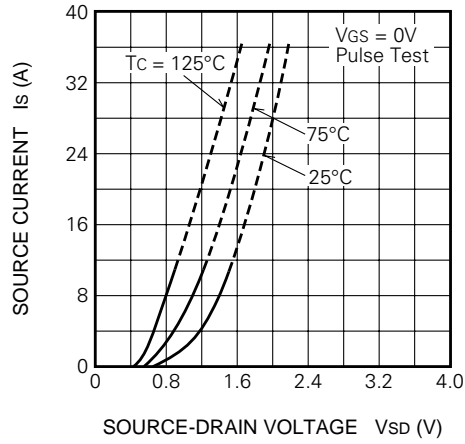

**ON-STATE RESISTANCE VS. CHANNEL TEMPERATURE (TYPICAL)**

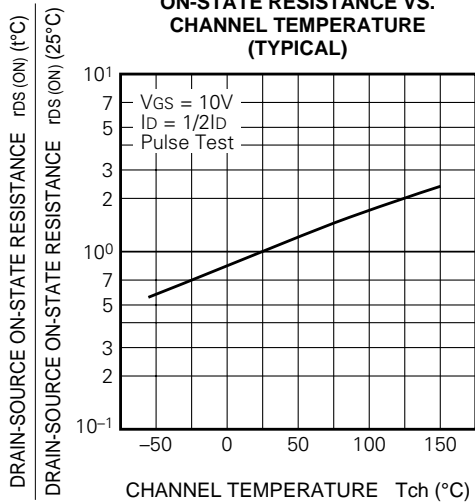

**THRESHOLD VOLTAGE VS. CHANNEL TEMPERATURE (TYPICAL)**

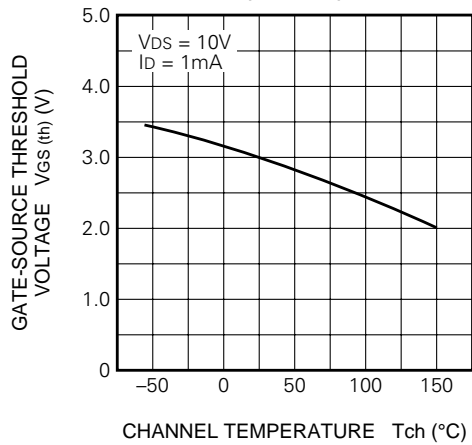

**BREAKDOWN VOLTAGE VS. CHANNEL TEMPERATURE (TYPICAL)**

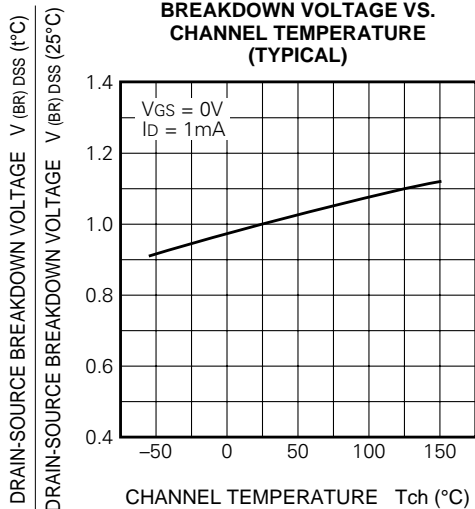

**TRANSIENT THERMAL IMPEDANCE CHARACTERISTICS**

