

# FK10KM-9

HIGH-SPEED SWITCHING USE

## FK10KM-9



- $V_{DSS}$  ..... 450V
- $r_{DS(ON)}$  (MAX) .....  $0.92\Omega$
- $I_D$  ..... 10A
- $V_{iso}$  ..... 2000V
- Integrated Fast Recovery Diode (MAX.) ..... 150ns

## OUTLINE DRAWING

Dimensions in mm

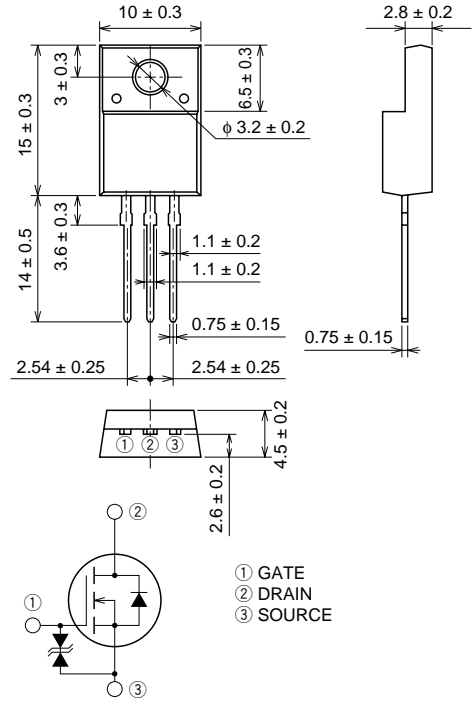

TO-220FN

## APPLICATION

Servo motor drive, Robot, UPS, Inverter Fluorecent lamp, etc.

## MAXIMUM RATINGS (Tc = 25°C)

Symbol	Parameter	Conditions	Ratings	Unit
$V_{DSS}$	Drain-source voltage	$V_{GS} = 0V$	450	V
$V_{GSS}$	Gate-source voltage	$V_{DS} = 0V$	$\pm 30$	V
$I_D$	Drain current		10	A
$I_{DM}$	Drain current (Pulsed)		30	A
$I_S$	Source current		10	A
$I_{SM}$	Source current (Pulsed)		30	A
$P_D$	Maximum power dissipation		35	W
$T_{ch}$	Channel temperature		-55 ~ +150	°C
$T_{stg}$	Storage temperature		-55 ~ +150	°C
$V_{iso}$	Isolation voltage	AC for 1minute, Terminal to case	2000	$V_{rms}$
—	Weight	Typical value	2.0	g

**ELECTRICAL CHARACTERISTICS** (T<sub>ch</sub> = 25°C)

Symbol	Parameter	Test conditions	Limits			Unit
			Min.	Typ.	Max.	
V (BR) DSS	Drain-source breakdown voltage	I <sub>D</sub> = 1mA, V <sub>GS</sub> = 0V	450	—	—	V
V (BR) GSS	Gate-source breakdown voltage	I <sub>G</sub> = ±100μA, V <sub>DS</sub> = 0V	±30	—	—	V
I <sub>GSS</sub>	Gate-source leakage current	V <sub>GS</sub> = ±25V, V <sub>DS</sub> = 0V	—	—	±10	μA
I <sub>DSS</sub>	Drain-source leakage current	V <sub>DS</sub> = 450V, V <sub>GS</sub> = 0V	—	—	1	mA
V <sub>GS</sub> (th)	Gate-source threshold voltage	I <sub>D</sub> = 1mA, V <sub>DS</sub> = 10V	2	3	4	V
r <sub>DS</sub> (ON)	Drain-source on-state resistance	I <sub>D</sub> = 5A, V <sub>GS</sub> = 10V	—	0.70	0.92	Ω
V <sub>DS</sub> (ON)	Drain-source on-state voltage	I <sub>D</sub> = 5A, V <sub>GS</sub> = 10V	—	3.50	4.60	V
y <sub>fs</sub>	Forward transfer admittance	I <sub>D</sub> = 5A, V <sub>DS</sub> = 10V	3.3	5.5	—	S
C <sub>iss</sub>	Input capacitance	V <sub>DS</sub> = 25V, V <sub>GS</sub> = 0V, f = 1MHz	—	1100	—	pF
C <sub>oss</sub>	Output capacitance		—	130	—	pF
C <sub>rss</sub>	Reverse transfer capacitance		—	20	—	pF
t <sub>d</sub> (on)	Turn-on delay time		—	20	—	ns
t <sub>r</sub>	Rise time	V <sub>DD</sub> = 200V, I <sub>D</sub> = 5A, V <sub>GS</sub> = 10V, R <sub>GEN</sub> = R <sub>GS</sub> = 50Ω	—	30	—	ns
t <sub>d</sub> (off)	Turn-off delay time		—	95	—	ns
t <sub>f</sub>	Fall time		—	35	—	ns
V <sub>SD</sub>	Source-drain voltage	I <sub>S</sub> = 5A, V <sub>GS</sub> = 0V	—	1.5	2.0	V
R <sub>th</sub> (ch-c)	Thermal resistance	Channel to case	—	—	3.57	°C/W
t <sub>rr</sub>	Reverse recovery time	I <sub>S</sub> = 10A, di <sub>s</sub> /dt = -100A/μs	—	—	150	ns

**PERFORMANCE CURVES**

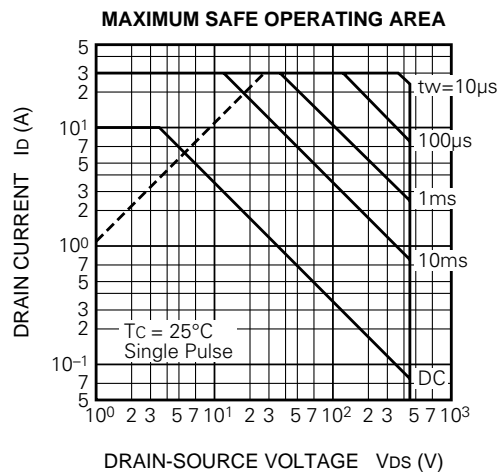
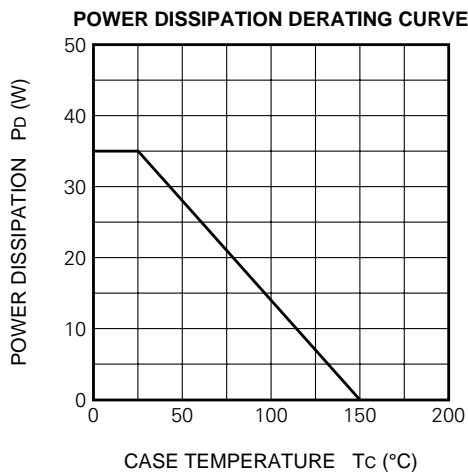

OUTPUT CHARACTERISTICS (TYPICAL)

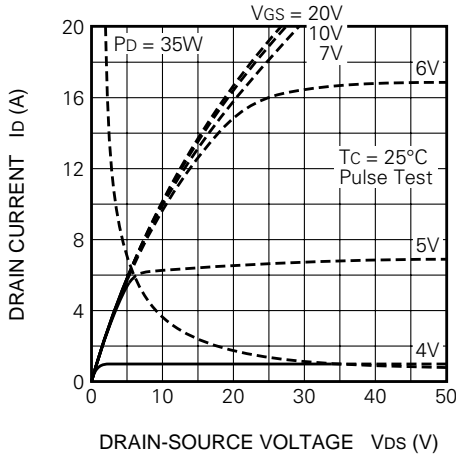

OUTPUT CHARACTERISTICS (TYPICAL)

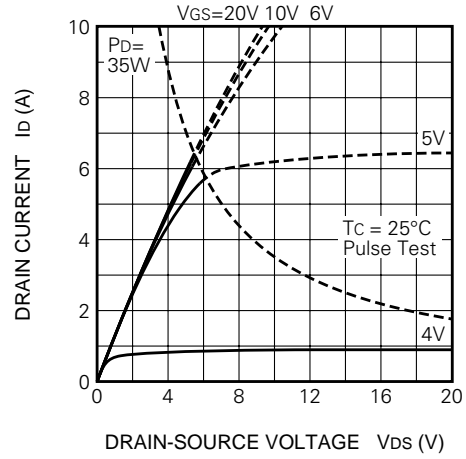

ON-STATE VOLTAGE VS. GATE-SOURCE VOLTAGE (TYPICAL)

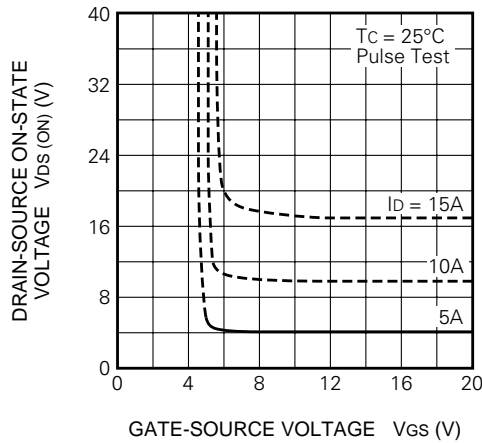

ON-STATE RESISTANCE VS. DRAIN CURRENT (TYPICAL)

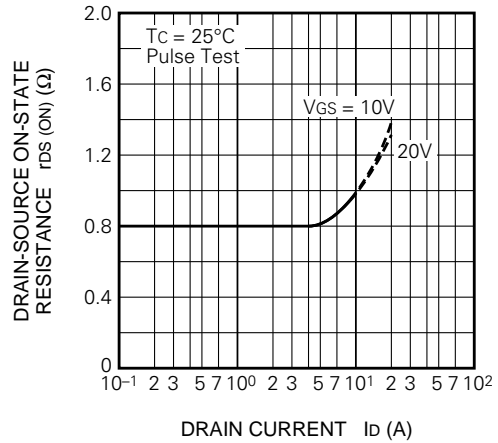

TRANSFER CHARACTERISTICS (TYPICAL)

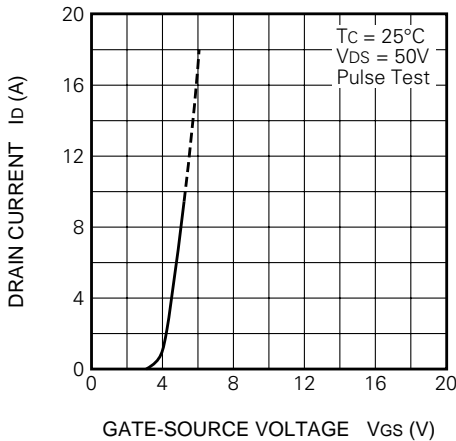

FORWARD TRANSFER ADMITTANCE VS. DRAIN CURRENT (TYPICAL)

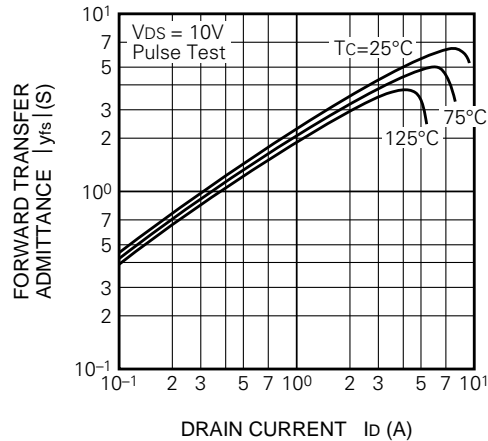

**CAPACITANCE VS. DRAIN-SOURCE VOLTAGE (TYPICAL)**

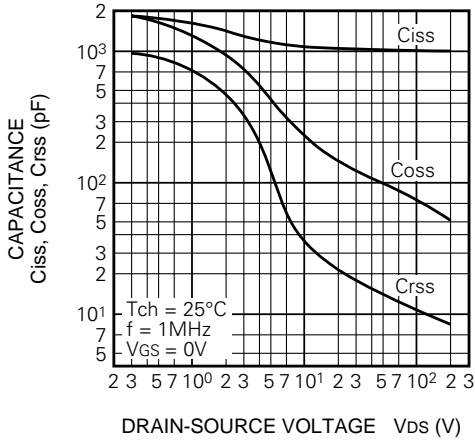

**SWITCHING CHARACTERISTICS (TYPICAL)**

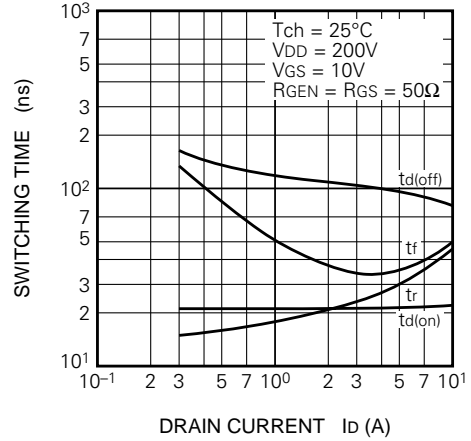

**GATE-SOURCE VOLTAGE VS. GATE CHARGE (TYPICAL)**

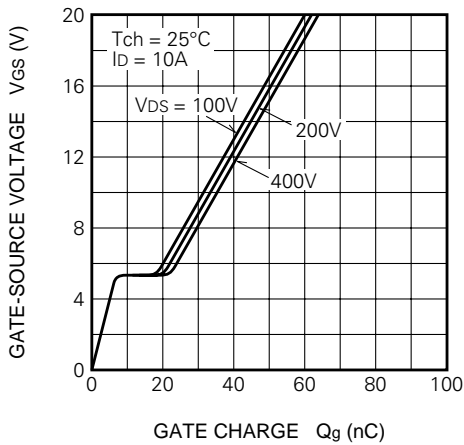

**SOURCE-DRAIN DIODE FORWARD CHARACTERISTICS (TYPICAL)**

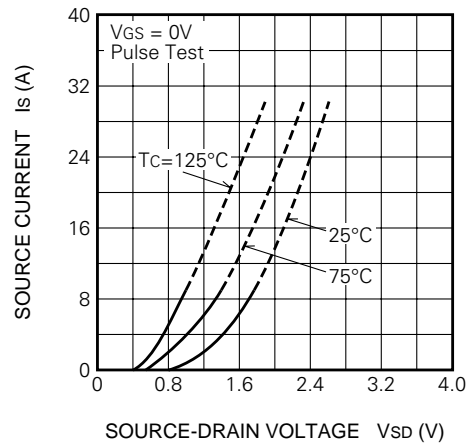

**ON-STATE RESISTANCE VS. CHANNEL TEMPERATURE (TYPICAL)**

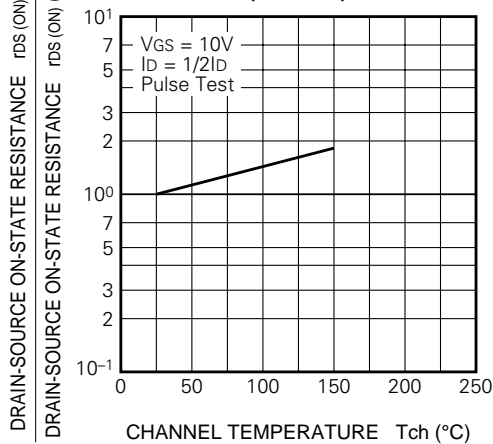

**THRESHOLD VOLTAGE VS. CHANNEL TEMPERATURE (TYPICAL)**

