

# CT75AM-12

GENERAL INVERTER • UPS USE

## CT75AM-12

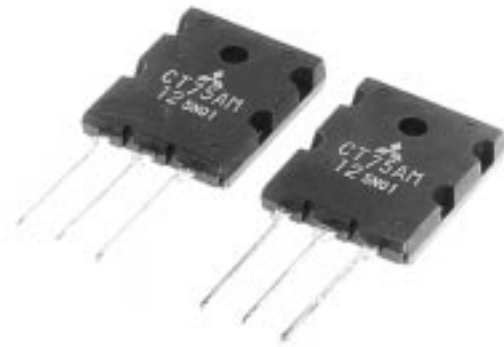

- VCES ..... 600V
- IC ..... 75A
- High Speed Switching
- Low VCE Saturation Voltage

## OUTLINE DRAWING

Dimensions in mm

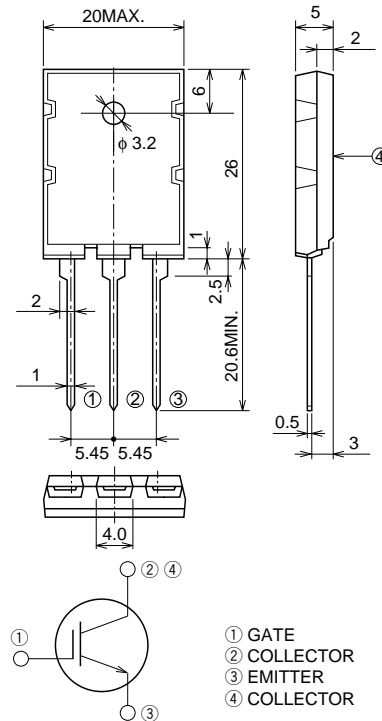

TO-3PL

## APPLICATION

AC & DC motor controls, General purpose inverters, UPS, Power supply switching, Servo controls, etc.

## MAXIMUM RATINGS (Tc = 25°C)

Symbol	Parameter	Conditions	Ratings	Unit
V <sub>CE</sub> S	Collector-emitter voltage	V <sub>GE</sub> = 0V	600	V
V <sub>GES</sub>	Gate-emitter voltage	V <sub>CE</sub> = 0V	±20	V
V <sub>GEM</sub>	Peak gate-emitter voltage	V <sub>CE</sub> = 0V	±30	V
I <sub>C</sub>	Collector current		75	A
I <sub>CM</sub>	Collector current (Pulsed)		150	A
P <sub>C</sub>	Maximum power dissipation		300	W
T <sub>j</sub>	Junction temperature		-40 ~ +150	°C
T <sub>stg</sub>	Storage temperature		-40 ~ +150	°C
—	Weight	Typical value	9.8	g

**ELECTRICAL CHARACTERISTICS** ( $T_j = 25^\circ\text{C}$ )

Symbol	Parameter	Test conditions	Limits			Unit
			Min.	Typ.	Max.	
V (BR) CES	Collector-emitter breakdown voltage	$I_C = 1\text{mA}, V_{GE} = 0\text{V}$	600	—	—	V
I GES	Collector-emitter leakage current	$V_{GE} = \pm 30\text{V}, V_{CE} = 0\text{V}$	—	—	$\pm 0.5$	$\mu\text{A}$
I CES	Gate-emitter leakage current	$V_{CE} = 600\text{V}, V_{GE} = 0\text{V}$	—	—	1	mA
V <sub>GE(th)</sub>	Gate-emitter threshold voltage	$I_C = 7.5\text{mA}, V_{CE} = 10\text{V}$	4.5	6.0	7.5	V
V <sub>CE(sat)</sub>	Collector-emitter saturation voltage	$I_C = 75\text{A}, V_{GE} = 15\text{V}$	—	2.5	3.0	V
C <sub>ies</sub>	Input capacitance	$V_{CE} = 25\text{V}, V_{GE} = 0\text{V}, f = 1\text{MHz}$	—	3100	—	pF
C <sub>oes</sub>	Output capacitance		—	400	—	pF
C <sub>res</sub>	Reverse transfer capacitance		—	130	—	pF
t <sub>d (on)</sub>	Turn-on delay time	$V_{CC} = 300\text{V}, \text{Resistance load}, I_C = 75\text{A}, V_{GE} = 15\text{V}, R_{GE} = 10\Omega$	—	40	—	ns
t <sub>r</sub>	Rise time		—	265	—	ns
t <sub>d (off)</sub>	Turn-off delay time		—	175	—	ns
t <sub>f</sub>	Fall time		—	245	—	ns
R <sub>th (j-c)</sub>	Thermal resistance	Junction to case	—	—	0.42	$^\circ\text{C/W}$

**PERFORMANCE CURVES**

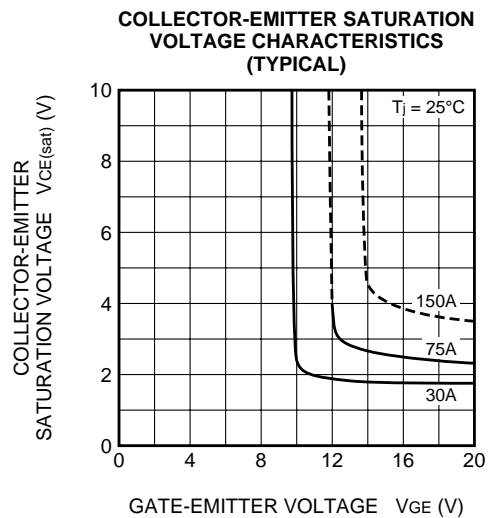
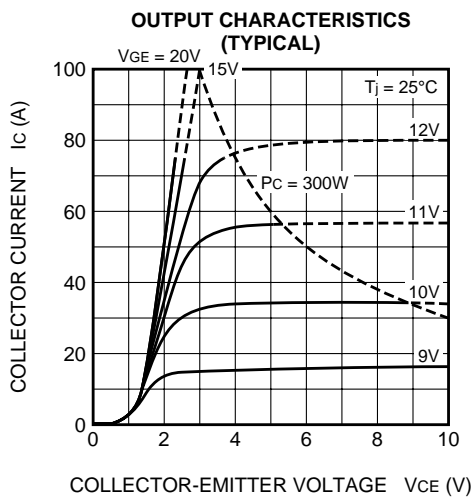

COLLECTOR-EMITTER SATURATION VOLTAGE CHARACTERISTICS (TYPICAL)

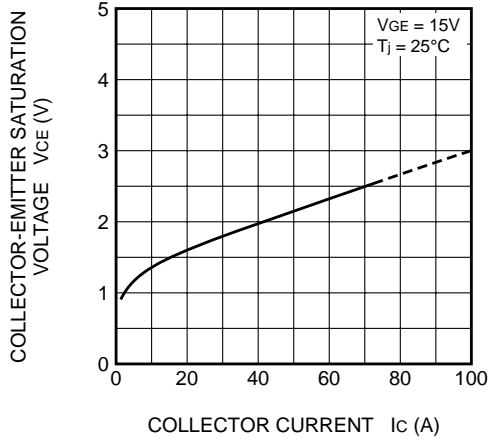

COLLECTOR CURRENT VS. GATE-EMITTER VOLTAGE CHARACTERISTIC (TYPICAL)

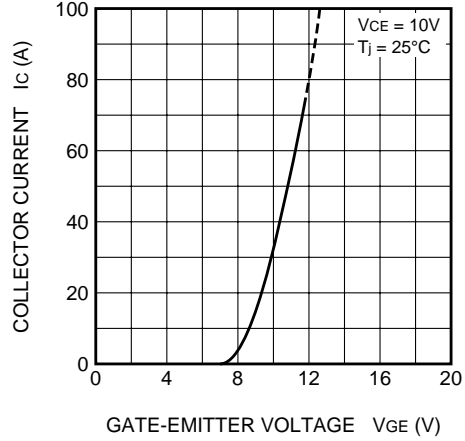

CAPACITANCE VS. COLLECTOR-EMITTER VOLTAGE CHARACTERISTIC (TYPICAL)

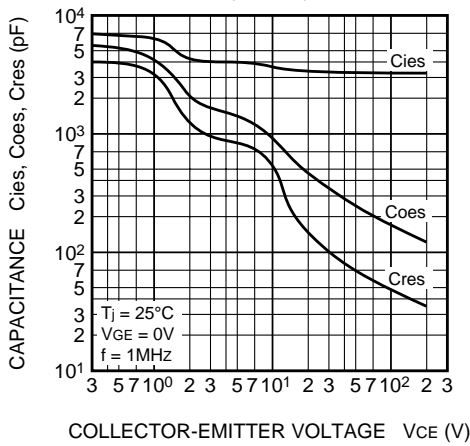

SWITCHING TIME-COLLECTOR CURRENT CHARACTERISTIC (TYPICAL)

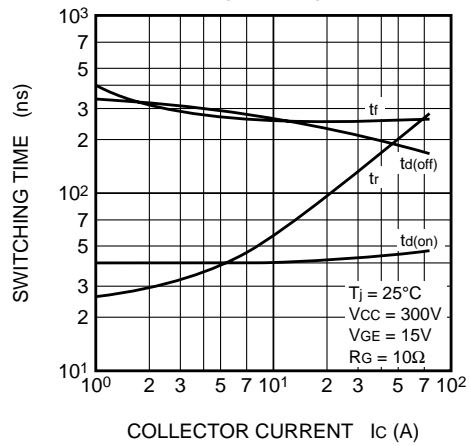

GATE-EMITTER VOLTAGE VS. GATE CHARGE CHARACTERISTIC (TYPICAL)

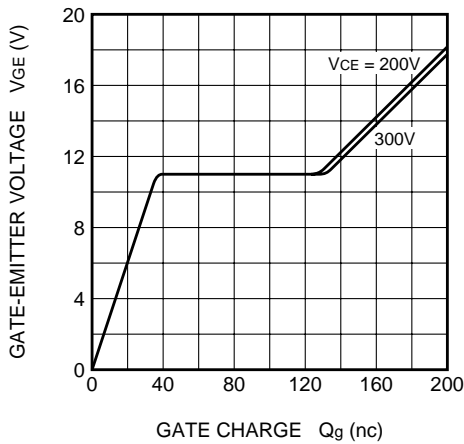

TRANSIENT THERMAL IMPEDANCE CHARACTERISTICS (TYPICAL)

