

**PRELIMINARY**  
 Notice: This is not a final specification.  
 Some parametric limits are subject to change.

MITSUBISHI Pch POWER MOSFET

# FX50SMJ-06

HIGH-SPEED SWITCHING USE

**FX50SMJ-06**

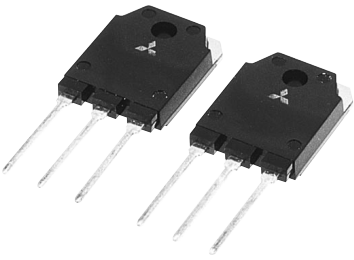

- 4V DRIVE
- $V_{DSS}$  ..... -60V
- $r_{DS(ON)}$  (MAX) ..... 18.9m $\Omega$
- $I_D$  ..... -50A
- Integrated Fast Recovery Diode (TYP.) ..... 70ns

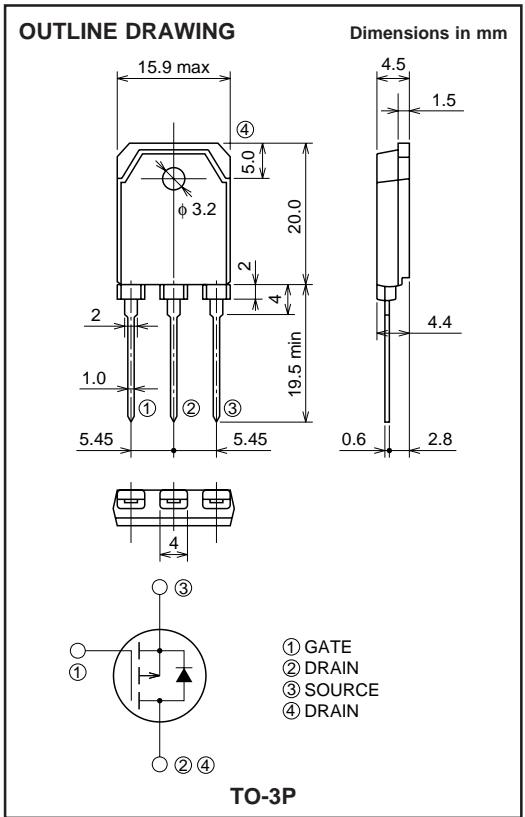

## APPLICATION

Motor control, Lamp control, Solenoid control  
 DC-DC converter, etc.

## MAXIMUM RATINGS (Tc = 25°C)

Symbol	Parameter	Conditions	Ratings	Unit
$V_{DSS}$	Drain-source voltage	$V_{GS} = 0V$	-60	V
$V_{GSS}$	Gate-source voltage	$V_{DS} = 0V$	$\pm 20$	V
$I_D$	Drain current		-50	A
$I_{DM}$	Drain current (Pulsed)		-200	A
$I_{DA}$	Avalanche drain current (Pulsed)	$L = 50\mu H$	-50	A
$I_S$	Source current		-50	A
$I_{SM}$	Source current (Pulsed)		-200	A
$P_D$	Maximum power dissipation		150	W
$T_{ch}$	Channel temperature		-55 ~ +150	°C
$T_{stg}$	Storage temperature		-55 ~ +150	°C
—	Weight	Typical value	4.8	g

Jan.1999

**PRELIMINARY**  
 Notice: This is not a final specification.  
 Some parametric limits are subject to change.

**ELECTRICAL CHARACTERISTICS** (Tch = 25°C)

Symbol	Parameter	Test conditions	Limits			Unit
			Min.	Typ.	Max.	
V (BR) DSS	Drain-source breakdown voltage	ID = -1mA, VGS = 0V	-60	—	—	V
IGSS	Gate-source leakage current	VGS = ±20V, VDS = 0V	—	—	±0.1	μA
IDSS	Drain-source leakage current	VDS = -60V, VGS = 0V	—	—	-0.1	mA
VGS (th)	Gate-source threshold voltage	ID = -1mA, VDS = -10V	-1.3	-1.8	-2.3	V
rDS (ON)	Drain-source on-state resistance	ID = -25A, VGS = -10V	—	15.0	18.9	mΩ
rDS (ON)	Drain-source on-state resistance	ID = -25A, VGS = -4V	—	23	32	mΩ
VDS (ON)	Drain-source on-state voltage	ID = -25A, VGS = -10V	—	-0.38	-0.47	V
yfs	Forward transfer admittance	ID = -25A, VDS = -10V	—	49.1	—	S
Ciss	Input capacitance	VDS = -10V, VGS = 0V, f = 1MHz	—	11610	—	pF
Coss	Output capacitance		—	1355	—	pF
Crss	Reverse transfer capacitance		—	687	—	pF
td (on)	Turn-on delay time		—	73	—	ns
tr	Rise time	VDD = -30V, ID = -25A, VGS = -10V, RGEN = RGS = 50Ω	—	137	—	ns
td (off)	Turn-off delay time		—	822	—	ns
tf	Fall time		—	320	—	ns
VSD	Source-drain voltage	IS = -25A, VGS = 0V	—	-1.0	-1.5	V
Rth (ch-c)	Thermal resistance	Channel to case	—	—	0.83	°C/W
trr	Reverse recovery time	IS = -50A, dis/dt = 100A/μs	—	70	—	ns

**PERFORMANCE CURVES**

**POWER DISSIPATION DERATING CURVE**

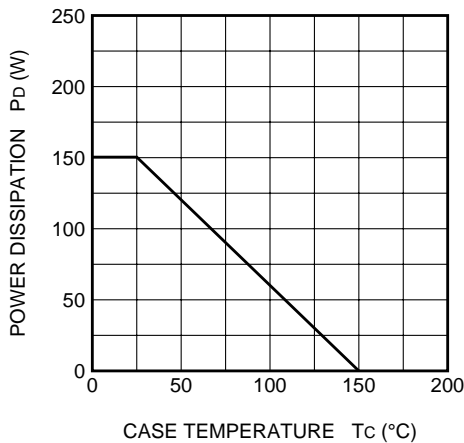

**MAXIMUM SAFE OPERATING AREA**

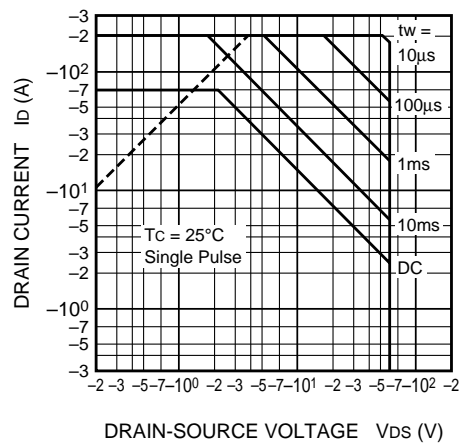

**OUTPUT CHARACTERISTICS (TYPICAL)**

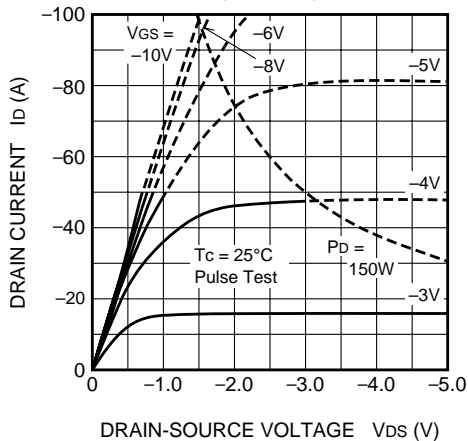

**OUTPUT CHARACTERISTICS (TYPICAL)**

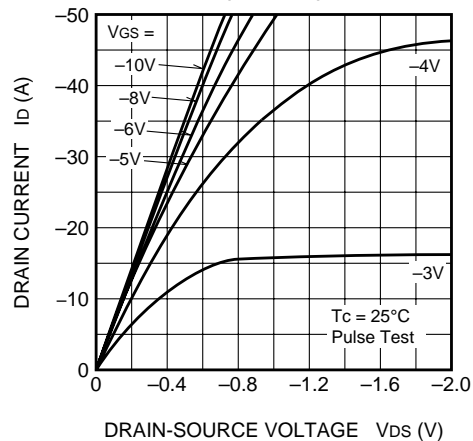

**PRELIMINARY**  
 Notice: This is not a final specification.  
 Some parametric limits are subject to change.

**ON-STATE VOLTAGE VS. GATE-SOURCE VOLTAGE (TYPICAL)**

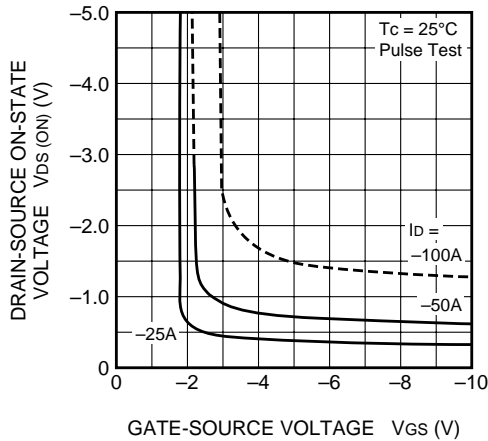

**ON-STATE RESISTANCE VS. DRAIN CURRENT (TYPICAL)**

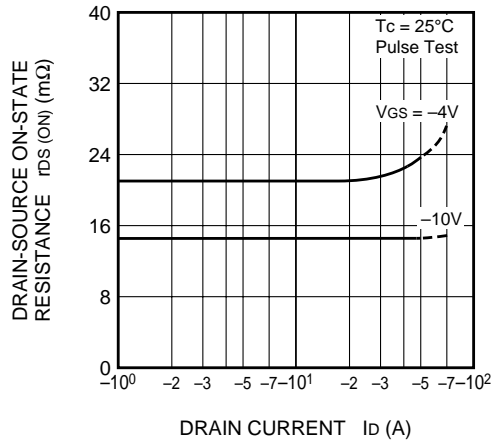

**TRANSFER CHARACTERISTICS (TYPICAL)**

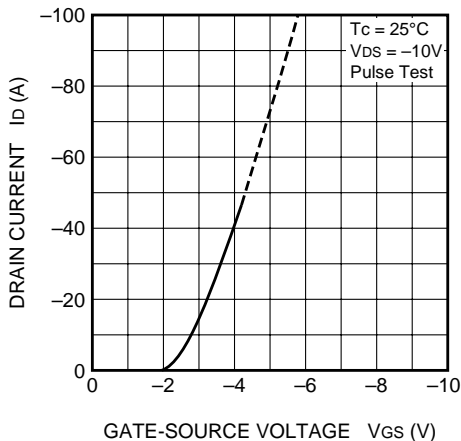

**FORWARD TRANSFER ADMITTANCE VS. DRAIN CURRENT (TYPICAL)**

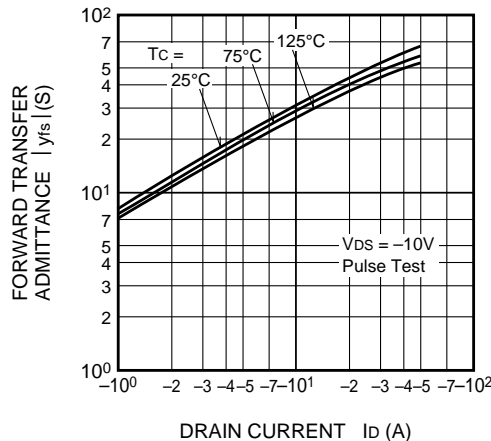

**CAPACITANCE VS. DRAIN-SOURCE VOLTAGE (TYPICAL)**

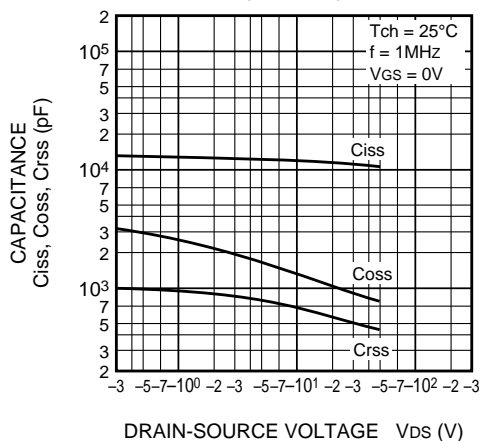

**SWITCHING CHARACTERISTICS (TYPICAL)**

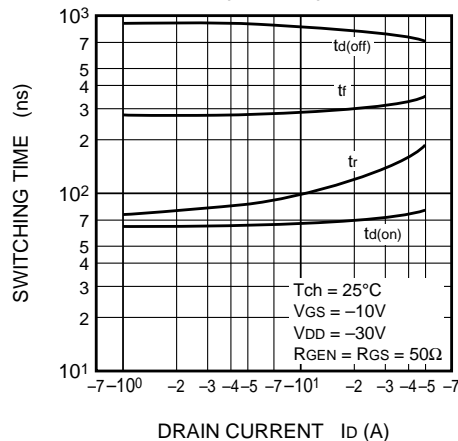

**PRELIMINARY**  
 Notice: This is not a final specification.  
 Some parametric limits are subject to change.

**GATE-SOURCE VOLTAGE VS. GATE CHARGE (TYPICAL)**

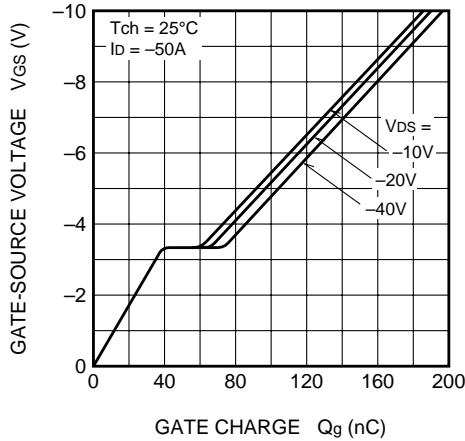

**SOURCE-DRAIN DIODE FORWARD CHARACTERISTICS (TYPICAL)**

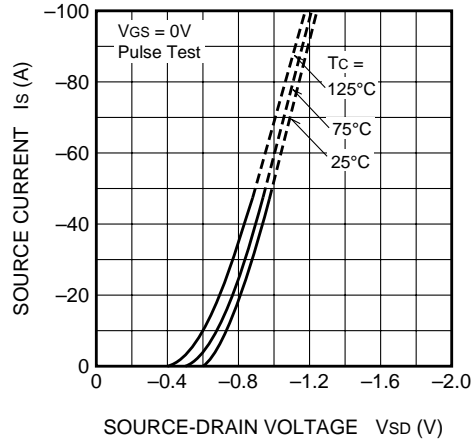

**ON-STATE RESISTANCE VS. CHANNEL TEMPERATURE (TYPICAL)**

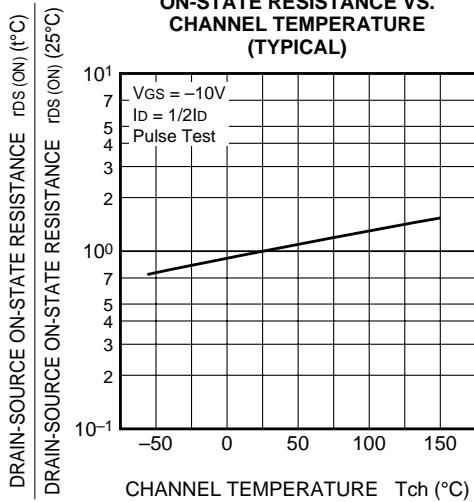

**THRESHOLD VOLTAGE VS. CHANNEL TEMPERATURE (TYPICAL)**

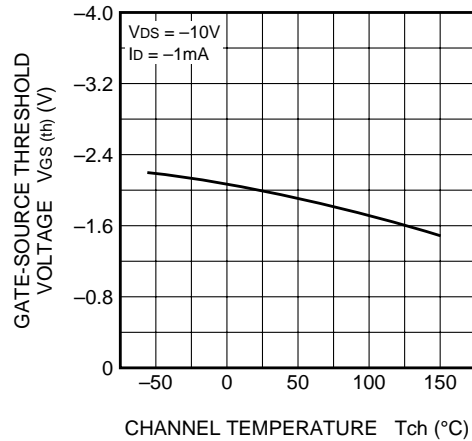

**BREAKDOWN VOLTAGE VS. CHANNEL TEMPERATURE (TYPICAL)**

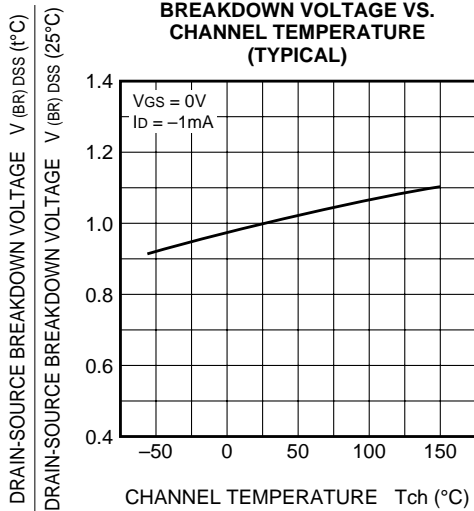

**TRANSIENT THERMAL IMPEDANCE CHARACTERISTICS**

