

# BCR08AS-8

LOW POWER USE  
NON-INSULATED TYPE, PLANAR PASSIVATION TYPE

**BCR08AS-8**



- **IT (RMS)** ..... **0.8A**
- **VDRM** ..... **400V**
- **IFGT I , IRGT I , IRGT III** ..... **5mA**
- **IFGT III** ..... **10mA**

**OUTLINE DRAWING** Dimensions  
in mm

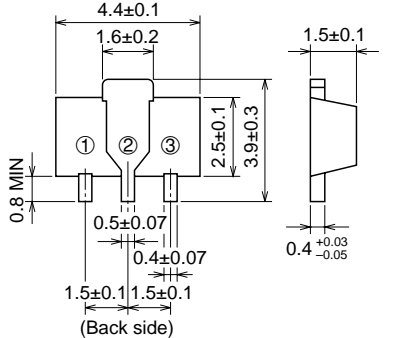

(Back side)

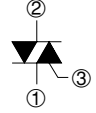

① T1 TERMINAL  
② T2 TERMINAL  
③ GATE TERMINAL

SOT-89

## APPLICATION

Hybrid IC, solid state relay,  
control of household equipment such as electric fan · washing machine,  
other general purpose control applications

## MAXIMUM RATINGS

Symbol	Parameter	Voltage class	
		8 (marked "B*")	
			Unit
VDRM	Repetitive peak off-state voltage*1	400	V
VDSM	Non-repetitive peak off-state voltage*1	500	V

Symbol	Parameter	Conditions	Ratings	Unit
IT (RMS)	RMS on-state current	Commercial frequency, sine full wave 360° conduction, Ta=40°C*4	0.8	A
ITSM	Surge on-state current	60Hz sinewave 1 full cycle, peak value, non-repetitive	8	A
I <sup>2</sup> t	I <sup>2</sup> t for fusing	Value corresponding to 1 cycle of half wave 60Hz, surge on-state current	0.26	A <sup>2</sup> s
PGM	Peak gate power dissipation		1	W
PG (AV)	Average gate power dissipation		0.1	W
VGM	Peak gate voltage		6	V
IGM	Peak gate current		1	A
Tj	Junction temperature		-40 ~ +125	°C
Tstg	Storage temperature		-40 ~ +125	°C
—	Weight	Typical value	48	mg

\*1. Gate open.

# BCR08AS-8

LOW POWER USE  
NON-INSULATED TYPE, PLANAR PASSIVATION TYPE

## ELECTRICAL CHARACTERISTICS

Symbol	Parameter	Test conditions	Limits			Unit	
			Min.	Typ.	Max.		
IDRM	Repetitive peak off-state current	$T_j=125^\circ\text{C}$ , $V_{\text{DRM}}$ applied	—	—	1.0	mA	
VTM	On-state voltage	$T_c=25^\circ\text{C}$ , $I_{\text{TM}}=1.2\text{A}$ , Instantaneous measurement	—	—	2.0	V	
VFGT I	Gate trigger voltage *2	$T_j=25^\circ\text{C}$ , $V_D=6\text{V}$ , $R_L=6\Omega$ , $R_G=330\Omega$	I	—	—	2.0	V
VRGT I			II	—	—	2.0	V
VRGT III			III	—	—	2.0	V
VFGT III			IV	—	—	2.0	V
IFGT I	Gate trigger current *2	$T_j=25^\circ\text{C}$ , $V_D=6\text{V}$ , $R_L=6\Omega$ , $R_G=330\Omega$	I	—	—	5	mA
IRGT I			II	—	—	5	mA
IRGT III			III	—	—	5	mA
IFGT III			IV	—	—	10	mA
VGD	Gate non-trigger voltage	$T_j=125^\circ\text{C}$ , $V_D=1/2V_{\text{DRM}}$	0.1	—	—	V	
$R_{\text{th}}(j-a)$	Thermal resistance	Junction to case *4	—	—	65	$^\circ\text{C}/\text{W}$	
$(dv/dt)_c$	Critical-rate of rise of off-state commutating voltage		*3	—	—	$\text{V}/\mu\text{s}$	

\*2. Measurement using the gate trigger characteristics measurement circuit.  
 \*3. The critical-rate of rise of the off-state commutating voltage is shown in the table below.  
 \*4. Mounted on 25mm × 25mm × 0.7mm ceramic plate with solder.

Voltage class	$V_{\text{DRM}}$ (V)	$(dv/dt)_c$		Test conditions	Commutating voltage and current waveforms (inductive load)
		Min.	Unit		
8	400	2	$\text{V}/\mu\text{s}$	1. Junction temperature $T_j=125^\circ\text{C}$ 2. Rate of decay of on-state commutating current $(di/dt)_c=0.4\text{A}/\text{ms}$ 3. Peak off-state voltage $V_D=400\text{V}$	

## PERFORMANCE CURVES

MAXIMUM ON-STATE CHARACTERISTICS

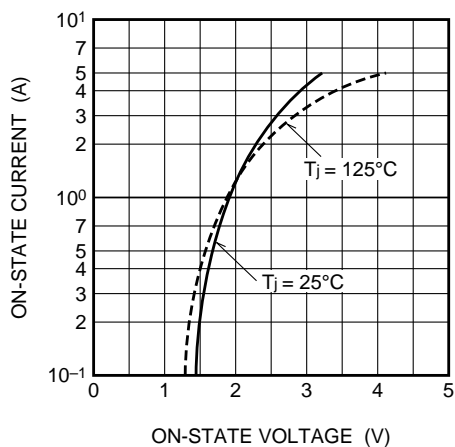

RATED SURGE ON-STATE CURRENT

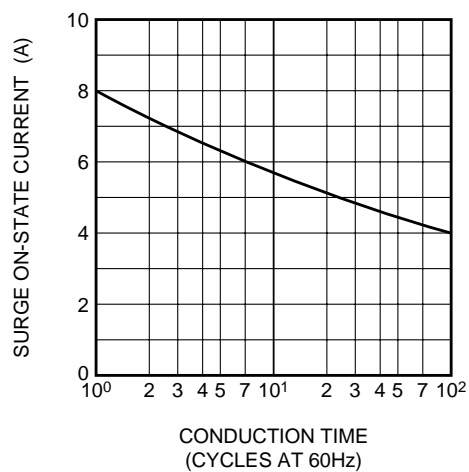

# BCR08AS-8

LOW POWER USE  
NON-INSULATED TYPE, PLANAR PASSIVATION TYPE

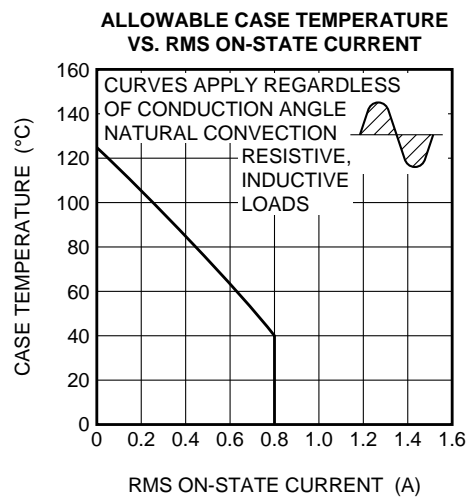
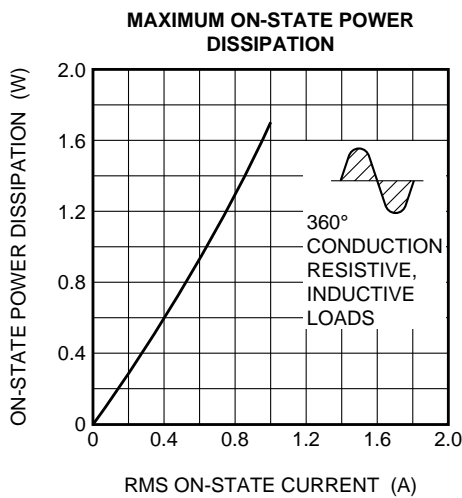
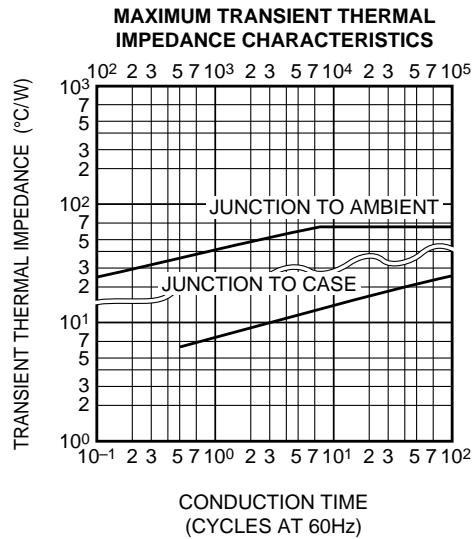
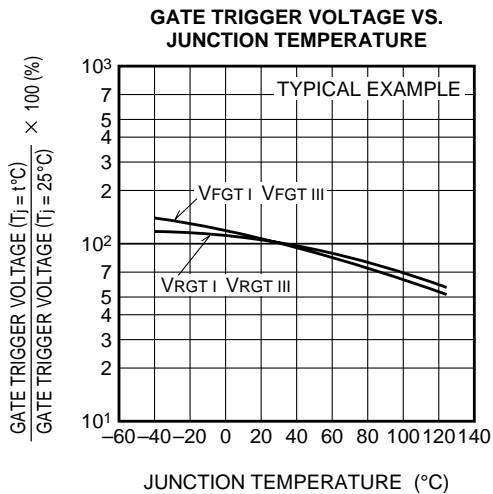
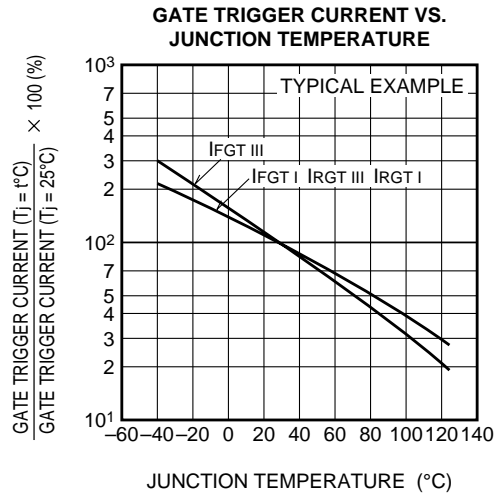
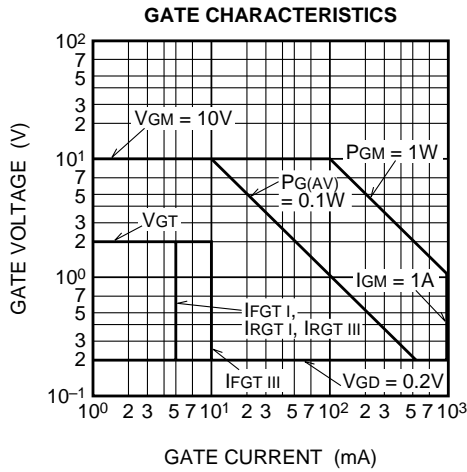

# BCR08AS-8

LOW POWER USE

NON-INSULATED TYPE, PLANAR PASSIVATION TYPE

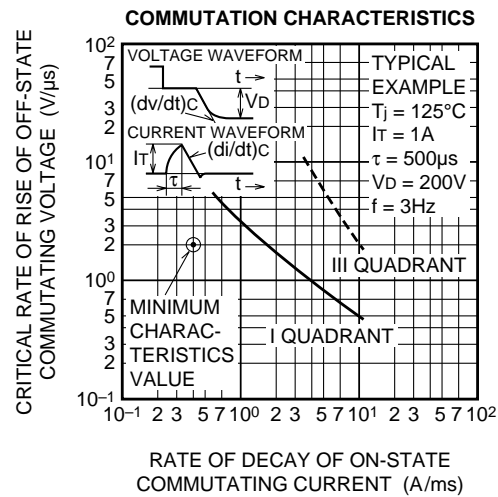
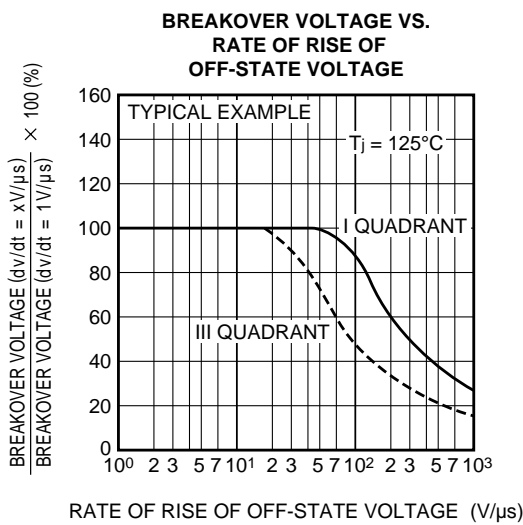
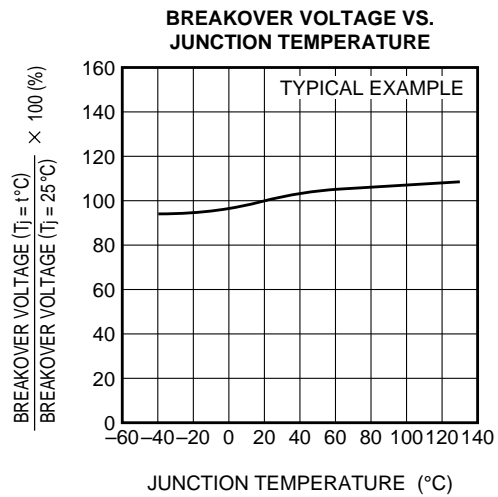
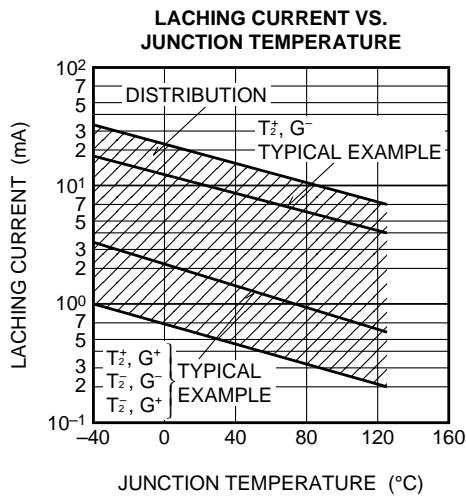
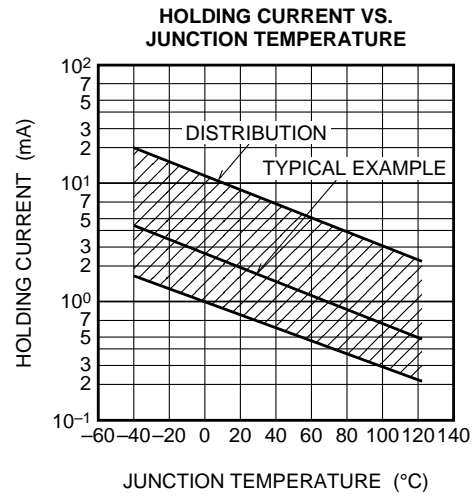
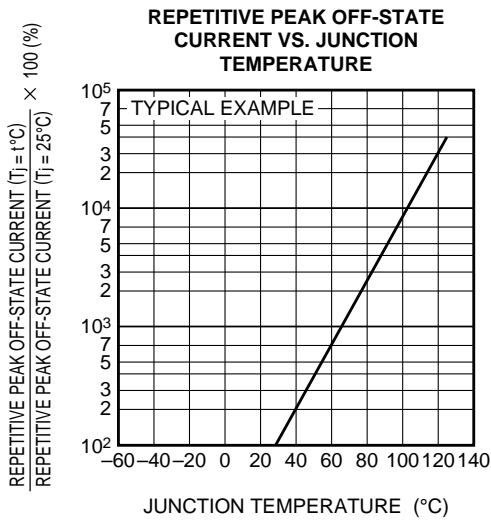

# BCR08AS-8

LOW POWER USE  
NON-INSULATED TYPE, PLANAR PASSIVATION TYPE

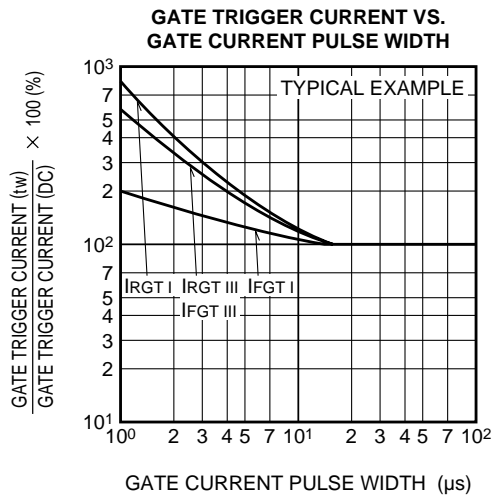

**GATE TRIGGER CHARACTERISTICS  
TEST CIRCUITS**

