

# CR6CM

MEDIUM POWER USE  
NON-INSULATED TYPE, GLASS PASSIVATION TYPE

**CR6CM**

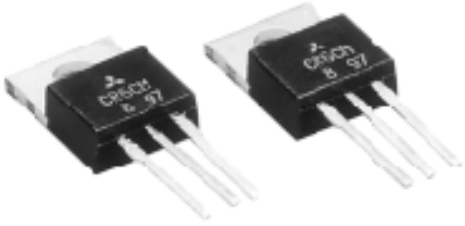

- $I_T$  (AV) ..... 6A
- $V_{DRM}$  ..... 400V/600V
- $I_{GT}$  ..... 10mA

**OUTLINE DRAWING**

Dimensions in mm

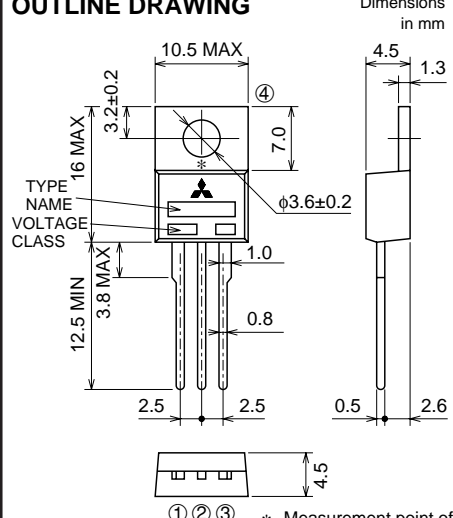

TYPE NAME  
VOLTAGE CLASS

\* Measurement point of case temperature

① CATHODE  
② ANODE  
③ GATE  
④ ANODE

TO-220

## APPLICATION

Switching mode power supply, ECR, regulator for auticycle, motor control

## MAXIMUM RATINGS

Symbol	Parameter	Voltage class		Unit
		8	12	
VRRM	Repetitive peak reverse voltage	400	600	V
VRSM	Non-repetitive peak reverse voltage	500	720	V
VR (DC)	DC reverse voltage	320	480	V
VDRM	Repetitive peak off-state voltage	400	600	V
Vd (DC)	DC off-state voltage	320	480	V

Symbol	Parameter	Conditions	Ratings	Unit
$I_T$ (RMS)	RMS on-state current		9.4	A
$I_T$ (AV)	Average on-state current	Commercial frequency, sine half wave, 180° conduction, $T_c=88^\circ\text{C}$	6	A
$I_{TSM}$	Surge on-state current	60Hz sine half wave 1 full cycle, peak value, non-repetitive	90	A
$I^2_t$	$I^2_t$ for fusing	Value corresponding to 1 cycle of half wave 60Hz, surge on-state current	34	A <sup>2</sup> s
PGM	Peak gate power dissipation		5	W
PG (AV)	Average gate power dissipation		0.5	W
VFGM	Peak gate forward voltage		6	V
VRGM	Peak gate reverse voltage		10	V
IFGM	Peak gate forward current		2	A
$T_j$	Junction temperature		-40 ~ +125	°C
$T_{stg}$	Storage temperature		-40 ~ +125	°C
—	Weight	Typical value	2.0	g

**ELECTRICAL CHARACTERISTICS**

Symbol	Parameter	Test conditions	Limits			Unit
			Min.	Typ.	Max.	
IRRM	Repetitive peak reverse current	$T_j=125^\circ\text{C}$ , $V_{RRM}$ applied	—	—	2.0	mA
IDRM	Repetitive peak off-state current	$T_j=125^\circ\text{C}$ , $V_{DRM}$ applied	—	—	2.0	mA
V <sub>TM</sub>	On-state voltage	$T_c=25^\circ\text{C}$ , $I_{TM}=20\text{A}$ , instantaneous value	—	—	1.7	V
V <sub>GT</sub>	Gate trigger voltage	$T_j=25^\circ\text{C}$ , $V_D=6\text{V}$ , $I_T=1\text{A}$	—	—	1.0	V
V <sub>GD</sub>	Gate non-trigger voltage	$T_j=125^\circ\text{C}$ , $V_D=1/2V_{DRM}$	0.2	—	—	V
I <sub>GT</sub>	Gate trigger current	$T_j=25^\circ\text{C}$ , $V_D=6\text{V}$ , $I_T=1\text{A}$	—	—	10	mA
I <sub>H</sub>	Holding current	$T_j=25^\circ\text{C}$ , $V_D=12\text{V}$	—	15	—	mA
R <sub>th(j-c)</sub>	Thermal resistance	Junction to case *1	—	—	3.0	$^\circ\text{C/W}$

\*1. The contact thermal resistance R<sub>th(j-c)</sub> is 1.0 $^\circ\text{C/W}$  with greased.

**PERFORMANCE CURVES**

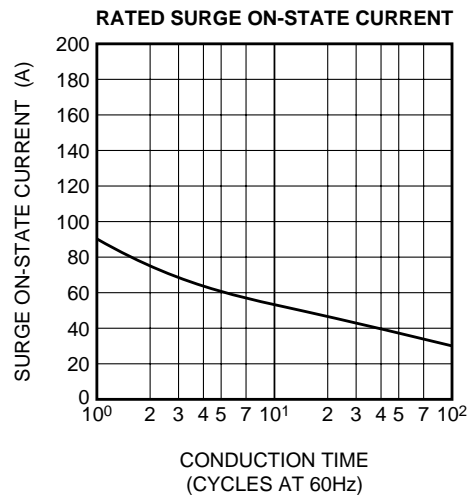
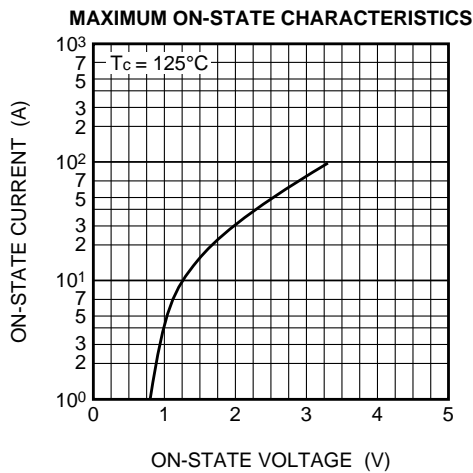

# CR6CM

MEDIUM POWER USE  
NON-INSULATED TYPE, GLASS PASSIVATION TYPE

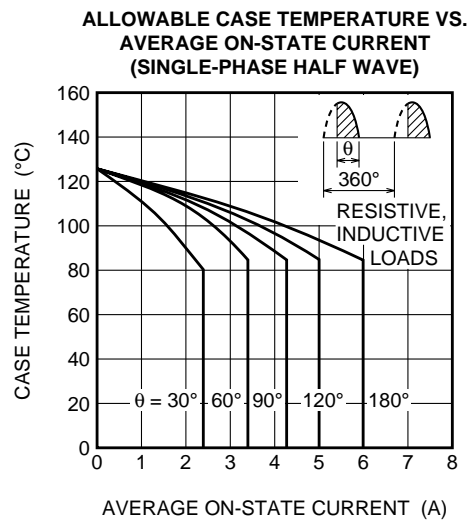
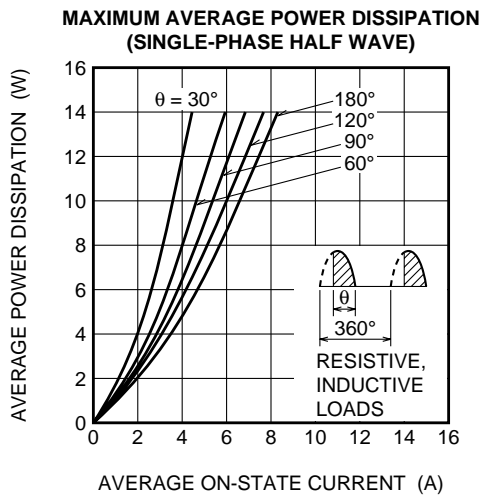
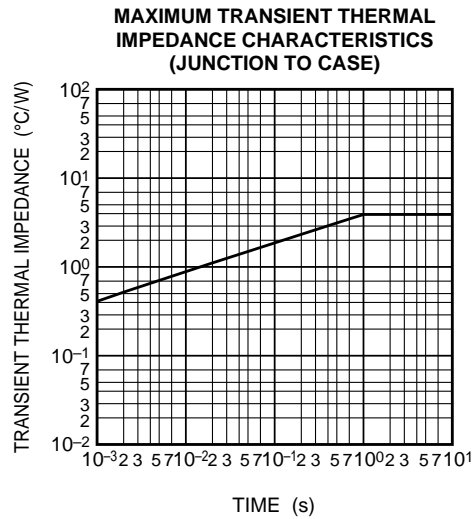
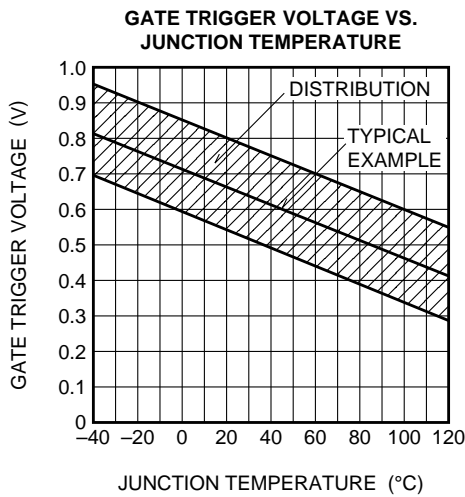
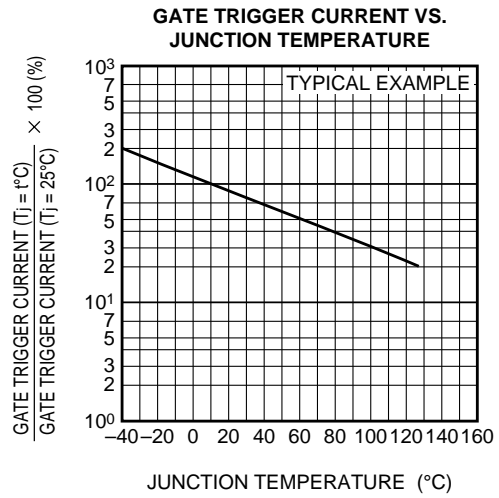
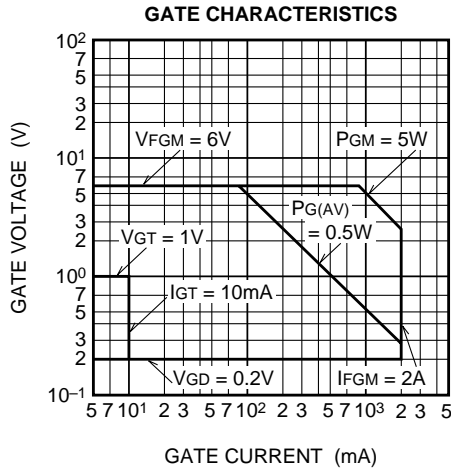

**CR6CM**

MEDIUM POWER USE

NON-INSULATED TYPE, GLASS PASSIVATION TYPE

**MAXIMUM AVERAGE POWER DISSIPATION  
(SINGLE-PHASE FULL WAVE)**

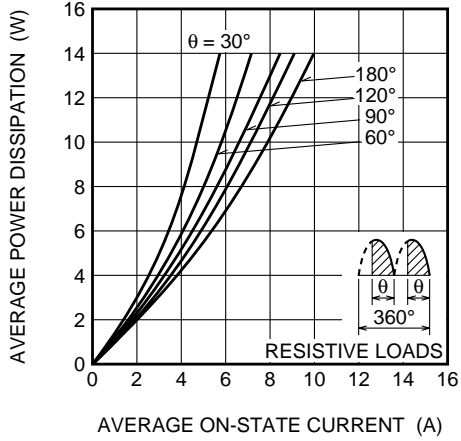

**ALLOWABLE CASE TEMPERATURE VS.  
AVERAGE ON-STATE CURRENT  
(SINGLE-PHASE FULL WAVE)**

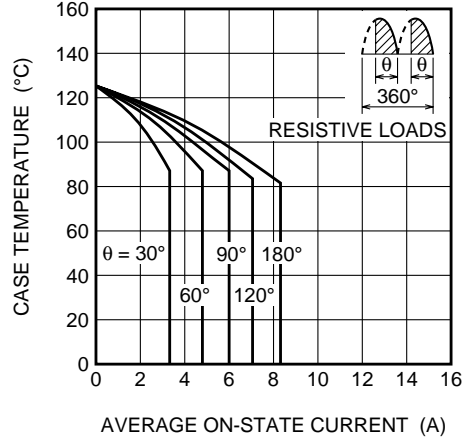

**MAXIMUM AVERAGE POWER DISSIPATION  
(RECTANGULAR WAVE)**

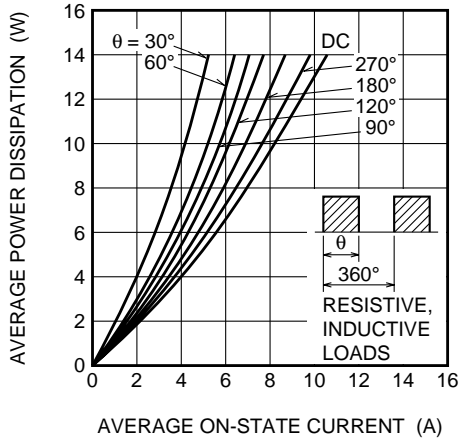

**ALLOWABLE AMBIENT TEMPERATURE VS.  
AVERAGE ON-STATE CURRENT  
(RECTANGULAR WAVE)**

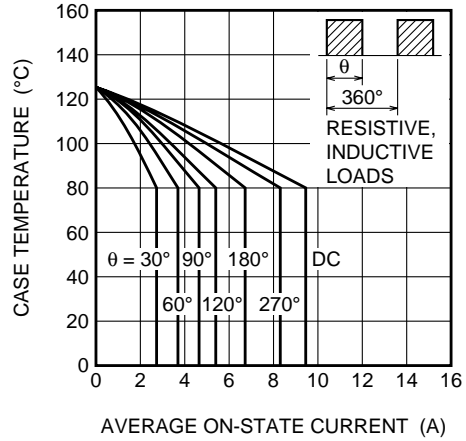

**BREAKOVER VOLTAGE VS.  
JUNCTION TEMPERATURE**

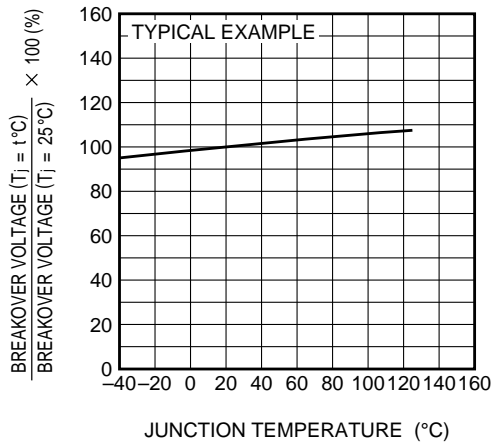

**BREAKOVER VOLTAGE VS.  
RATE OF RISE OF OFF-STATE VOLTAGE**

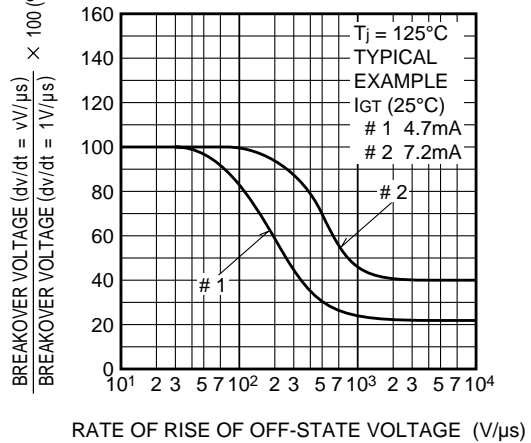

**CR6CM**

MEDIUM POWER USE

NON-INSULATED TYPE, GLASS PASSIVATION TYPE

**HOLDING CURRENT VS. JUNCTION TEMPERATURE**

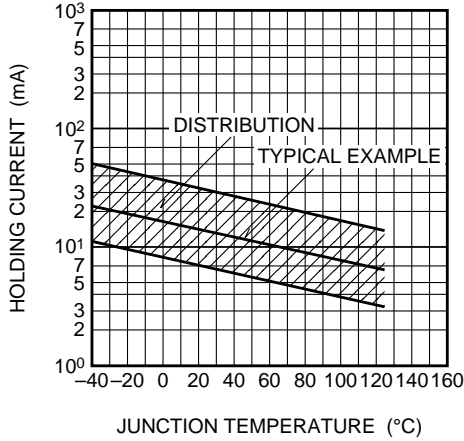

**HOLDING CURRENT VS. GATE TRIGGER CURRENT**

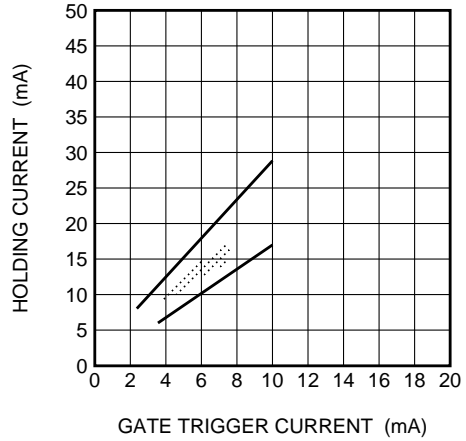

**TURN-ON TIME VS. GATE CURRENT**

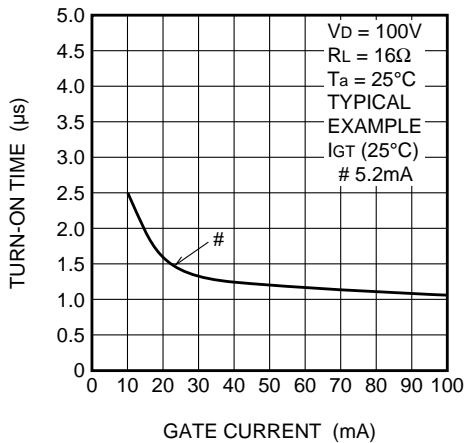

**TURN-OFF TIME VS. JUNCTION TEMPERATURE**

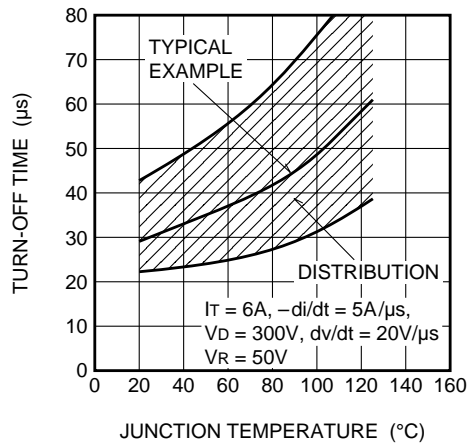

**REPETITIVE PEAK REVERSE VOLTAGE VS. JUNCTION TEMPERATURE**

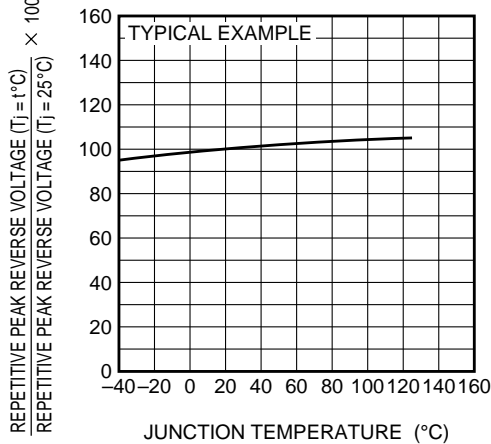

**GATE TRIGGER CURRENT VS. GATE CURRENT PULSE WIDTH**

