

# CR20F

MEDIUM POWER USE  
NON-INSULATED TYPE, GLASS PASSIVATION TYPE

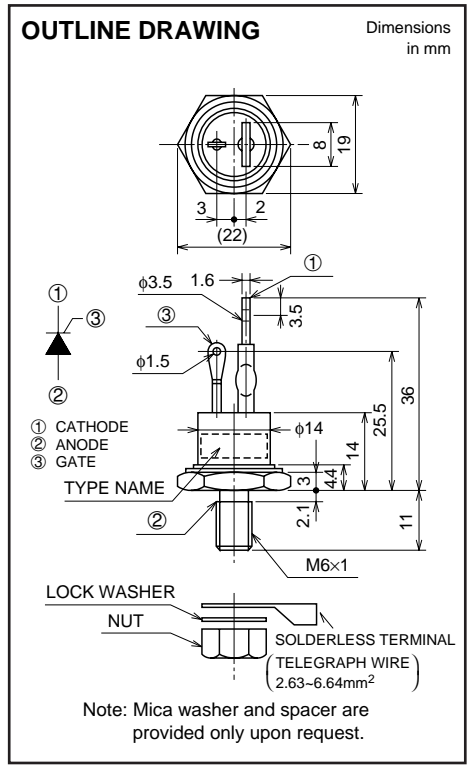

## APPLICATION

DC motor control, electric furnace control, static switches, DC supply

## MAXIMUM RATINGS

Symbol	Parameter	Voltage class					Unit
		8	12	16	20	24	
VRRM	Repetitive peak reverse voltage	400	600	800	1000	1200	V
VRSM	Non-repetitive peak reverse voltage	480	720	960	1200	1350	V
VR (DC)	DC reverse voltage	320	480	640	800	960	V
VDRM	Repetitive peak off-state voltage	400	600	800	1000	1200	V
VDSM	Non-repetitive peak off-state voltage	480	720	980	1000	1200	V
VD (DC)	DC off-state voltage	320	480	640	800	960	V

Symbol	Parameter	Conditions	Ratings	Unit
$I_T$ (RMS)	RMS on-state current		31.5	A
$I_T$ (AV)	Average on-state current	Commercial frequency, sine half wave, 180° conduction, $T_c=86^\circ\text{C}$	20	A
$I_{TSM}$	Surge on-state current	60Hz sine half wave 1 full cycle, peak value, non-repetitive	300	A
$I^2t$	$I^2t$ for fusing	Value corresponding to 1 cycle of half wave 60Hz, surge on-state current	380	A <sup>2</sup> s
di/dt	Critical rate of rise of on-state current	$V_D=1/2V_{DRM}$ , $I_{TM}=60\text{A}$ , $I_G=0.1\text{A}$ , $T_j=25^\circ\text{C}$ , $f=60\text{Hz}$	100	A/ $\mu\text{s}$
PGM	Peak gate power dissipation		5.0	W
PG (AV)	Average gate power dissipation		0.5	W
VFGM	Peak gate forward voltage		10	V
VRGM	Peak gate reverse voltage		5	V
IFGM	Peak gate forward current		2	A
$T_j$	Junction temperature		-30 ~ +125	$^\circ\text{C}$
$T_{stg}$	Storage temperature		-30 ~ +125	$^\circ\text{C}$
—	Mounting torque		30	kg-cm
—			2.94	N-m
—	Weight	Typical value	20	g

**CR20F**

MEDIUM POWER USE

NON-INSULATED TYPE, GLASS PASSIVATION TYPE

**ELECTRICAL CHARACTERISTICS**

Symbol	Parameter	Test conditions	Limits			Unit
			Min.	Typ.	Max.	
IRRM	Repetitive peak reverse current	$T_j=125^\circ\text{C}$ , $V_{RRM}$ applied	—	—	4.0	mA
IDRM	Repetitive peak off-state current	$T_j=125^\circ\text{C}$ , $V_{DRM}$ applied	—	—	4.0	mA
$V_{TM}$	On-state voltage	$T_c=25^\circ\text{C}$ , $I_{TM}=60\text{A}$ , Instantaneous value	—	—	1.8	V
dv/dt	Critical-rate of rise of off-state voltage	$T_j=125^\circ\text{C}$ , $V_D=2/3V_{DRM}$	50	—	—	V
VGT	Gate trigger voltage	$T_j=25^\circ\text{C}$ , $V_D=6\text{V}$ , $I_T=0.5\text{A}$	—	—	3.0	V
VGD	Gate non-trigger voltage	$T_j=125^\circ\text{C}$ , $V_D=1/2V_{DRM}$	0.25	—	—	V
IGT	Gate trigger current	$T_j=25^\circ\text{C}$ , $V_D=6\text{V}$ , $I_T=0.5\text{A}$	—	—	50	mA
tgt	Turn-on time	$T_c=25^\circ\text{C}$ , $V_D=100\text{V}$ , $I_T=15\text{A}$ , $I_G=0.1\text{A}$	—	—	10	$\mu\text{s}$
Rth (j-c)	Thermal resistance	Junction to case	—	—	1.0	$^\circ\text{C}/\text{W}$
Rth (c-f)	Contact thermal resistance	Case to fin	—	—	0.4	$^\circ\text{C}/\text{W}$

**PERFORMANCE CURVES**

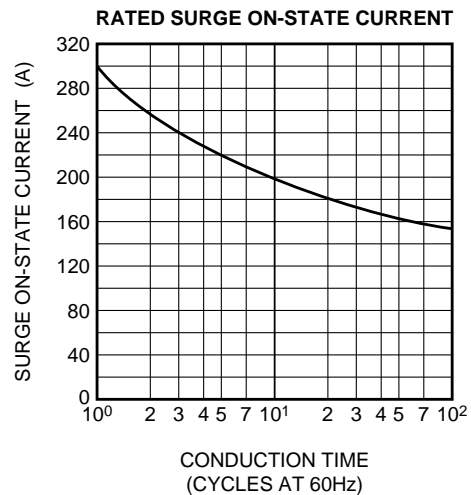
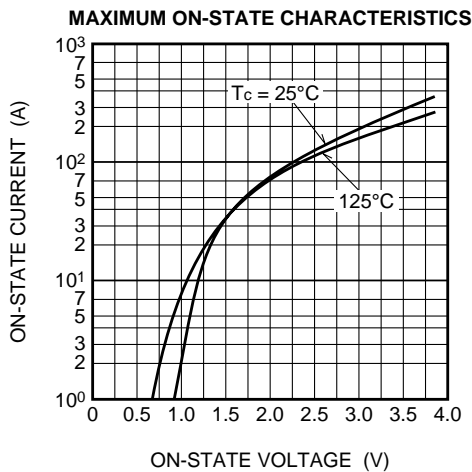

# CR20F

MEDIUM POWER USE

NON-INSULATED ALUMINUM TYPE, GLASS PASSIVATION TYPE

**GATE CHARACTERISTICS**

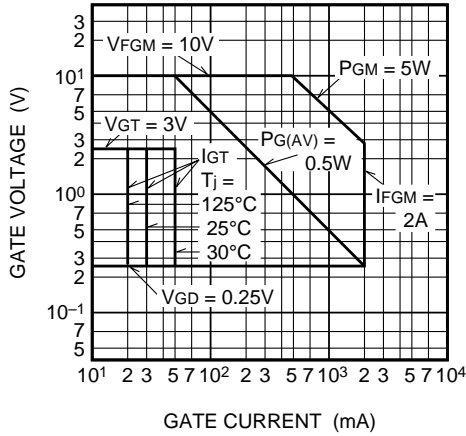

**MAXIMUM AVERAGE POWER DISSIPATION (SINGLE-PHASE HALF WAVE)**

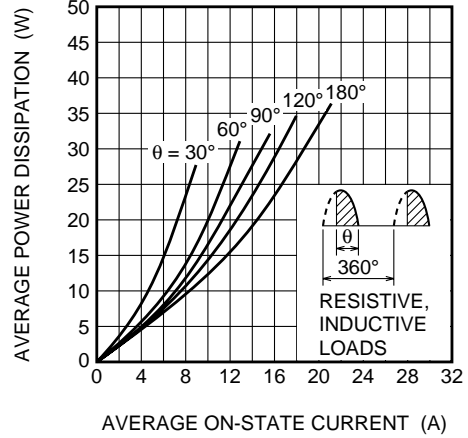

**ALLOWABLE CASE TEMPERATURE VS. AVERAGE ON-STATE CURRENT (SINGLE-PHASE HALF WAVE)**

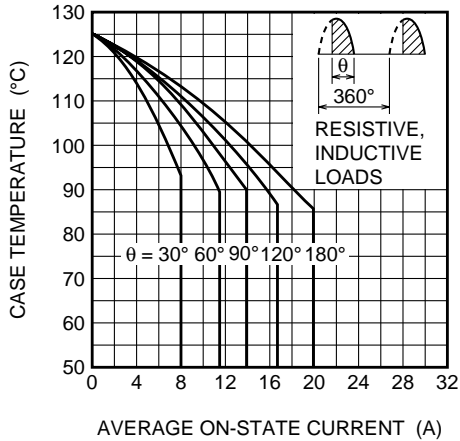

**ALLOWABLE AMBIENT TEMPERATURE VS. AVERAGE ON-STATE CURRENT (SINGLE-PHASE HALF WAVE)**

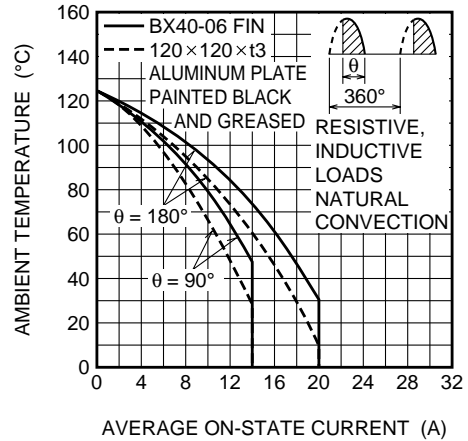

**MAXIMUM AVERAGE POWER DISSIPATION (SINGLE-PHASE FULL WAVE)**

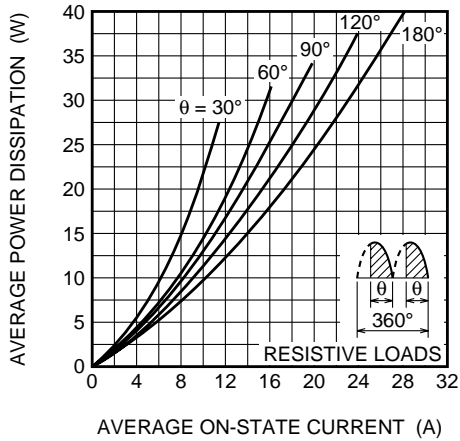

**ALLOWABLE CASE TEMPERATURE VS. AVERAGE ON-STATE CURRENT (SINGLE-PHASE FULL WAVE)**

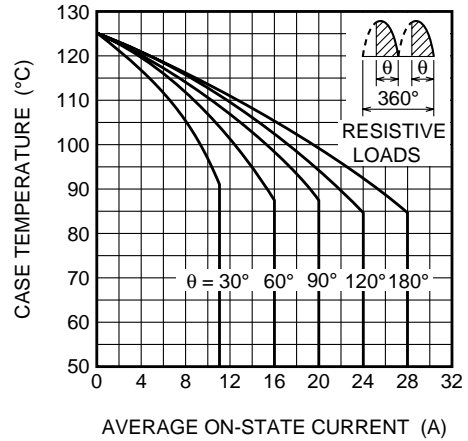

**CR20F**

MEDIUM POWER USE

NON-INSULATED TYPE, GLASS PASSIVATION TYPE

**ALLOWABLE AMBIENT TEMPERATURE VS. AVERAGE ON-STATE CURRENT (SINGLE-PHASE FULL WAVE)**

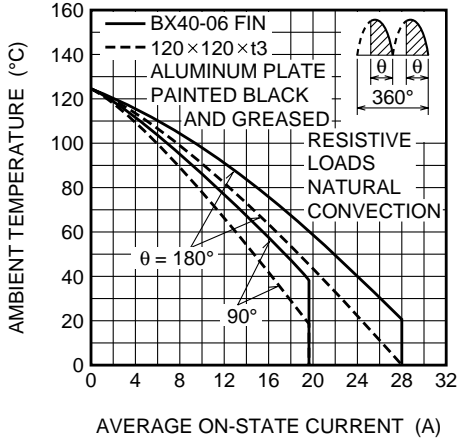

**MAXIMUM AVERAGE POWER DISSIPATION (RECTANGULAR WAVE)**

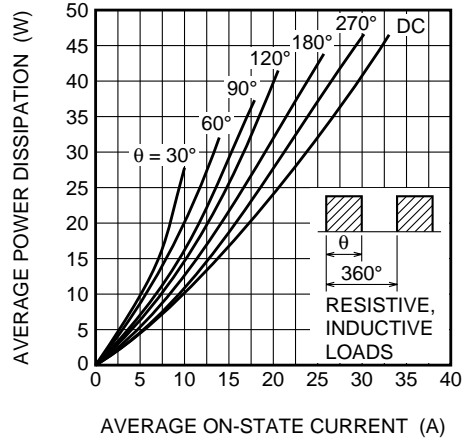

**ALLOWABLE CASE TEMPERATURE VS. AVERAGE ON-STATE CURRENT (RECTANGULAR WAVE)**

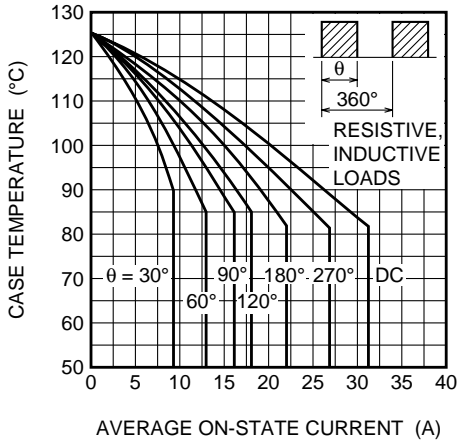

**ALLOWABLE AMBIENT TEMPERATURE VS. AVERAGE ON-STATE CURRENT (RECTANGULAR WAVE)**

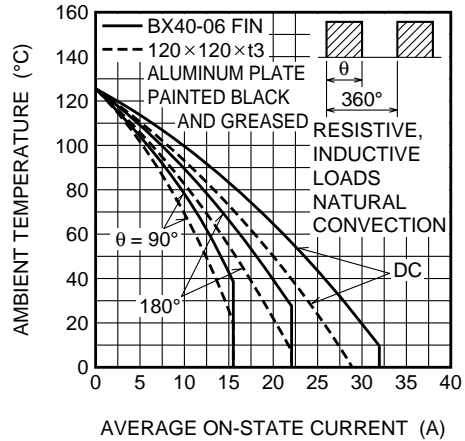

**CR20F BLOCK FIN BX40-06 OUTLINE DRAWING (Unit: mm)**

