

BCR8PM-18

MEDIUM POWER USE
INSULATED TYPE, PLANAR PASSIVATION TYPE

BCR8PM-18



- IT (RMS) 8A
- VDRM 900V
- I_{FGT I}, I_{RGT I}, I_{RGT III} 30mA
- V_{iso} 1500V
- UL Recognized: File No. E80276

OUTLINE DRAWING

Dimensions
in mm

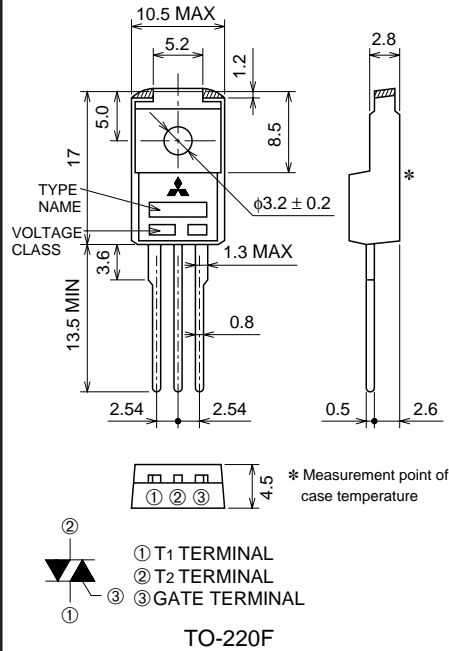

APPLICATION

Switching mode power supply, light dimmer, electric flasher unit, control of household equipment such as TV sets · stereo · refrigerator · washing machine · infrared kotatsu · carpet, solenoid drivers, small motor control, copying machine, electric tool, other general purpose control applications

MAXIMUM RATINGS

Symbol	Parameter	Voltage class		Unit
		18		
VDRM	Repetitive peak off-state voltage*1	900		V
VDSM	Non-repetitive peak off-state voltage*1	1100		V

Symbol	Parameter	Conditions	Ratings	Unit
I _T (RMS)	RMS on-state current	Commercial frequency, sine full wave 360° conduction, T _c =88°C	8	A
I _{TSM}	Surge on-state current	60Hz sinewave 1 full cycle, peak value, non-repetitive	80	A
i ² _t	i ² _t for fusing	Value corresponding to 1 cycle of half wave 60Hz, surge on-state current	26	A ² s
P _{GM}	Peak gate power dissipation		5	W
P _G (AV)	Average gate power dissipation		0.5	W
V _{GM}	Peak gate voltage		10	V
I _{GM}	Peak gate current		2	A
T _j	Junction temperature		-40 ~ +125	°C
T _{stg}	Storage temperature		-40 ~ +125	°C
—	Weight	Typical value	2.0	g
V _{iso}	Isolation voltage	T _a =25°C, AC 1 minute, T1 · T2 · G terminal to case	1500	V

*1. Gate open.

BCR8PM-18

MEDIUM POWER USE
INSULATED TYPE, PLANAR PASSIVATION TYPE

ELECTRICAL CHARACTERISTICS

Symbol	Parameter	Test conditions	Limits			Unit	
			Min.	Typ.	Max.		
IDRM	Repetitive peak off-state current	T _j =125°C, V _{DRM} applied	—	—	2.0	mA	
V _{TM}	On-state voltage	T _c =25°C, I _{TM} =12A, Instantaneous measurement	—	—	1.6	V	
V _{FGT I}	Gate trigger voltage *2	T _j =25°C, V _D =6V, R _L =6Ω, R _G =330Ω	I	—	—	1.5	V
V _{RGT I}			II	—	—	1.5	V
V _{RGT III}			III	—	—	1.5	V
I _{FGT I}	Gate trigger current *2	T _j =25°C, V _D =6V, R _L =6Ω, R _G =330Ω	I	—	—	30	mA
I _{RGT I}			II	—	—	30	mA
I _{RGT III}			III	—	—	30	mA
V _{GD}	Gate non-trigger voltage	T _j =125°C, V _D =1/2V _{DRM}	0.2	—	—	V	
R _{th(j-c)}	Thermal resistance	Junction to case *4	—	—	3.7	°C/W	
(dv/dt) _c	Critical-rate of rise of off-state commutating voltage		*3	—	—	V/μs	

*2. Measurement using the gate trigger characteristics measurement circuit.
 *3. The critical-rate of rise of the off-state commutating voltage is shown in the table below.
 *4. The contact thermal resistance R_{th(c-f)} in case of greasing is 0.5°C/W.

Voltage class	V _{DRM} (V)	(dv/dt) _c			Test conditions	Commutating voltage and current waveforms (inductive load)
		Symbol	Min.	Unit		
18	900	R	—	V/μs	1. Junction temperature T _j =125°C 2. Rate of decay of on-state commutating current (di/dt) _c =-4.0A/ms 3. Peak off-state voltage V _D =400V	
		L	10			

PERFORMANCE CURVES

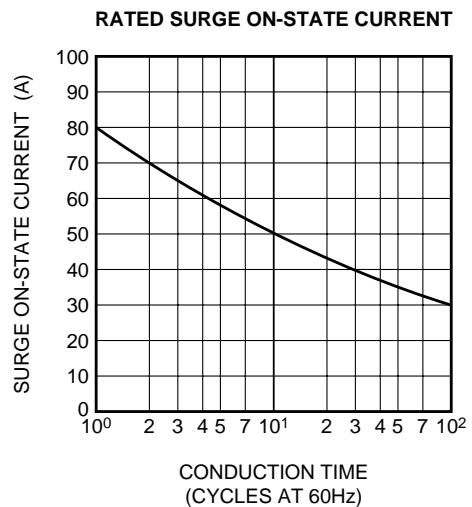
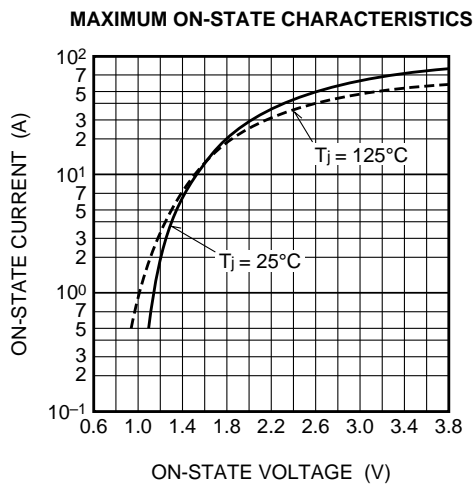

BCR8PM-18

MEDIUM POWER USE
INSULATED TYPE, PLANAR PASSIVATION TYPE

GATE CHARACTERISTICS

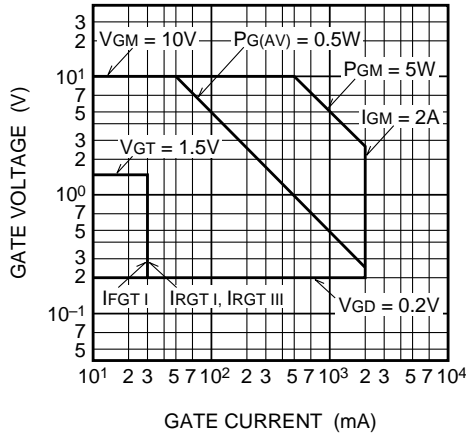

GATE TRIGGER CURRENT VS. JUNCTION TEMPERATURE

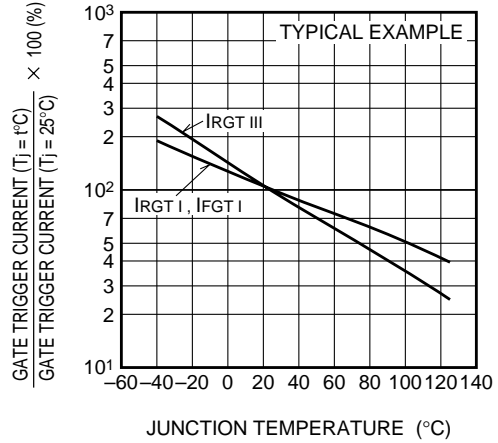

GATE TRIGGER VOLTAGE VS. JUNCTION TEMPERATURE

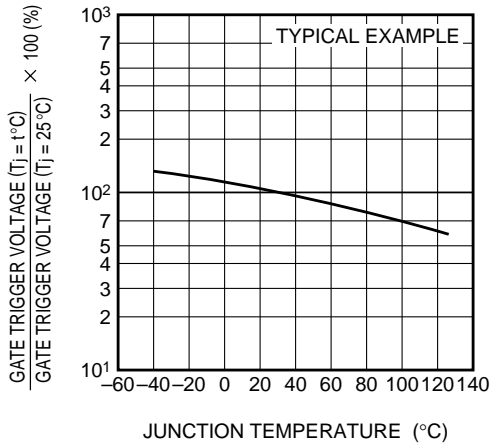

MAXIMUM TRANSIENT THERMAL IMPEDANCE CHARACTERISTICS (JUNCTION TO CASE)

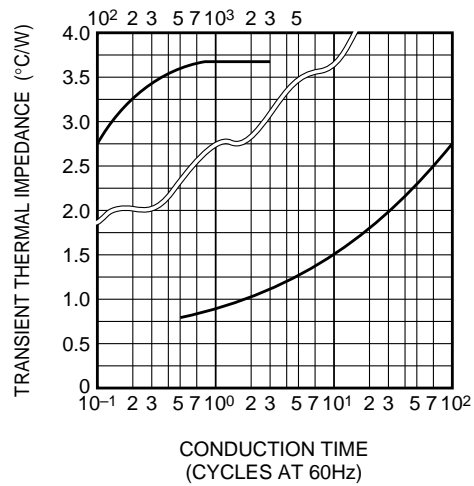

MAXIMUM TRANSIENT THERMAL IMPEDANCE CHARACTERISTICS (JUNCTION TO AMBIENT)

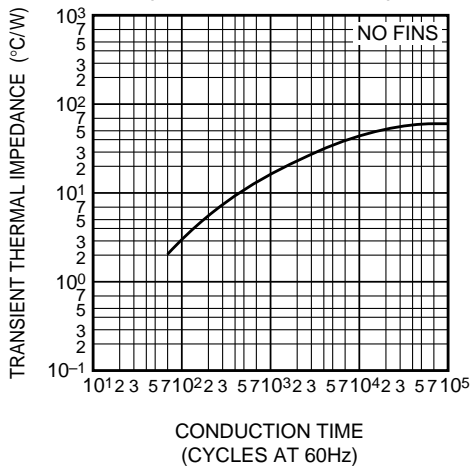

MAXIMUM ON-STATE POWER DISSIPATION

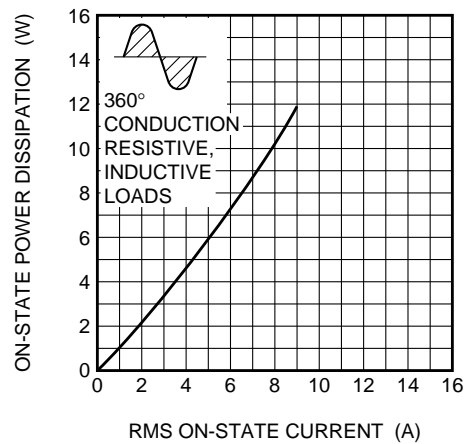

BCR8PM-18

MEDIUM POWER USE
INSULATED TYPE, PLANAR PASSIVATION TYPE

ALLOWABLE CASE TEMPERATURE VS. RMS ON-STATE CURRENT

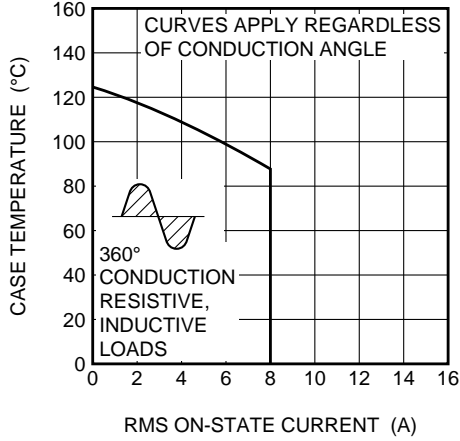

ALLOWABLE AMBIENT TEMPERATURE VS. RMS ON-STATE CURRENT

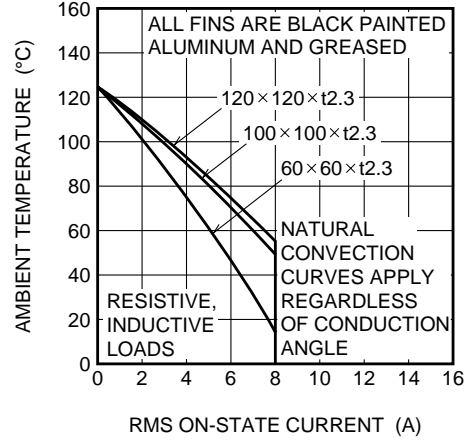

ALLOWABLE AMBIENT TEMPERATURE VS. RMS ON-STATE CURRENT

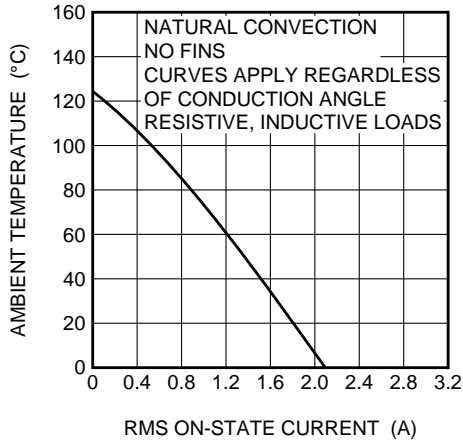

REPETITIVE PEAK OFF-STATE CURRENT VS. JUNCTION TEMPERATURE

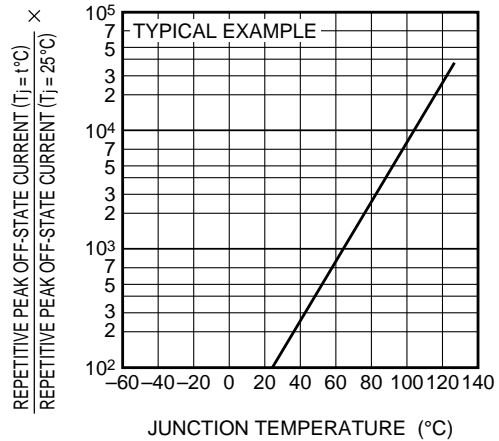

HOLDING CURRENT VS. JUNCTION TEMPERATURE

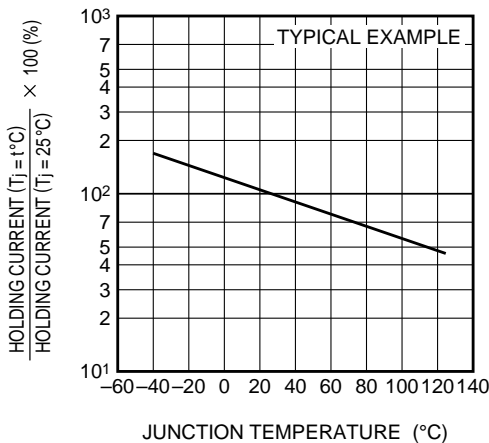

LACHING CURRENT VS. JUNCTION TEMPERATURE

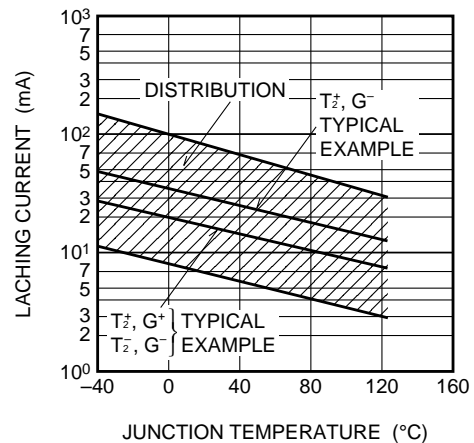

BCR8PM-18

MEDIUM POWER USE
INSULATED TYPE, PLANAR PASSIVATION TYPE

BREAKOVER VOLTAGE VS. JUNCTION TEMPERATURE

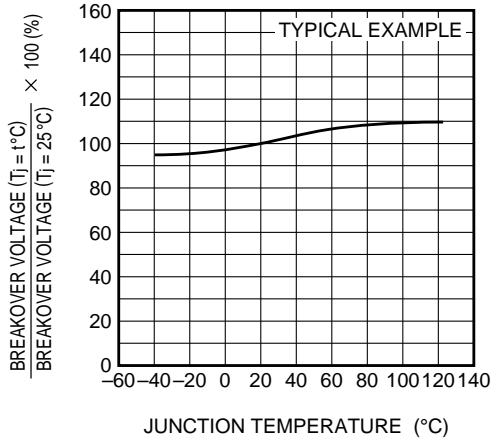

BREAKOVER VOLTAGE VS. RATE OF RISE OF OFF-STATE VOLTAGE

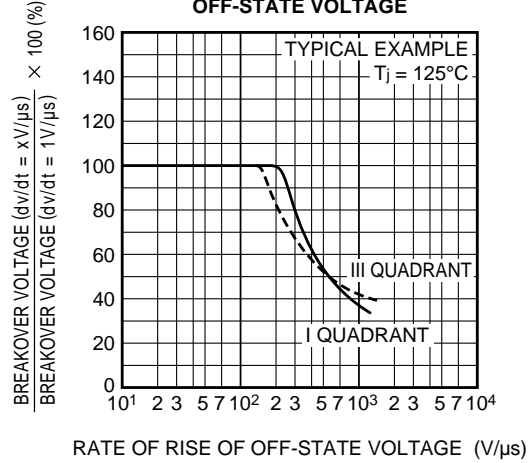

COMMUTATION CHARACTERISTICS

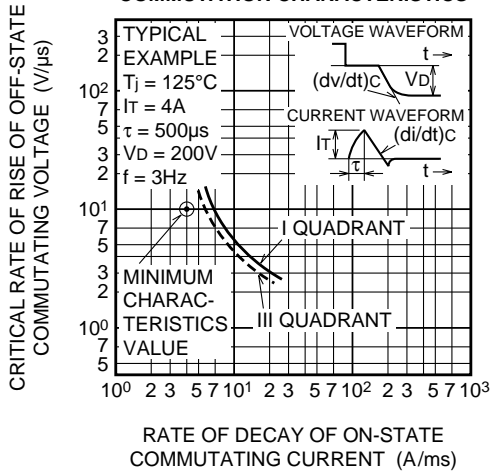

GATE TRIGGER CURRENT VS. GATE CURRENT PULSE WIDTH

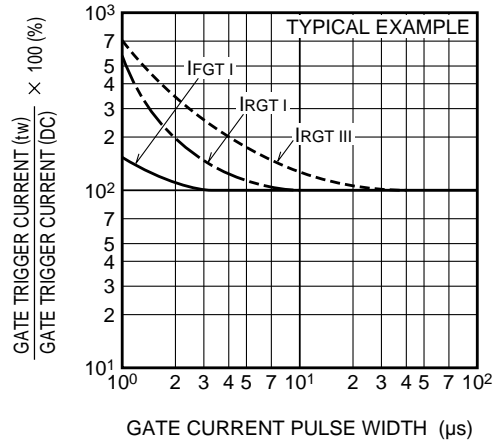

GATE TRIGGER CHARACTERISTICS TEST CIRCUITS

