

BCR16UM

MEDIUM POWER USE
INSULATED TYPE, GLASS PASSIVATION TYPE

BCR16UM

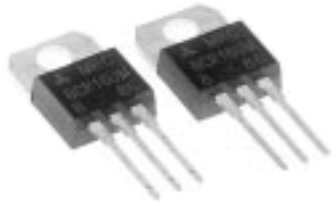

- IT (RMS) 16A
- VDRM 400V/600V
- IFGT I, IRGT I, IRGT III 15mA
- V_{iso} 1500V

OUTLINE DRAWING Dimensions
in mm

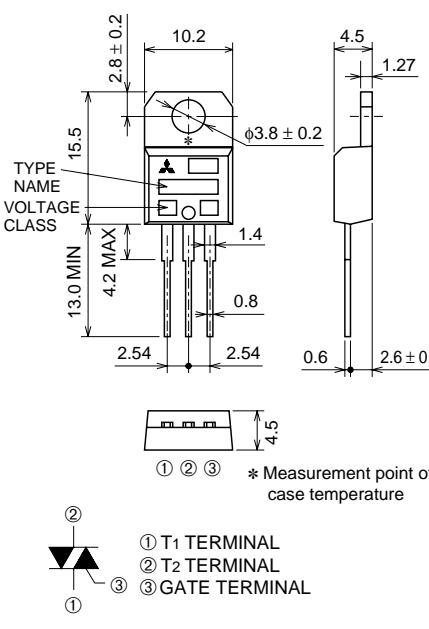

TYPE NAME
VOLTAGE CLASS

① ② ③ * Measurement point of case temperature

① T1 TERMINAL
② T2 TERMINAL
③ GATE TERMINAL

TO-220

APPLICATION

Light dimmer

MAXIMUM RATINGS

Symbol	Parameter	Voltage class		Unit
		8	12	
VDRM	Repetitive peak off-state voltage*1	400	600	V
VDSM	Non-repetitive peak off-state voltage*1	500	720	V

Symbol	Parameter	Conditions	Ratings	Unit
IT (RMS)	RMS on-state current	Commercial frequency, sine full wave 360° conduction, T _c =79°C*3	16	A
ITSM	Surge on-state current	60Hz sinewave 1 full cycle, peak value, non-repetitive	170	A
I ² _t	I ² _t for fusing	Value corresponding to 1 cycle of half wave 60Hz, surge on-state current	121	A ² s
PGM	Peak gate power dissipation		5	W
PG (AV)	Average gate power dissipation		0.5	W
VGM	Peak gate voltage		10	V
IGM	Peak gate current		2	A
T _j	Junction temperature		-40 ~ +125	°C
T _{stg}	Storage temperature		-40 ~ +125	°C
—	Weight	Typical value	2.3	g
V _{iso}	Isolation voltage	T _a =25°C, AC 1 minute, T1 · T2 · G terminal to case	1500	V

*1. Gate open.

BCR16UM

MEDIUM POWER USE
INSULATED TYPE, GLASS PASSIVATION TYPE

ELECTRICAL CHARACTERISTICS

Symbol	Parameter	Test conditions	Limits			Unit	
			Min.	Typ.	Max.		
IDRM	Repetitive peak off-state current	T _j =125°C, V _{DRM} applied	—	—	2.0	mA	
V _{TM}	On-state voltage	T _c =25°C, I _{TM} =25A, Instantaneous measurement	—	—	1.5	V	
V _{FGT I}	Gate trigger voltage *2	T _j =25°C, V _D =6V, R _L =6Ω, R _G =330Ω	I	—	—	1.5	V
V _{RGT I}			II	—	—	1.5	V
V _{RGT III}			III	—	—	1.5	V
I _{FGT I}	Gate trigger current *2	T _j =25°C, V _D =6V, R _L =6Ω, R _G =330Ω	I	—	—	15	mA
I _{RGT I}			II	—	—	15	mA
I _{RGT III}			III	—	—	15	mA
V _{GD}	Gate non-trigger voltage	T _j =125°C, V _D =1/2V _{DRM}	0.2	—	—	V	
R _{th(j-c)}	Thermal resistance	Junction to case *3 *4	—	—	2.5	°C/W	

*2. Measurement using the gate trigger characteristics measurement circuit.
 *3. Case temperature is measured at the T₂ terminal 1.5mm away from the molded case.
 *4. The contact thermal resistance R_{th(c-f)} in case of greasing is 1.0°C/W.

PERFORMANCE CURVES

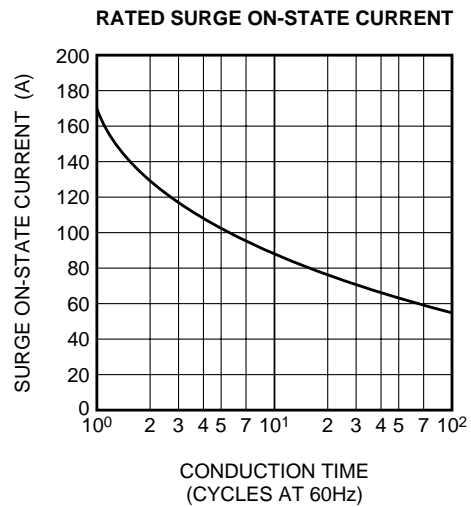
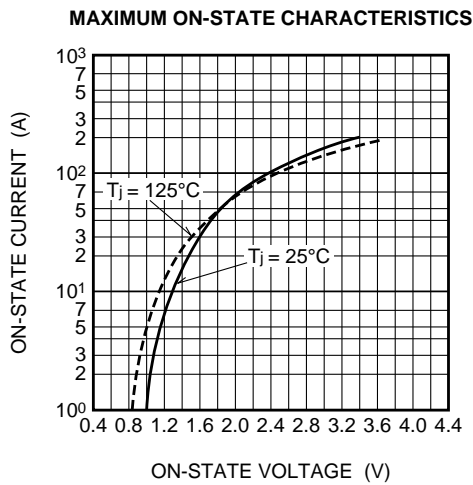

BCR16UM

MEDIUM POWER USE
INSULATED TYPE, GLASS PASSIVATION TYPE

GATE CHARACTERISTICS

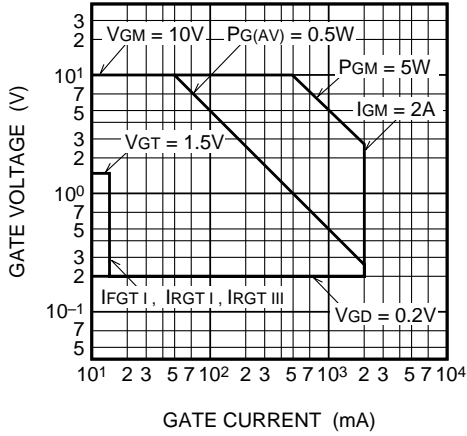

GATE TRIGGER CURRENT VS. JUNCTION TEMPERATURE

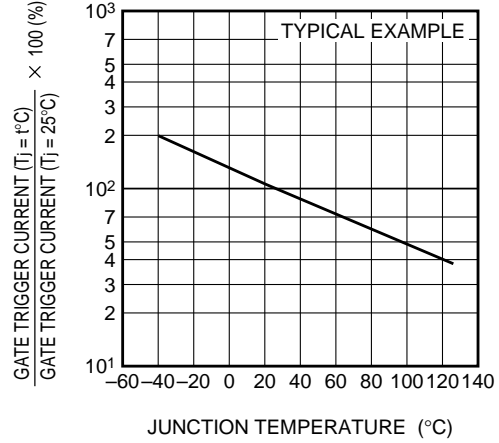

GATE TRIGGER VOLTAGE VS. JUNCTION TEMPERATURE

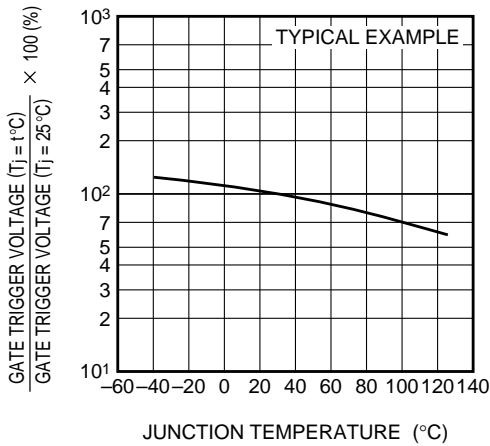

MAXIMUM TRANSIENT THERMAL IMPEDANCE CHARACTERISTICS (JUNCTION TO CASE)

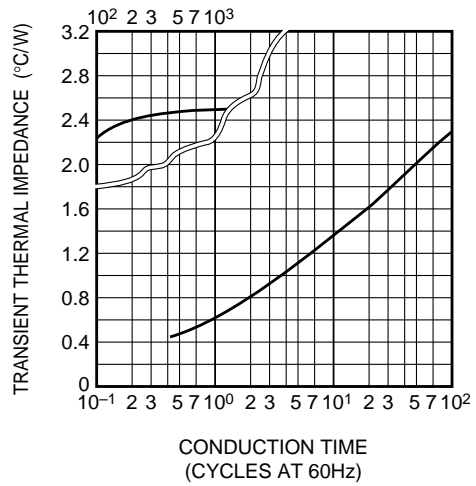

MAXIMUM ON-STATE POWER DISSIPATION

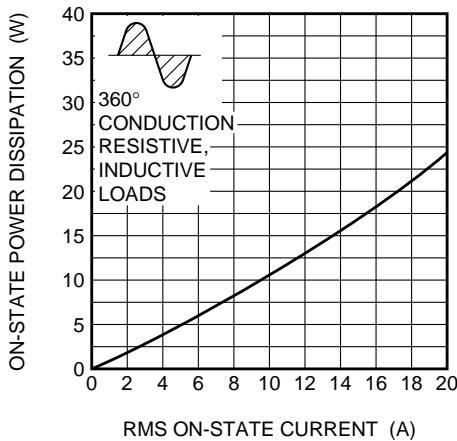

ALLOWABLE CASE TEMPERATURE VS. RMS ON-STATE CURRENT

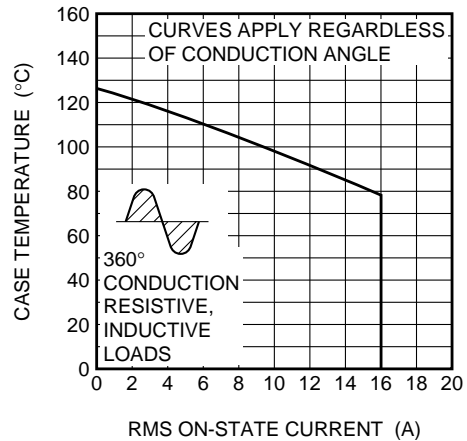

BCR16UM

MEDIUM POWER USE
INSULATED TYPE, GLASS PASSIVATION TYPE

ALLOWABLE AMBIENT TEMPERATURE VS. RMS ON-STATE CURRENT

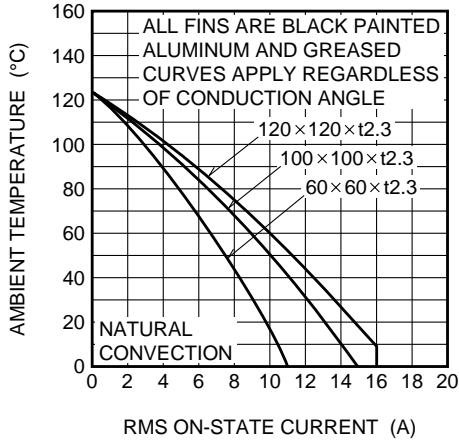

ALLOWABLE AMBIENT TEMPERATURE VS. RMS ON-STATE CURRENT

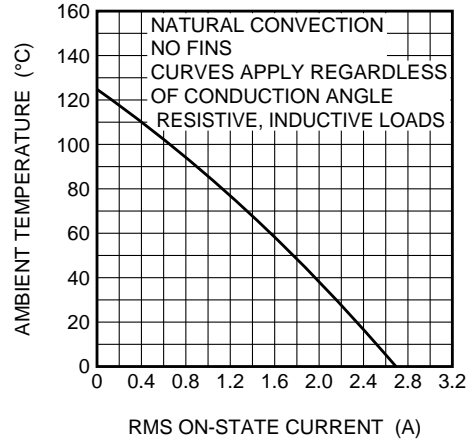

REPETITIVE PEAK OFF-STATE CURRENT VS. JUNCTION TEMPERATURE

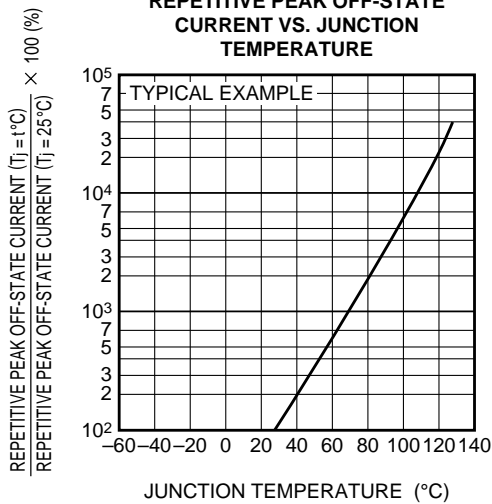

HOLDING CURRENT VS. JUNCTION TEMPERATURE

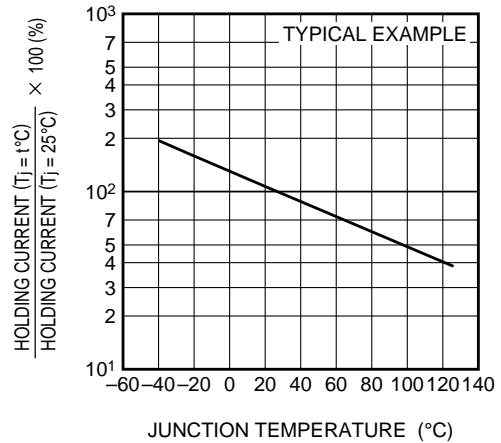

LATCHING CURRENT VS. JUNCTION TEMPERATURE

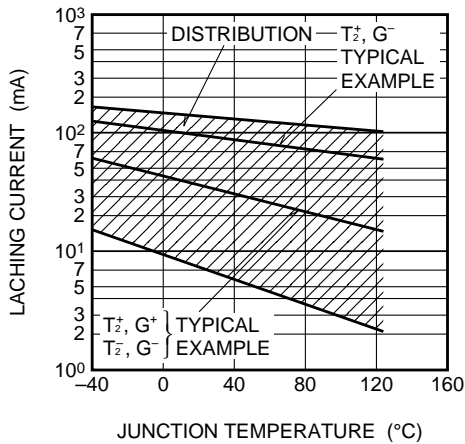

BREAKOVER VOLTAGE VS. JUNCTION TEMPERATURE

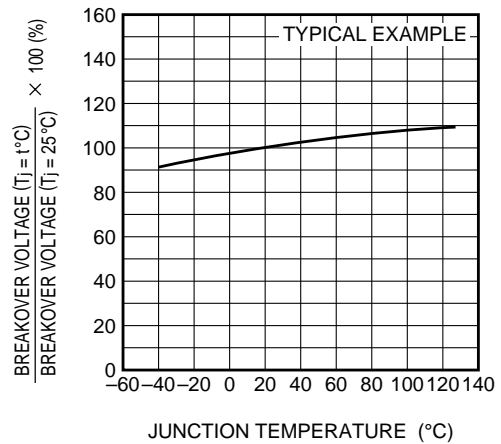

BCR16UM

MEDIUM POWER USE
INSULATED TYPE, GLASS PASSIVATION TYPE

**BREAKOVER VOLTAGE VS.
RATE OF RISE OF
OFF-STATE VOLTAGE**

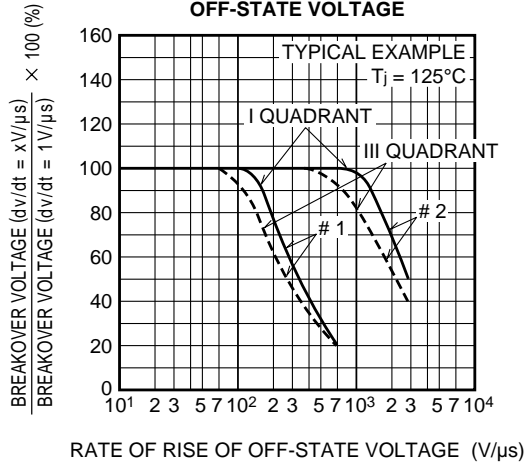

**GATE TRIGGER CURRENT VS.
GATE CURRENT PULSE WIDTH**

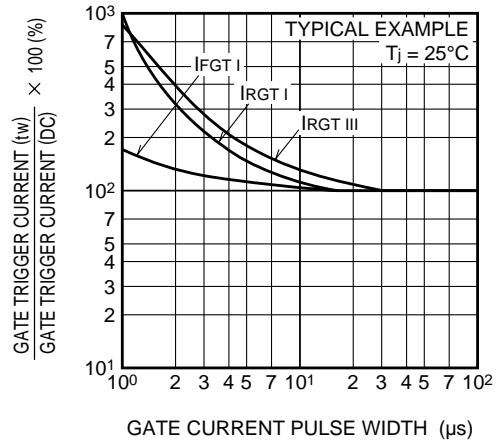

GATE TRIGGER CHARACTERISTICS TEST CIRCUITS

