

ATTENTION
OBSERVE PRECAUTIONS
FOR HANDLING
ELECTROSTATIC
SENSITIVE
DEVICES

MITSUBISHI RF POWER MODULE

M68779M

Silicon MOS FET Power Amplifier, 218-250MHz 7.0W FM PORTABLE

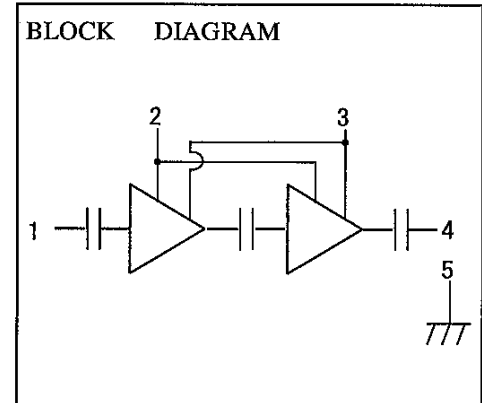
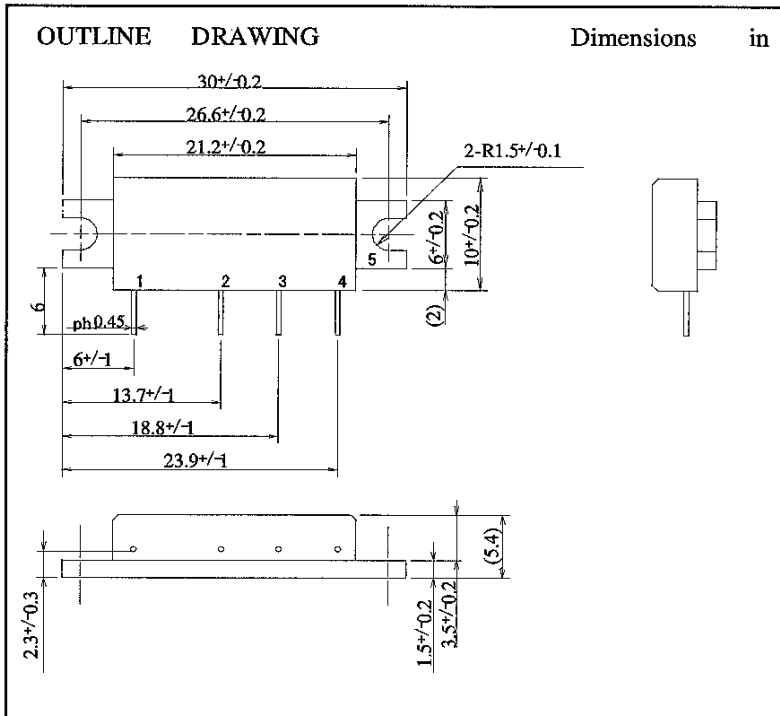

- PIN:**
- 1. Pin :RF INPUT
 - 2. V_{GG} :GATE BIAS SUPPLY
 - 3. V_{DD} :DRAIN BIAS SUPPLY
 - 4. P_O :RF OUTPUT
 - 5. GND :FIN

MAXIMUM RATINGS (T_c=25deg.C UNLESS OTHERWISE NOTED)

SYMBOL	PARAMETER	CONDITIONS	RATINGS	UNIT
V _{DD}	SUPPLY VOLTAGE	V _{GG} <3.5V, Z _g =Z _l =50ohm	9.2	V
V _{GG}	GATE BIAS VOLTAGE		4	V
P _{in}	INPUT POWER	f=218-250MHz, Z _g =Z _l =50ohm	50	mW
P _o	OUTPUT POWER	f=218-250MHz, Z _g =Z _l =50ohm	10	W
T _{c(OP)}	OPERATION CASE TEMPERATURE	f=218-250MHz, Z _g =Z _l =50ohm	-30 to +100	deg.C
T _{stg}	STORAGE TEMPERATURE		-40 to +110	deg.C

Note: Above parameters are guaranteed independently.

ELECTRICAL CHARACTERISTICS (T_c=25deg.C, Z_g=Z_l=50ohm UNLESS OTHERWISE NOTED)

SYMBOL	PARAMETER	CONDITIONS	LIMITS		UNIT
			MIN	MAX	
f	FREQUENCY RANGE		218	250	MHz
P _o	OUTPUT POWER	V _{dd} =7.2V, V _{gg} =3.5V, P _{in} =30mW	7.0		W
η _t	TOTAL EFFICIENCY	P _o =6.0W, (V _{gg} =adj.),	45		%
2f _o	2nd HARMONIC	P _{in} =30mW,		-25	dBc
V _{SWR in}	INPUT VSWR	V _{dd} =7.2V		5	-
	Stability	Z _g =50ohm, V _{dd} =6/ 7.2/ 9.2V, LOAD VSWR < 4:1 P _{in} =20/ 30/ 50mW, P _o <8W	No parasitic oscillation		
	LOAD VSWR TOLERANCE	V _{dd} =9.2V, P _{in} =30mW, P _o =7.0W (V _{gg} ADJUST), ρ _l =20:1	No degradation or destroy		-

ABOVE PARAMETERS, RATINGS, LIMITS AND CONDITIONS ARE SUBJECT TO CHANGE .

Keep safety first in your circuit designs!

Mitsubishi Electric Corporation puts the maximum effort into making semiconductor products better and more reliable, but there is always the possibility that trouble may occur with them. Trouble with semiconductors may lead to personal injury, fire or property damage. Remember to give due consideration to safety when making your circuit designs, with appropriate measures such as (i) placement of substitutive, auxiliary circuits, (ii) use of non-flammable material or (iii) prevention against any malfunction or mishap.

TYPICAL PERFORMANCE DATA

OUTPUT POWER, TOTAL EFFICIENCY, INPUT VSWR VS. FREQUENCY

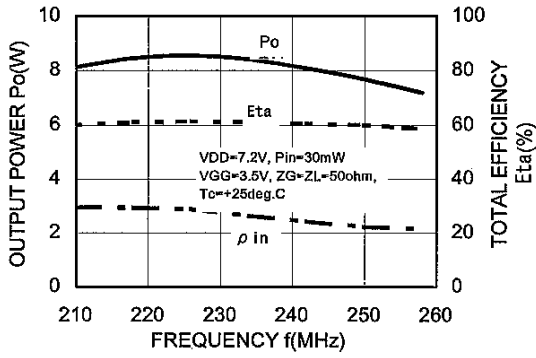

OUTPUT POWER, EFFICIENCY VS. INPUT POWER

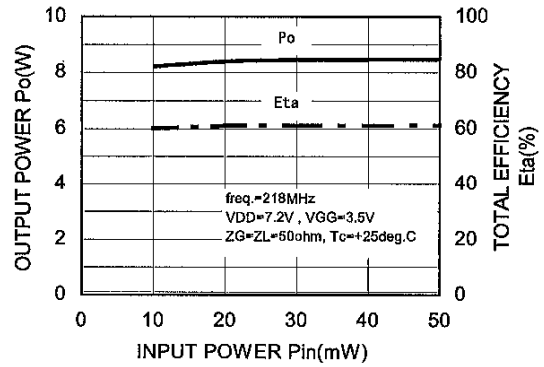

OUTPUT POWER, EFFICIENCY VS. INPUT POWER

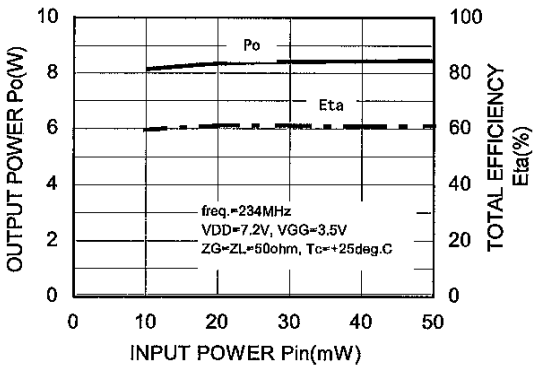

OUTPUT POWER, EFFICIENCY VS. INPUT POWER

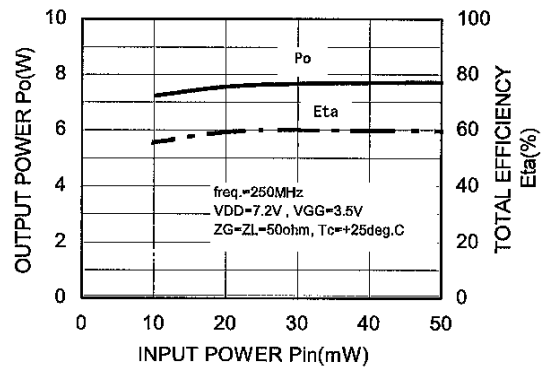

OUTPUT POWER, EFFICIENCY VS. DRAIN SUPPLY VOLTAGE

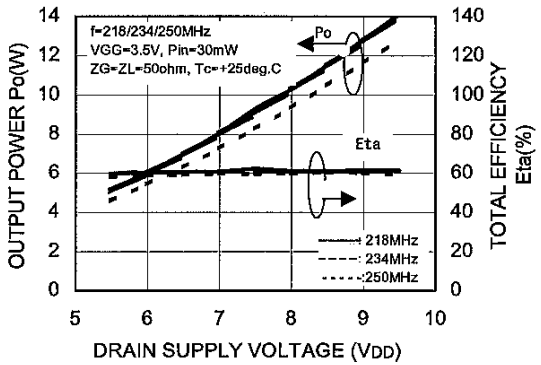

OUTPUT POWER, EFFICIENCY VS. GATE SUPPLY VOLTAGE

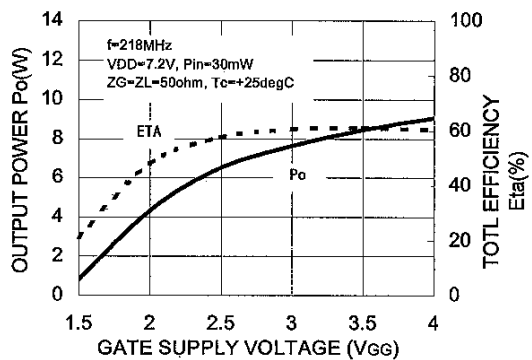

OUTPUT POWER, EFFICIENCY VS. GATE SUPPLY VOLTAGE

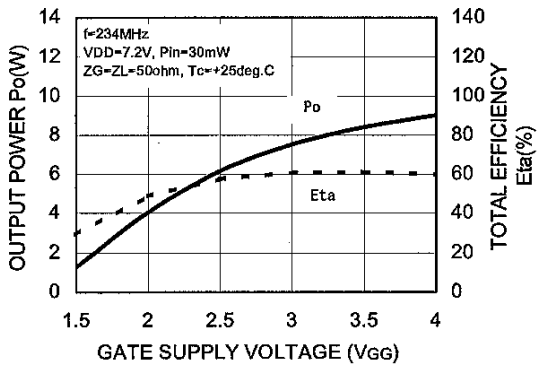

OUTPUT POWER, EFFICIENCY VS. GATE SUPPLY VOLTAGE

