

M5294P

SYSTEM RESET IC WITH LOW INPUT-OUTPUT VOLTAGE DIFFERENTIAL TYPE $\pm 5V$ REGULATOR, AND 3.0V REGULATOR FOR MUTE FUNCTION

DESCRIPTION

M5294P is a semiconductor integrated circuit designed for dual tracking type voltage regulator, which includes system reset circuit, and 3.0V regulator for mute function.

Since the output voltage ($\pm 5V$, 3V) are fixed inside, and this IC includes pull-up resistor (10k Ω) of reset output, User can omit the outside parts. $\pm 5V$ output is low power dissipation type, that is to say, this is able to operate even if input-output voltage difference is very low status such as 0.2V (@ $I_O = \pm 100mA$). Therefore, User can shrink the input transformer.

User can prevent making a noise by means of operating mute function before Power supply ($\pm 5V$) of Amplifier starts up, for 3.0V regulator for mute function starts up earlier than $\pm 5V$ output.

FEATURES

- Fixed output voltage
- Power supply for mute function
- Very low input-output voltage differential operation
- Current limiting circuit
 - $\pm 5V$ output short circuit protection with current fold back
 - mute output short circuit protection
- Thermal protection circuit
- Capable on/off control (11-pin terminal)
- Internal system reset circuit with pull-up resistor, hysteresis detectable voltage 3.9V (delay time is variable by connecting capacity at 7-pin terminal)

APPLICATION

CD, VCR and dual power supply power system

PIN CONFIGURATION (TOP VIEW)

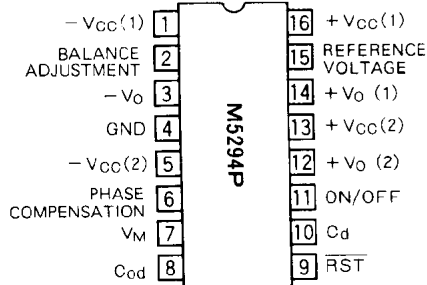

Outline 16P4

- Note 1: Please use the capacitor not to depend on the ambient temperature.
 2: Please connect $-V_{CC}(1)$ and $-V_{CC}(2)$, $+V_{CC}(1)$ and $+V_{CC}(2)$, $+V_O(1)$ and $+V_O(2)$, firmly each other.

EQUIVALENT CIRCUIT DIAGRAM

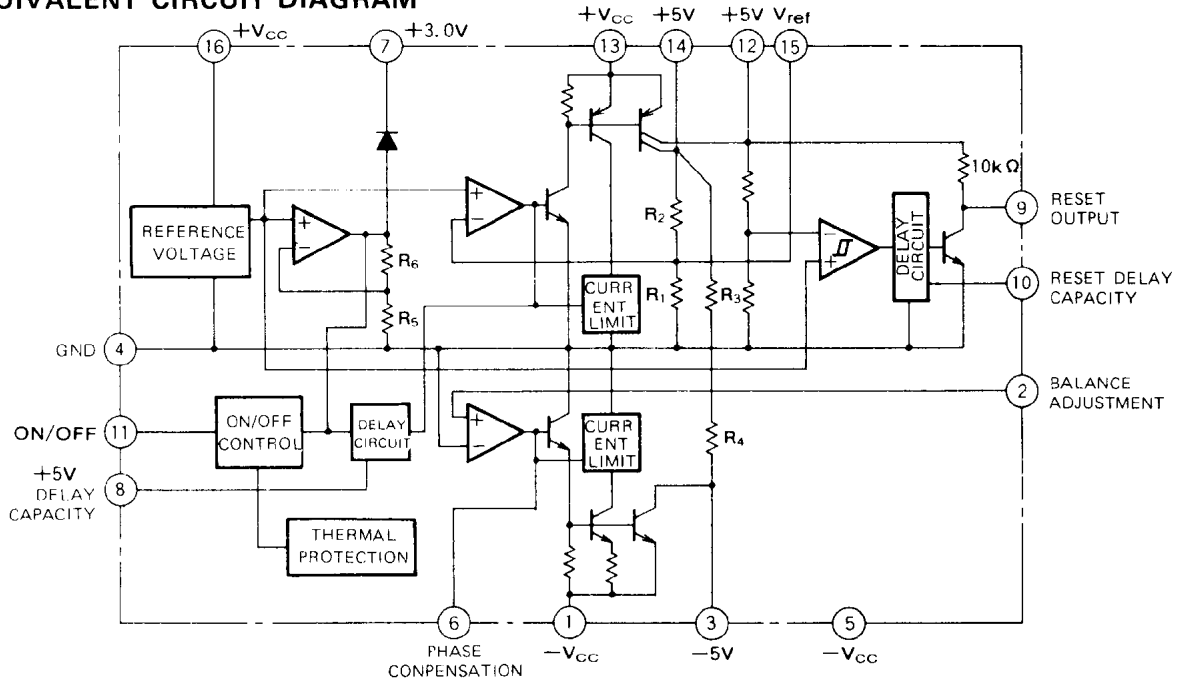

SYSTEM RESET IC WITH LOW INPUT-OUTPUT VOLTAGE DIFFERENTIAL TYPE $\pm 5V$ REGULATOR, AND 3.0V REGULATOR FOR MUTE FUNCTION

ABSOLUTE MAXIMAM RATINGS (Ta = 25 °C, unless otherwise noted)

Symbol	Parameter	Conditions	Ratings	Unit
V _{CC}	Supply voltage		$\pm 15(30)$	V
I _{LP⊕}	Positive load current		+ 200	mA
I _{LP⊖}	Negative load current		- 200	mA
I _{LPM}	Mute regulator load current		10	mA
V _{DIF}	Input/Output voltage difference		± 10	V
P _d	Power dissipation		1.0 without sheet for setting free fever	W
K _θ	Thermal derating	Ta $\geq 25^{\circ}\text{C}$	10.0 without sheet for setting free fever	mW/°C
T _{opr}	Ambient temperature		- 20 ~ + 75	°C
T _{stg}	Storage temperature		- 55 ~ + 125	°C

THERMAL DELATING

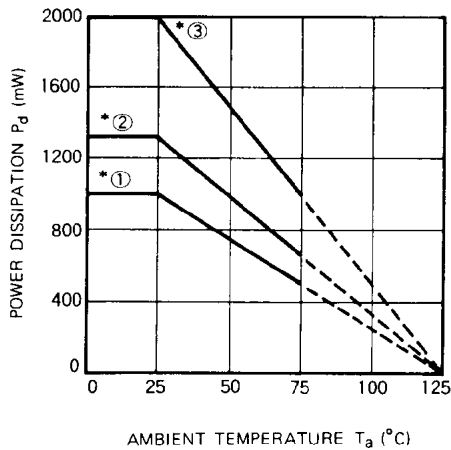

*① Condition as follow

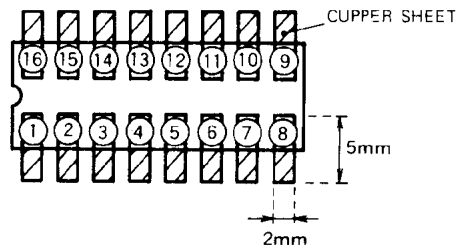

*② Condition as follow

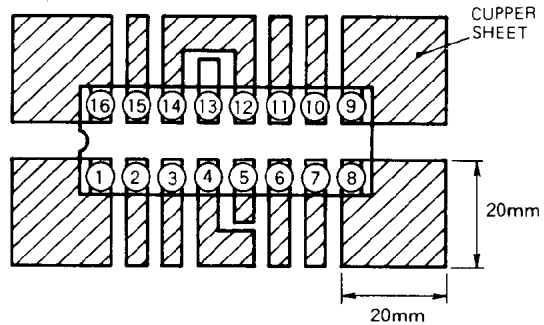

*③ Allowable Power dissipation in setting free fever infinityly

When the Power loss in the IC is large, please design for setting free fever not to be 125°C at junction.

SYSTEM RESET IC WITH LOW INPUT-OUTPUT VOLTAGE DIFFERENTIAL TYPE $\pm 5V$ REGULATOR, AND 3.0V REGULATOR FOR MUTE FUNCTION

ELECTRICAL CHARACTERISTICS ($V_{IN} = \pm 7V, I_{O\pm} = 100mA, I_{O\ominus} = -100mA, T_a = 25^\circ C$)

Symbol	Parameter	Test conditions	Limits			Unit
			Min	Typ	Max	
$\pm I_{CC}$	Positive circuit current	without load	—	6	10	mA
$\ominus I_{CC}$	Negative circuit current	without load	—	-1.5	-5.0	mA
$I_{LOSS\pm 1}$	Loss current	$I_{O\pm} = 100mA$	—	10	30	mA
$I_{LOSS\pm 2}$		$I_{O\pm} = 200mA$	—	30	90	mA
$I_{LOSS\ominus 1}$		$I_{O\ominus} = -100mA$	—	-2	-20	mA
$I_{LOSS\ominus 2}$		$I_{O\ominus} = -200mA$	—	-5	-40	mA

REGULATOR PART

Symbol	Parameter	Test conditions	Limits			Unit
			Min	Typ	Max	
V_O	Output voltage		± 4.75	± 5.0	± 5.25	V
REG-in	Input voltage rejection	$V_{CC} \pm 6 \sim \pm 10V$	—	0.05	0.2	%/V
REG-o	Loading voltage rejection	$I_O = 1 \sim 100mA$	—	20	100	mV
$R.R(\oplus)$	Positive ripple rejection	$C_{REF} = 1\mu F, f = 120Hz$	60	85	—	dB
$R.R(\ominus)$	Negative ripple rejection	$C_{REF} = 1\mu F, f = 120Hz$	50	60	—	dB
$\Delta V(\oplus\ominus)$	Dual voltage tracking		—	0.5	5	%
V_{NO}	Output noise voltage	$f = 20Hz \sim 100kHz$	—	20	—	μV_{rms}
$V_{O(cri)}$	Output cut-off voltage	$0V \leq \text{pin voltage} \leq 0.2V$	—	—	0.1	V
V_{ref}	Reference input voltage		1.13	1.24	1.36	V
$V_{DIF\oplus}$	Input-Output voltage differential	$I_{O\pm} = 100mA$	—	0.2	0.5	V
$V_{DIF\ominus}$	Input-Output voltage differential	$I_{O\ominus} = -100mA$	—	0.2	0.5	V
T_{od}	Output delay time *1	$C_{od} = 0.1\mu F$	4.5	9	18	mS
$I_{OS\oplus}$	Output short current	$T_J = 125^\circ C$	—	30	—	mA
$I_{OS\ominus}$		$T_J = 125^\circ C$	—	30	—	mA

MUTE REGULATOR PART

Symbol	Parameter	Test conditions	Limits			Unit
			Min	Typ	Max	
V_M	Mute output voltage	$I_{LM} = 3mA$	2.7	3.0	3.3	V
V_{DIFM}	Input/Output voltage difference	$I_{LM} = 3mA$	—	2.5	3.2	V

RESET PART

Symbol	Parameter	Test conditions	Limits			Unit
			Min	Typ	Max	
V_S	Detected voltage		3.70	3.9	4.10	V
ΔV_S	Hysteresis voltage		50	100	200	mV
T_{pd}	Delay time *2	$C_d = 0.1\mu F$	5.5	11	22	mS
V_{sat}	Output saturation voltage	$R_L = 10k\Omega$	—	0.2	0.4	V

* 1. The period by when +5V output starts up since MUTE Reg. rises up to 1.5V.
 * 2. Reset output includes resistor (10k Ω) from the +5V output, but output saturation voltage is condition with outside resistor (10k Ω).

**SYSTEM RESET IC WITH LOW INPUT-OUTPUT VOLTAGE DIFFERENTIAL
TYPE $\pm 5V$ REGULATOR, AND 3.0V REGULATOR FOR MUTE FUNCTION**

TYPICAL CHARACTERISTICS

**CIRCUIT CURRENT VS.
POWER SUPPLY**

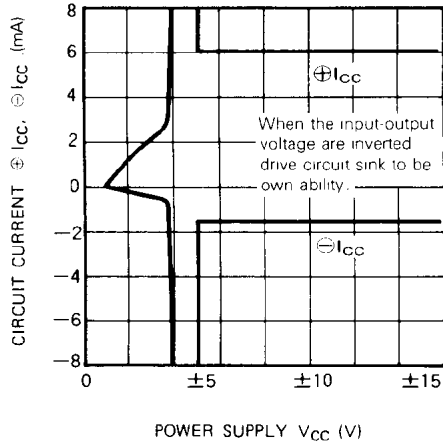

**CIRCUIT CURRENT VS.
AMBIENT TEMPERATURE**

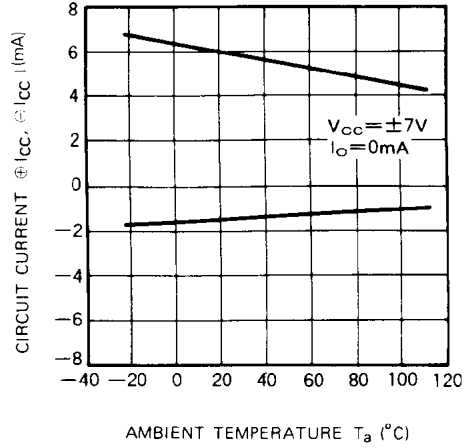

**OUTPUT VOLTAGE VS.
POWER SUPPLY**

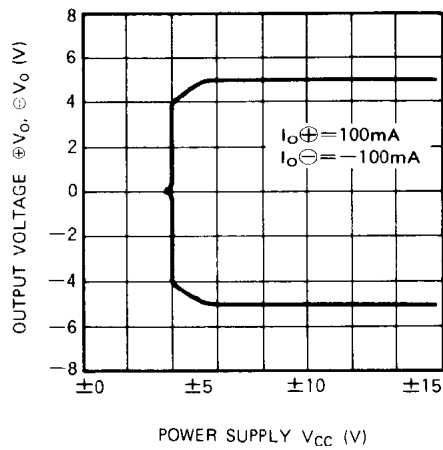

**OUTPUT VOLTAGE VS.
AMBIENT TEMPERATURE**

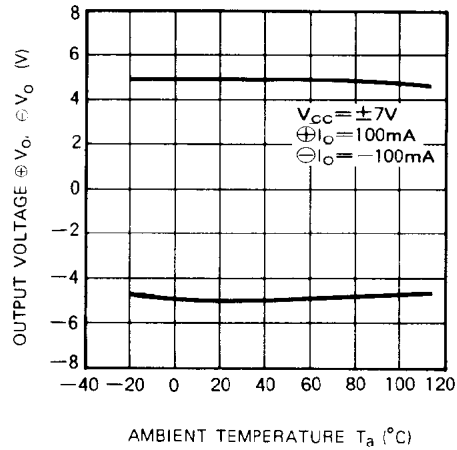

**OUTPUT SHORT CURRENT VS.
JUNCTION TEMPERATURE**

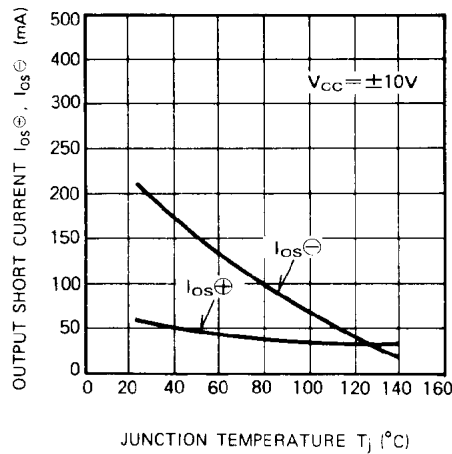

RIPPLE REJECTION VS. FREQUENCY

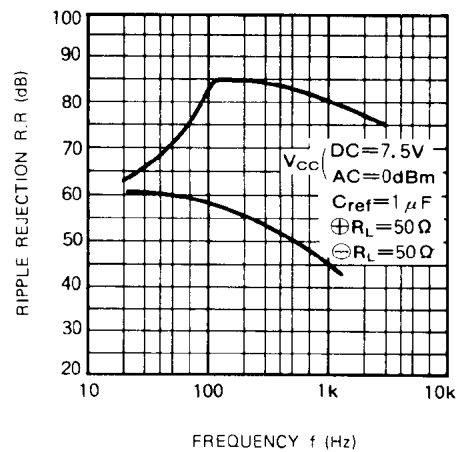

M5294P

SYSTEM RESET IC WITH LOW INPUT-OUTPUT VOLTAGE DIFFERENTIAL TYPE $\pm 5V$ REGULATOR, AND 3.0V REGULATOR FOR MUTE FUNCTION

MUTE VOLTAGE VS. POWER SUPPLY

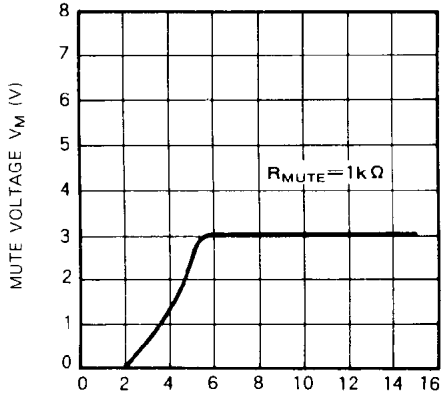

POSITIVE POWER SUPPLY $+V_{CC}$ (V)

RESET OUTPUT SATURATION VOLTAGE VS. AMBIENT TEMPERATURE

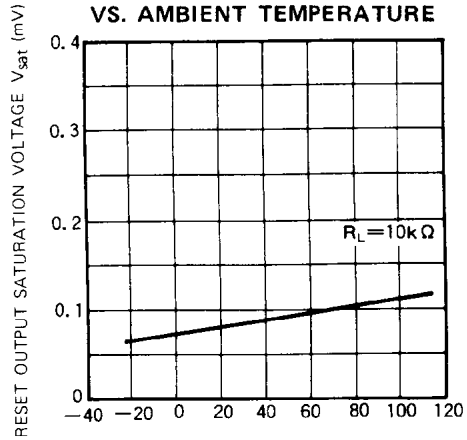

AMBIENT TEMPERATURE T_a ($^{\circ}C$)

RESET OUTPUT SATURATION VOLTAGE VS. RESET OUTPUT REJECTION

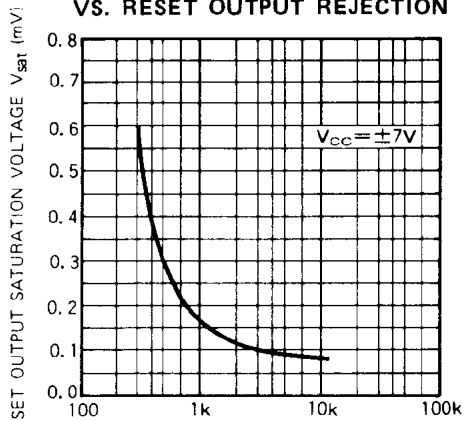

RESET OUTPUT REJECTION R_L (K Ω)

DELAY TIME VS. DELAY CAPACITY

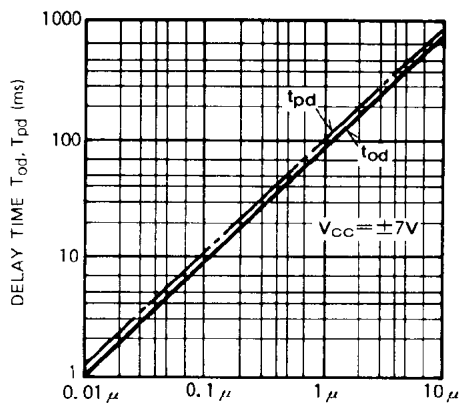

DELAY CAPACITY C_{od}, C_d (F)

SYSTEM RESET IC WITH LOW INPUT-OUTPUT VOLTAGE DIFFERENTIAL TYPE ±5V REGULATOR, AND 3.0V REGULATOR FOR MUTE FUNCTION

OUTPUT TIMING CHART

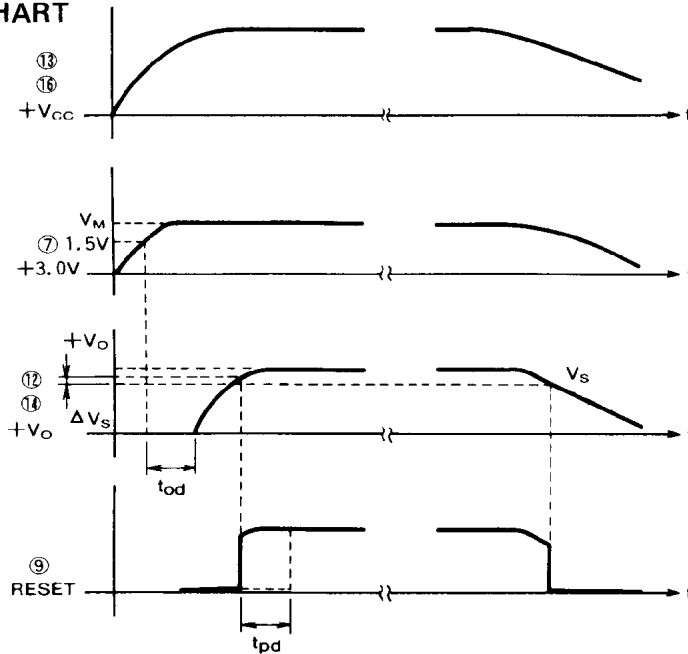

OPERATING EXPLANATION

- ① M5294P amplifies the stable reference voltage, and it makes Mute voltage V_M (3.0V) and Positive output voltage +V_O (5.0V).

$$V_M = V_{ref} \times \left(1 + \frac{R_6}{R_5}\right) - V_F$$

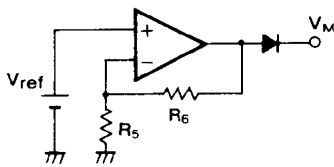

$$+V_O = V_{ref} \times \left(1 + \frac{R_2}{R_1}\right)$$

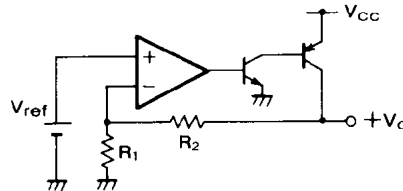

+V_O is inverted by this IC, and makes -V_O. (Therefore, -V_O depend on +V_O)

$$-V_O = -\frac{R_4}{R_3} \times V_O$$

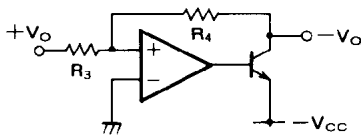

Each ±V_O includes the short-circuit protection with current foldback.
 ±V_M includes the short-circuit protection without current foldback.

- ② +V_O (±5V) output rise up since V_M (1.5V) rises up to 1.5V.
 +V_O output delay time T_{od} is set by adding external capacitor C_{od}.
 $T_{od} = 9 \times 10^4 \times C_{od} \text{ (s)}$
- ③ Low Reset output is cancelled when +V_O output rises up to V_S + ΔV_S (4.0V TYP). The delay time T_{od} is set by adding external capacitor C_d.
 $T_{pd} = 11 \times 10^4 \times C_d \text{ (s)}$
- ④ V_M is composed through the diode, therefore the transient time rises varies by external capacity and load condition. Consequently, ±V_O had been down, and if your system needs MUTE voltage, you have to increase the external capacity.
- ⑤ The Reset output is low when the +V_O is down to V_S (3.9V).

M5294P

SYSTEM RESET IC WITH LOW INPUT-OUTPUT VOLTAGE DIFFERENTIAL TYPE $\pm 5V$ REGULATOR, AND 3.0V REGULATOR FOR MUTE FUNCTION

TYPICAL APPLICATION

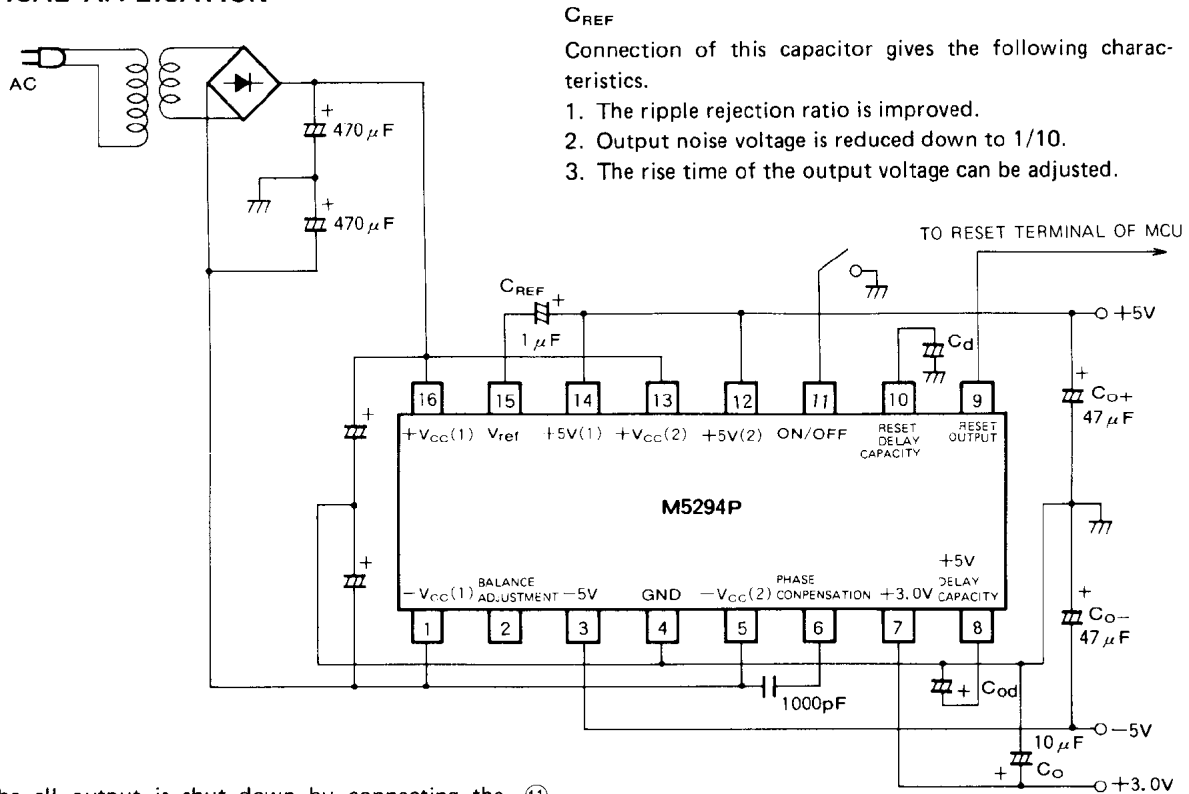

C_{REF}

Connection of this capacitor gives the following characteristics.

1. The ripple rejection ratio is improved.
2. Output noise voltage is reduced down to 1/10.
3. The rise time of the output voltage can be adjusted.

The all output is shut down by connecting the ⑪ terminal to GND level ($0 \leq V_{⑪} \leq 0.2V$).

When $-V_O$ is shorted to GND, $-V_O$ sometimes causes OSC condition, therefore please add the capacitor between ⑥ and ⑤ terminal. The capacity is about 1000pF.

1. In adjusting the output voltage (use ⑮ pin)

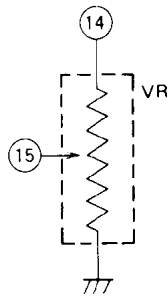

M5294P is fixed the output voltage by inside resistors, but user can adjust it by using the outside resistor. (inside resistor: $1.6K\Omega$ ⑮ to ④ $4.85K\Omega$ ④ to ⑮)

2. In adjusting the tracking voltage (user ② pin)

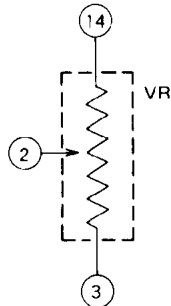

M5294P is fixed the tracking voltage by inside resistor, but user can adjust it by using the output resistor. (inside resistor: ⑭ to ② ② to ③, $5K\Omega$)