

MITSUBISHI (DIGITAL ASSP)
M75176P, M75177P
M75178P, M75179P

RS-485 TRANSCEIVER

DESCRIPTION

Each of the M75176 to M75179 is a semiconductor IC with a built-in differential driver and a built-in differential receiver both of which meet the EIA standards RS-422A and RS-485.

FEATURES

Common

- 5V single power supply
- With output control input (except M75179P)

Driver

- 54Ω terminal resistor connectable between outputs.
- High output impedance at power-OFF time
- Built-in output current limit circuit

Receiver

- High input sensitivity (±200mV max.)
- Hysteresis input (50mV typ.)
- High input impedance (12kΩ min.)
- "H" emitted when input is open (failsafe function)

APPLICATION

High-speed data transmission interface for digital equipment

DESCRIPTION OF FUNCTION

The M75176P to M75179P are line interface ICs which meet EIA standards RS-422A and RS-485, and are suitable for long-distance, high-speed data transmission.

The M75176P is designed to connect the driver circuit output and the receiver input to each other internally, and serves as a line transceiver. The M75177P/M75178P is designed to connect the receiver circuit output and the driver circuit input internally, and serves as a line repeater. The M75177P and M75178P enter the output enabled state with active "H" and active "L", respectively. The M75179P is equipped with a built-in differential driver and a built-in differential receiver. It does not have an output control input pin but its output impedance at the power-OFF time goes high.

PIN CONFIGURATION (TOP VIEW)

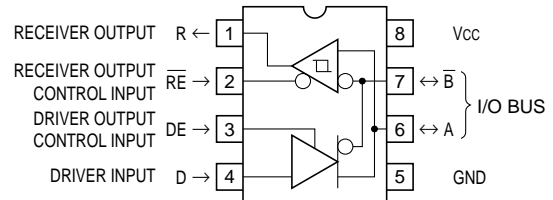

M75176P

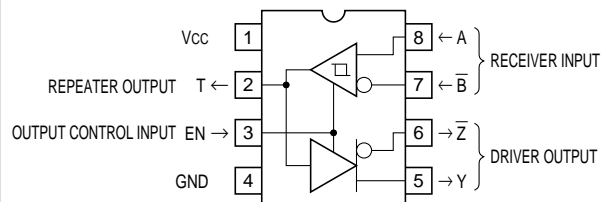

M75177P

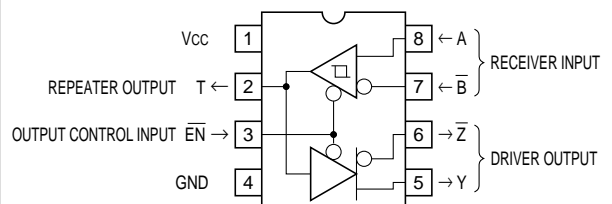

M75178P

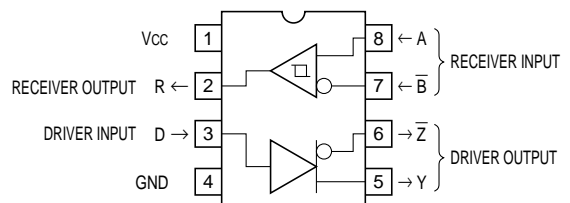

M75179P

Outline 8P4

MITSUBISHI (DIGITAL ASSP)
M75176P, M75177P
M75178P, M75179P

RS-485 TRANSCEIVER

FUNCTION TABLE (Note 1)

(a) M75176P

Driver

INPUTS		OUTPUTS	
D	DE	A	\bar{B}
H	H	H	L
L	H	L	H
X	L	Z	Z

Receiver

INPUTS		OUTPUTS
V_{ID}	$\bar{R}\bar{E}$	R
$V_{ID} > 0.2V$	L	H
$-0.2V < V_{ID} < 0.2V$	L	*
$V_{ID} < -0.2V$	L	L
X	H	Z

(b) M75177P/M75178P

V_{ID}	INPUTS		OUTPUTS		
	EN (M75177P)	$\bar{E}\bar{N}$ (M75178P)	T	Y	\bar{Z}
$V_{ID} > 0.2V$	H	L	H	H	L
$-0.2V < V_{ID} < 0.2V$	H	L	*	*	*
$V_{ID} < -0.2V$	H	L	L	L	H
X	L	H	Z	Z	Z

(c) M75179P

Driver

INPUTS	OUTPUTS	
D	Y	\bar{Z}
H	H	L
L	L	H

Receiver

INPUTS	OUTPUTS
V_{ID}	R
$V_{ID} > 0.2V$	H
$-0.2V < V_{ID} < 0.2V$	*
$V_{ID} < -0.2V$	L

Note 1: V_{ID} : (A applied voltage) – (\bar{B} applied voltage)

X : Either "L" or "H"

* : Output state is not defined.

Z : High impedance state.

ABSOLUTE MAXIMUM RATINGS

Symbol	Parameter	Conditions	Ratings	Unit
VCC	Supply voltage		-0.5 ~ +7	V
VID	Differential input voltage	75177/178/179	-25 ~ +25	V
VI E	Enable input voltage	75176/177/178	-0.5 ~ +5.5	V
Pd	Power dissipation (Note 2)	When Ta=25°C	925	mW
Tstg	Storage temperature		-65 ~ 150	°C

Note 2: When Ta ≥ 25°C, do derating according to the attached thermal derating.

RECOMMENDED OPERATING CONDITIONS

Symbol	Parameter	Limits			Unit	
		Min.	Typ.	Max.		
VCC	Supply voltage	4.75	5	5.25	V	
VI, VIC	Bus pin voltage (each pin voltage, in-phase input voltage)	-7		+12	V	
VID	Differential input voltage	-12		+12	V	
IOH	“H” output current	Driver	0	-60	mA	
		Receiver	0	-400	μA	
IOL	“L” output current	Driver	0	60	mA	
		Receiver	VO L < 0.45V	0		8
			VO L < 0.5V	0		16
Topr	Operating ambient temperature	-20		75	°C	

ELECTRICAL CHARACTERISTICS (Driver) (VCC = 5V ± 5%, Ta = -20 ~ 75°C, unless otherwise noted)

Symbol	Parameter	Test conditions	Limits			Unit	
			Min.	Typ.*	Max.		
VIH	“H” input voltage		2			V	
UIL	“L” input voltage				0.8	V	
VIK	Input clamp voltage	II = -18mA			-1.5	V	
VOD1	Differential output voltage 1	IO = 0mA	1.5		6	V	
VOD2	Differential output voltage 2	RL = 100Ω See Fig. 1.	2 (Note 3)	2.42		V	
		RL = 54Ω See Fig. 1.	1.5	2.18	5		
Δ VOD	Differential output voltage variance width				±0.2	V	
VO L	In-phase output voltage	RL = 54/100Ω See Fig. 1.	-1	2.08	3	V	
Δ VOC	In-phase output voltage variance width				±0.2	V	
IO	Output current	75176	Output disable	VO = 12V	1	mA	
		75177/178/179	VCC = 0V, VO = -7 ~ +12V	VO = -7V	-0.8		
IOZ	Off-state output current	75177/178	VO = -7 ~ +12V		±100	μA	
IIH	“H” input current		VI = 2.4V		20	μA	
II L	“L” input current		VI = 0.4V		-400	μA	
IOS	Output short-circuit current		VO = -7V		-250	mA	
			VO = 0V		-150		
			VO = VCC		250		
			VO = 12V		250		
ICC	Supply voltage	No output load	Output enable		29.5	48	mA
			Output disable		32.5	48	

*: The standard value is given on the condition of VCC = 5V and Ta = 25°C.

Note 3: The standard is 1.9V (min.) when Ta ≤ 0°C.

SWITCHING CHARACTERISTICS (Driver) ($V_{CC} = 5V, T_a = 25^\circ C$)

Symbol	Parameter	Test conditions	Limits			Unit
			Min.	Typ.	Max.	
tDD	Differential output delay time	$R_L = 54\Omega$ $C_L = 50pF$ See Fig. 2.		13	25	ns
tTD	Differential output transition time			11	25	ns
tPLH	Output "L - H" propagation delay time	$R_L = 27\Omega$ $C_L = 50pF$ See Fig. 3.		15	25	ns
tPHL	Output "H - L" propagation delay time			12	25	ns
tPZH	"H" enable time	$R_L = 110\Omega$ $C_L = 50pF$ See Figs. 4 & 5.		23	35	ns
tPZL	"L" enable time			16	35	ns
tPHZ	"H" disable time			11	25	ns
tPLZ	"L" disable time			22	35	ns

ELECTRICAL CHARACTERISTICS (Receiver) ($V_{CC} = 5V \pm 5\%, T_a = -20 \sim 75^\circ C$, unless otherwise noted)

Symbol	Parameter	Test conditions	Limits			Unit
			Min.	Typ.*	Max.	
VTH	High threshold voltage	$V_O = 2.7V, I_O = -0.4mA$			0.2	V
VTL	Low threshold voltage	$V_O = 0.5V, I_O = 16mA$	-0.2			V
$V_{T+} - V_{T-}$	Hysteresis width (Note 4)			50		mV
V _{IK}	Enable input clamp voltage	$I_I = -18mA$			-1.5	V
V _{OH}	"H" output voltage	$V_{ID} = 0.2V, I_{OH} = -0.4mA$	2.7	3.6		V
V _{OL}	"L" output voltage	$V_{ID} = -0.2V$		0.23	0.45	V
		$I_{OL} = 8mA$ $I_{OL} = 16mA$		0.30	0.5	
I _{OZ}	Off-state output current	75176	$V_O = 0.4 \sim 2.4V$		± 20	μA
		75177/178	$V_O = 0.4V$		-400	
			$V_O = 2.4V$		20	
I _I	Line input current	Other input 0V	$V_O = 12V$		1	mA
			$V_O = -7V$		-0.8	
I _{IH}	"H" enable input current	75176/177/178	$V_{IH} = 2.7V$		20	μA
I _{IL}	"L" enable input current	75176	$V_{IL} = 0.4V$		-100	μA
		75177/178			-400	
r _i	Input resistance			12		k Ω
I _{OS}	Output short-circuit current	$V_O = 0V$		-15	-85	mA
I _{CC}	Supply voltage	No output load	Output enable		48	mA
			Output disable		48	

*: The standard value is given on the condition of $V_{CC} = 5V$ and $T_a = 25^\circ C$.

Note 4: The hysteresis width is the difference between positive threshold voltage V_{T+} and negative threshold voltage V_{T-} .

SWITCHING CHARACTERISTICS (Receiver) ($V_{CC} = 5V, T_a = 25^\circ C$)

Symbol	Parameter	Test conditions	Limits			Unit
			Min.	Typ.	Max.	
tPLH	Output "L - H" propagation delay time	$C_L = 15pF$ See Fig. 6.		22	35	ns
tPHL	Output "H - L" propagation delay time			19	35	ns
tPZH	"H" enable time	$C_L = 15pF$ See Fig. 7.		9	20	ns
tPZL	"L" enable time			11	20	ns
tPHZ	"H" disable time			17	35	ns
tPLZ	"L" disable time	$C_L = 15pF$ See Fig. 7.		22	35	ns

TEST CIRCUITS

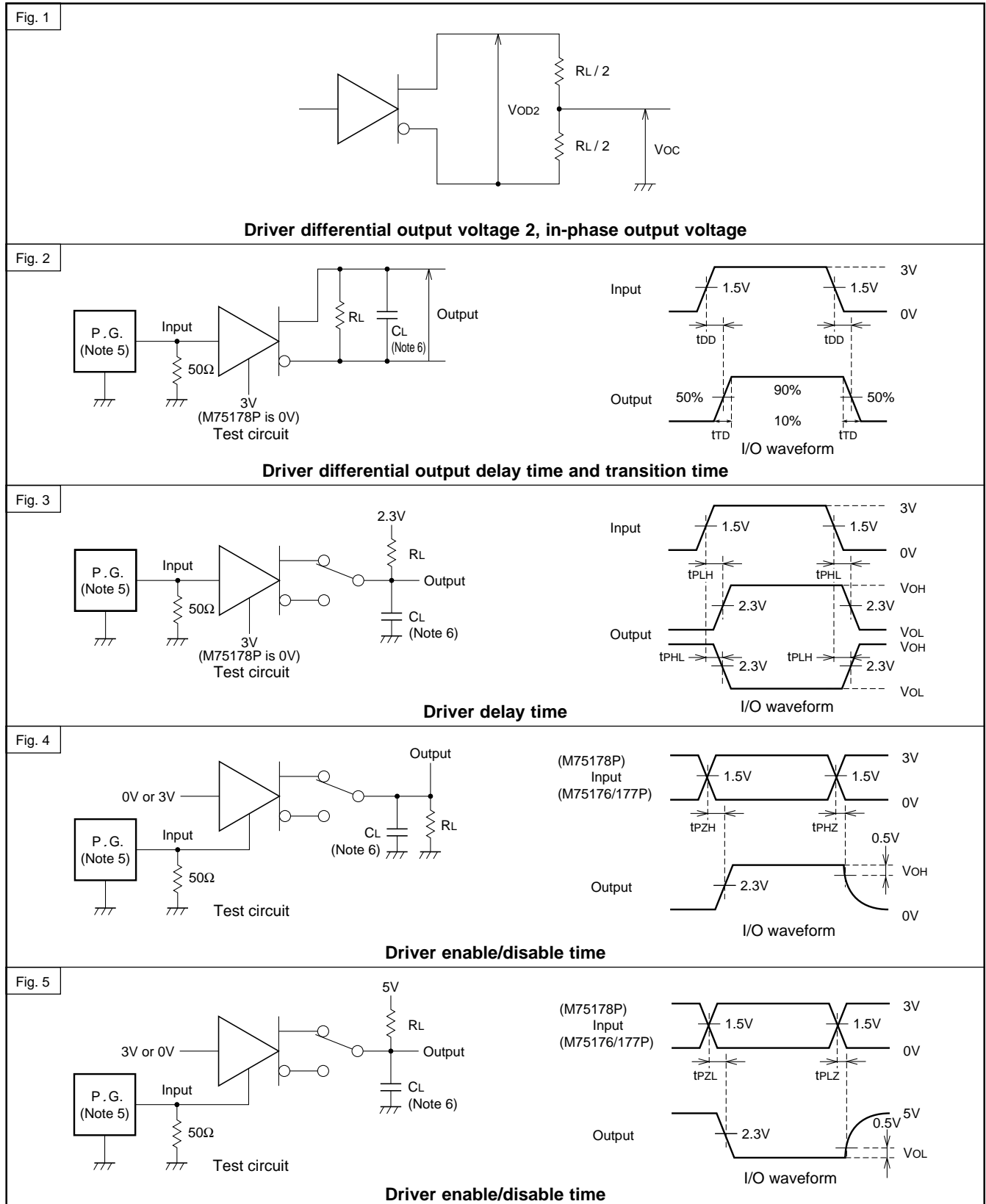

Note 5: The pulse generator is PRR ≤ 1MHz, duty ratio = 50%, tr ≤ 6ns, tr ≤ 6ns, ZOUT = 50Ω.
 Note 6: CL includes jigs and probe capacitance.

Fig. 6

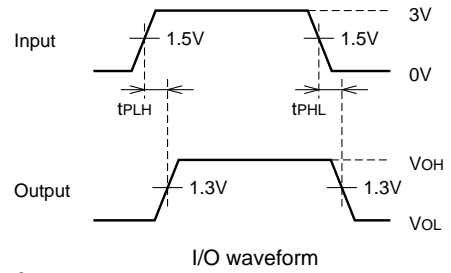
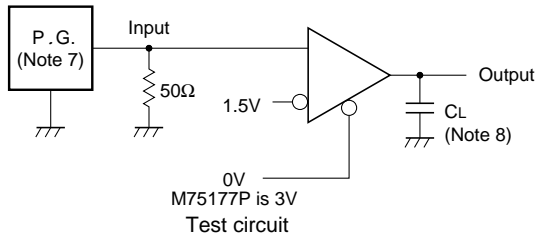

Receiver propagation delay time

Fig. 7

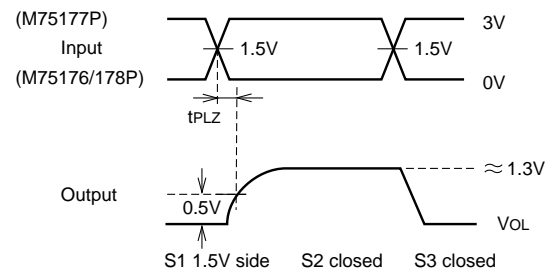
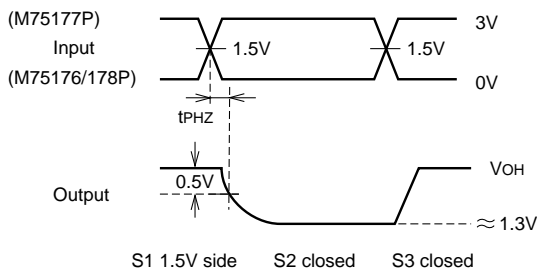
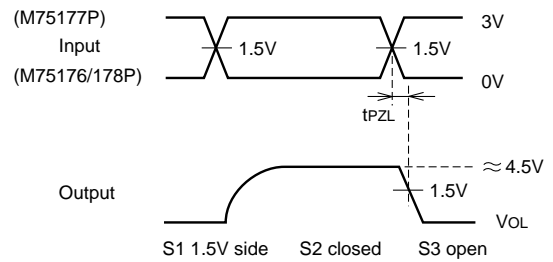
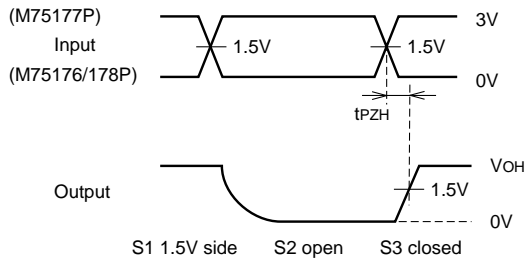
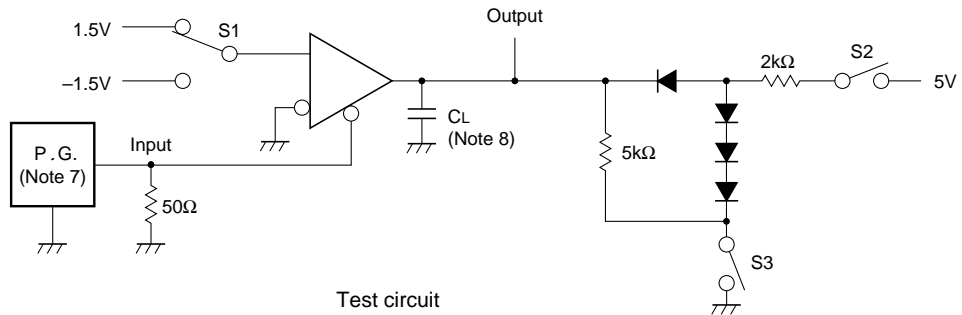

Receiver enable/disable time

Note 7: The pulse generator is PRR ≤ 1MHz, duty ratio = 50%, tr ≤ 6ns, tr ≤ 6ns, ZOUT = 50Ω.
 Note 8: CL includes jigs and probe capacitance.

THERMAL DERATING

THERMAL DERATING CHARACTERISTIC

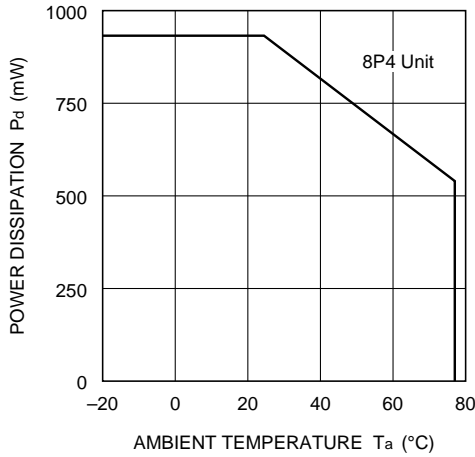

SUPPLY CURRENT - SUPPLY VOLTAGE CHARACTERISTIC

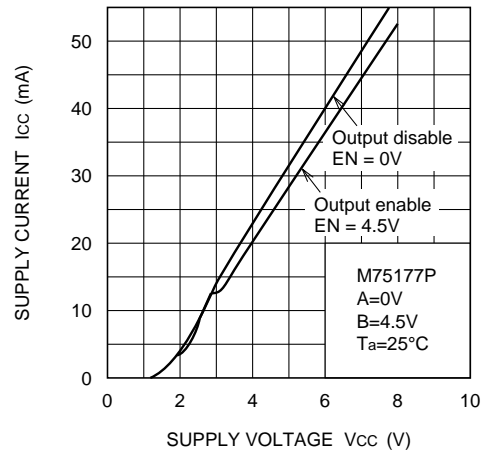

DRIVER
"H" OUTPUT VOLTAGE
"L" OUTPUT VOLTAGE - OUTPUT CURRENT CHARACTERISTIC

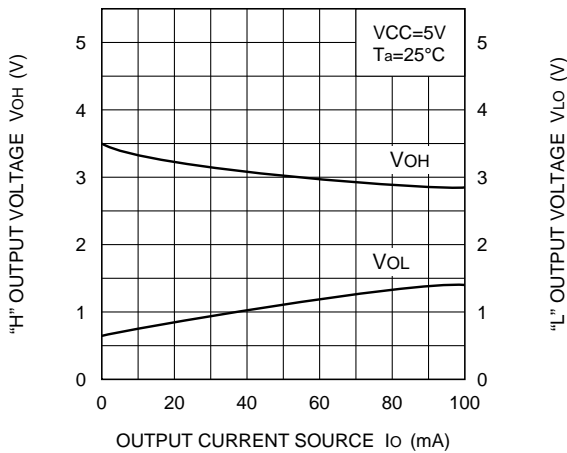

DIFFERENTIAL OUTPUT VOLTAGE
IN-PHASE OUTPUT VOLTAGE - OUTPUT CURRENT CHARACTERISTIC

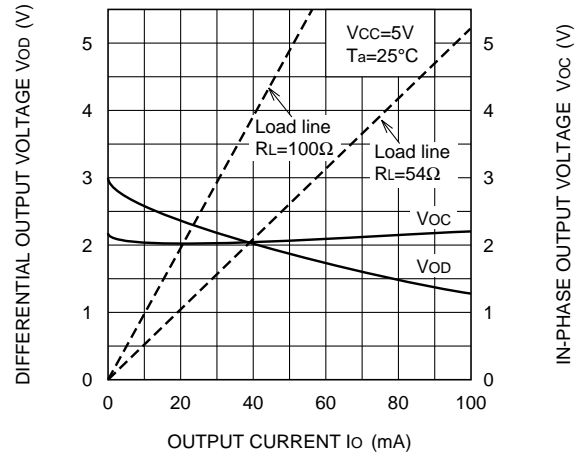

SWITCHING CHARACTERISTIC

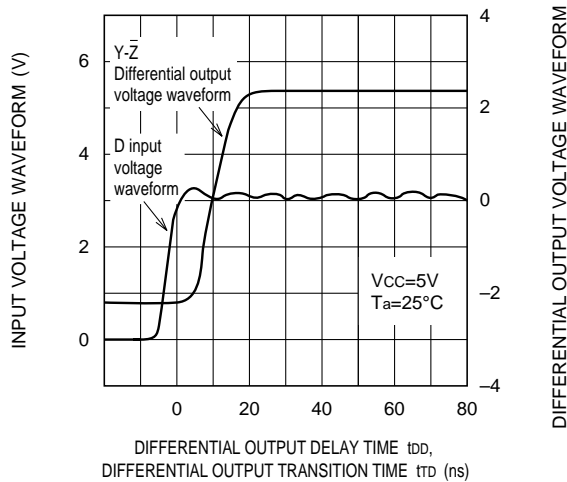

SWITCHING CHARACTERISTIC

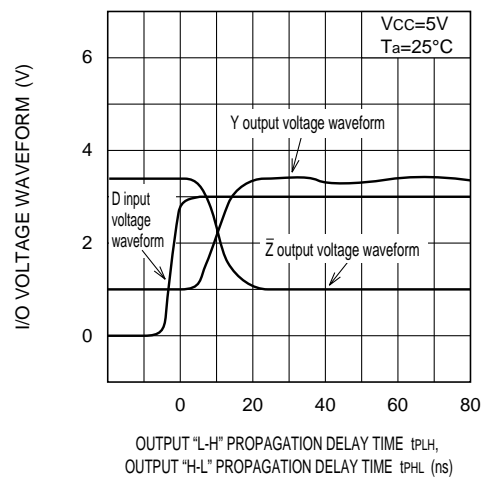

MITSUBISHI <DIGITAL ASSP>
M75176P, M75177P
M75178P, M75179P

RS-485 TRANSCEIVER

RECEIVER
 I/O TRANSMISSION CHARACTERISTIC (A→R)

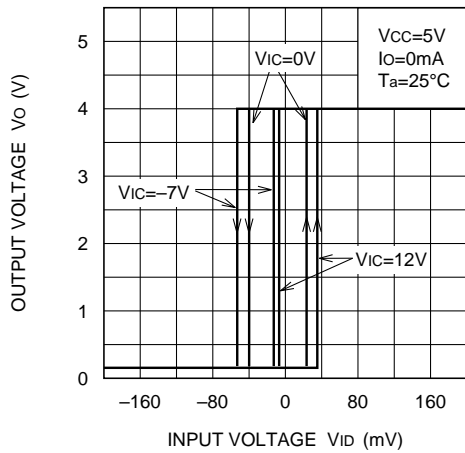

INPUT CURRENT - INPUT VOLTAGE CHARACTERISTIC (A)

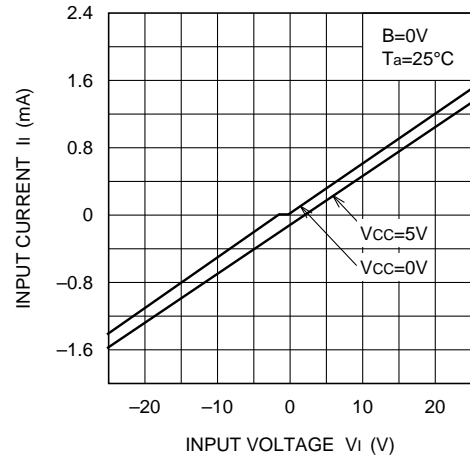

"H" OUTPUT VOLTAGE - "H" OUTPUT CURRENT CHARACTERISTIC

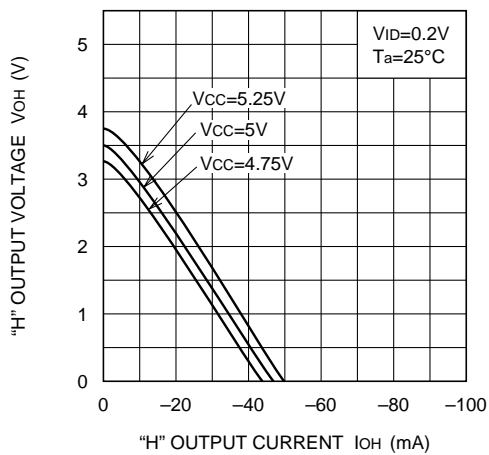

"L" OUTPUT VOLTAGE - "L" OUTPUT CURRENT CHARACTERISTIC

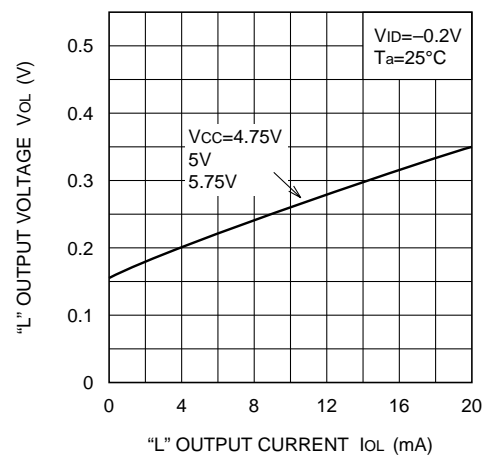

SWITCHING CHARACTERISTIC

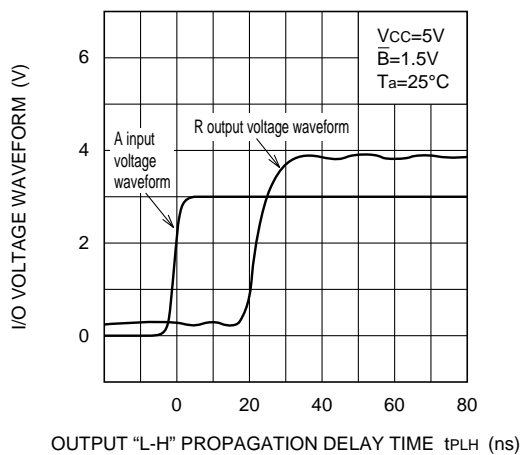

SWITCHING CHARACTERISTIC

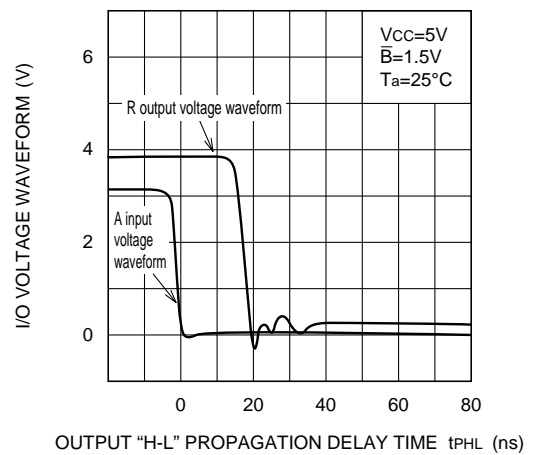

APPLICATION EXAMPLE

