

MH16V725BATJ -5, -6

HYPER PAGE MODE 1207959552 - BIT (16777216 - WORD BY 72 - BIT) DYNAMIC RAM

DESCRIPTION

The MH16V725BATJ is 16777216-word x 72-bit dynamic ram module. This consist of eighteen industry standard 16M x 4 dynamic RAMs in TSOP and three industry standard input buffer in TSSOP.

The mounting of TSOP on a card edge dual in-line package provides any application where high densities and large of quantities memory are required.

This is a socket-type memory module ,suitable for easy interchange or addition of module.

FEATURES

Type name	/RAS access time (max.ns)	/CAS access time (max.ns)	Address access time (max.ns)	/OE access time (max.ns)	Cycle time (min.ns)	Power dissipation (typ.W)
MH16V725BATJ-5	50	18	30	18	84	5.50
MH16V725BATJ-6	60	20	35	20	104	4.60

- Utilizes industry standard 16M x 4 RAMs TSOP and industry standard input buffer in TSSOP
- 168-pin (84-pin dual in-line package)
- Single 3.3V(+/-0.3V) supply operation
- Low stand-by power dissipation 121mW(Max)
- Low operation power dissipation
 MH16V725BATJ -5 6.58W(Max)
 MH16V725BATJ -6 5.94W(Max)
- All input,output LVTTTL compatible
- Includes(0.22uF x 20) decoupling capacitors
- 4096 refresh cycle every 64ms (A0~A12)
- JEDEC standard pin configuration & Buffered PD pin
 Buffered input except /RAS and DQ
- Gold plating contact pads

APPLICATION

Main memory unit for computers , Microcomputer memory

PD&ID TABLE

	PD1	PD2	PD3	PD4	PD5	PD6	PD7	PD8	ID0	ID1
- 5	1	1	1	1	1	0	0	0	0	0
- 6	1	1	1	1	1	1	1	0	0	0

1 = NC , 0 = drive to VOL

PD pin . . . buffered. When /PDE is low, PD information can be read

ID pin . . . non-buffered

PIN CONFIGURATION

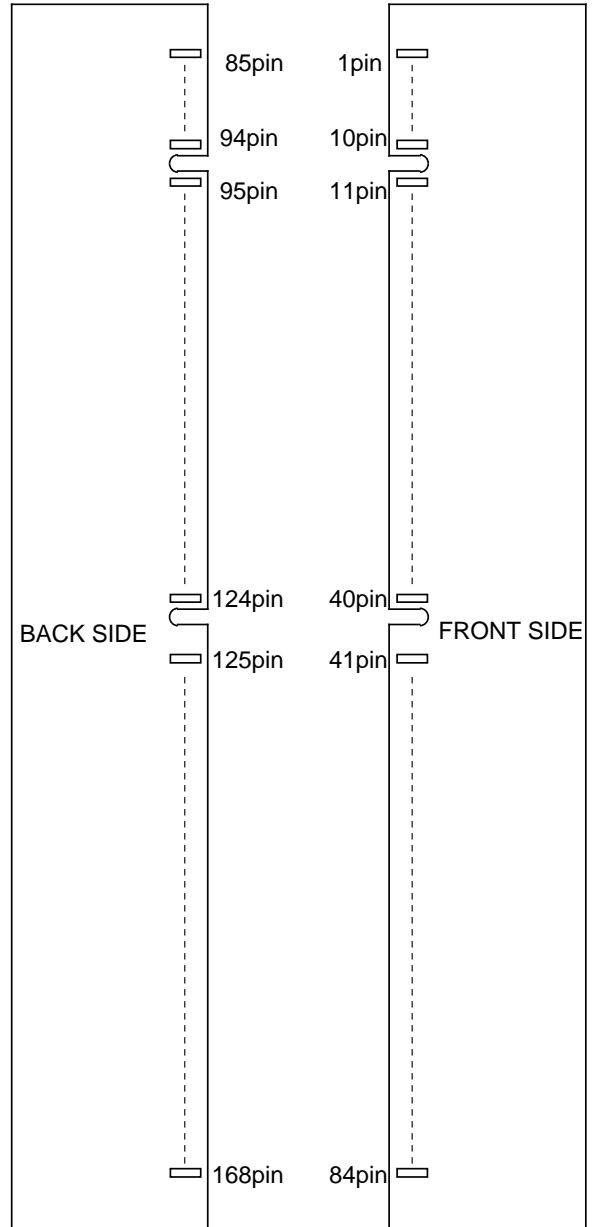

MH16V725BATJ -5, -6

HYPER PAGE MODE 1207959552 - BIT (16777216 - WORD BY 72 - BIT) DYNAMIC RAM

PIN CONFIGURATION

Pin No.	Pin Name	Pin No.	Pin Name	Pin No.	Pin Name	Pin No.	Pin Name
1	Vss	43	Vss	85	Vss	127	Vss
2	DQ0	44	/OE2	86	DQ36	128	RFU
3	DQ1	45	/RAS2	87	DQ37	129	Reserved
4	DQ2	46	/CAS4	88	DQ38	130	Reserved
5	DQ3	47	Reserved	89	DQ39	131	Reserved
6	Vcc	48	/WE2	90	Vcc	132	/PDE
7	DQ4	49	Vcc	91	DQ40	133	Vcc
8	DQ5	50	Reserved	92	DQ41	134	Reserved
9	DQ6	51	Reserved	93	DQ42	135	Reserved
10	DQ7	52	DQ18	94	DQ43	136	DQ54
11	DQ8	53	DQ19	95	DQ44	137	DQ55
12	Vss	54	Vss	96	Vss	138	Vss
13	DQ9	55	DQ20	97	DQ45	139	DQ56
14	DQ10	56	DQ21	98	DQ46	140	DQ57
15	DQ11	57	DQ22	99	DQ47	141	DQ58
16	DQ12	58	DQ23	100	DQ48	142	DQ59
17	DQ13	59	Vcc	101	DQ49	143	Vcc
18	Vcc	60	DQ24	102	Vcc	144	DQ60
19	DQ14	61	RFU	103	DQ50	145	RFU
20	DQ15	62	RFU	104	DQ51	146	RFU
21	DQ16	63	RFU	105	DQ52	147	RFU
22	DQ17	64	RFU	106	DQ53	148	RFU
23	Vss	65	DQ25	107	Vss	149	DQ61
24	Reserved	66	DQ26	108	Reserved	150	DQ62
25	Reserved	67	DQ27	109	Reserved	151	DQ63
26	Vcc	68	Vss	110	Vcc	152	Vss
27	/WE0	69	DQ28	111	RFU	153	DQ64
28	/CAS0	70	DQ29	112	Reserved	154	DQ65
29	Reserved	71	DQ30	113	Reserved	155	DQ66
30	/RAS0	72	DQ31	114	Reserved	156	DQ67
31	/OE0	73	Vcc	115	RFU	157	Vcc
32	Vss	74	DQ32	116	Vss	158	DQ68
33	A0	75	DQ33	117	A1	159	DQ69
34	A2	76	DQ34	118	A3	160	DQ70
35	A4	77	DQ35	119	A5	161	DQ71
36	A6	78	Vss	120	A7	162	Vss
37	A8	79	PD1	121	A9	163	PD2
38	A10	80	PD3	122	A11	164	PD4
39	A12	81	PD5	123	Reserved	165	PD6
40	Vcc	82	PD7	124	Vcc	166	PD8
41	RFU	83	ID0	125	RFU	167	ID1
42	RFU	84	Vcc	126	B0	168	Vcc

Reserved: Reserved use
RFU: Reserved for future use

MH16V725BATJ -5, -6

HYPER PAGE MODE 1207959552 - BIT (16777216 - WORD BY 72 - BIT) DYNAMIC RAM

BLOCK DIAGRAM

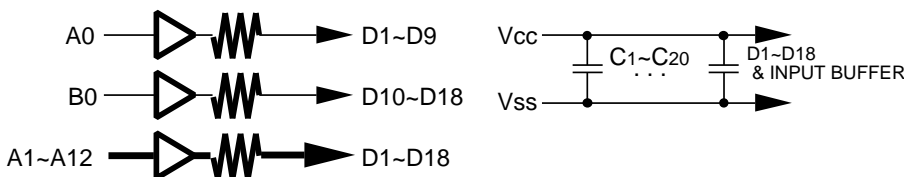
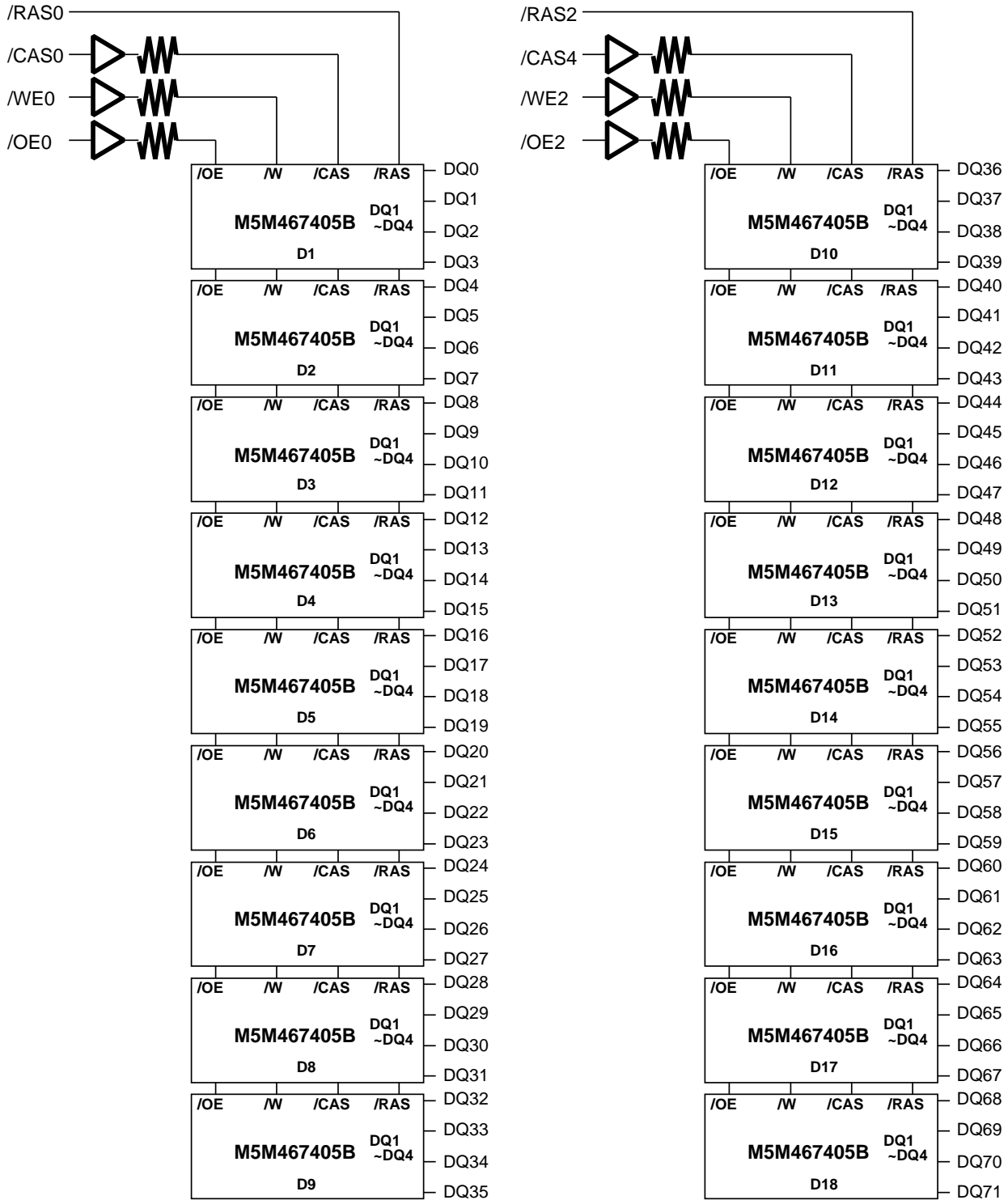

PIN NAME	FUNCTION
/RAS0, /RAS2	ROW ADDRESS STROBE INPUT
/CAS0, /CAS2	COLUMN ADDRESS STROBE INPUT
/WE0, /WE2	WRITE CONTROL INPUT
/OE0, /OE2	OUTPUT ENABLE INPUT
A0~A12, B0	ADDRESS INPUT
DQ0~DQ71	DATA I/O
Vcc	POWER SUPPLY
Vss	GROUND

MH16V725BATJ -5, -6

HYPER PAGE MODE 1207959552 - BIT (16777216 - WORD BY 72 - BIT) DYNAMIC RAM

FUNCTION

The MH16V725BATJ provide, in addition to normal read, write, and read-modify-write operations,

a number of other functions, e.g., Hyper page mode, /CAS before /RAS refresh, and delayed-write. The input conditions for each are shown in Table 1.

Table 1 Input conditions for each mode

Operation	Inputs						Input/Output		Refresh	Remark
	/RAS	/CAS	/W	/OE	Row address	Column address	Input	Output		
Read	ACT	ACT	NAC	ACT	APD	APD	OPN	VLD	NO	Hyper page mode identical
Write (Early write)	ACT	ACT	ACT	DNC	APD	APD	VLD	OPN	NO	
Write (Delayed write)	ACT	ACT	ACT	DNC	APD	APD	VLD	IVD	NO	
Read-modify-write	ACT	ACT	ACT	ACT	APD	APD	VLD	VLD	NO	
Hidden refresh	ACT	ACT	DNC	ACT	DNC	DNC	OPN	VLD	YES	
/CAS before /RAS refresh	ACT	ACT	NAC	DNC	DNC	DNC	DNC	OPN	YES	
Standby	NAC	DNC	DNC	DNC	DNC	DNC	DNC	OPN	NO	

Note : ACT : active, NAC : nonactive, DNC : don't care, VLD : valid, IVD : Invalid, APD : applied, OPN : open

MH16V725BATJ -5, -6

HYPER PAGE MODE 1207959552 - BIT (16777216 - WORD BY 72 - BIT) DYNAMIC RAM

ABSOLUTE MAXIMUM RATINGS

Symbol	Parameter	Conditions	Ratings	Unit
Vcc	Supply voltage	With respect to Vss	-0.5~4.6	V
VI	Input voltage		-0.5~ 4.6	
VO	Output voltage		-0.5~ 4.6	
IO	Output current		50	mA
Pd	Power dissipation	Ta=25°C	21.6	W
Topr	Operating temperature		0~70	°C
Tstg	Storage temperature		-40~100	°C

RECOMMENDED OPERATING CONDITIONS (Ta=0~70°C, unless otherwise noted) (Note 1)

Symbol	Parameter	Limits			Unit
		Min	Nom	Max	
Vcc	Supply voltage	3.0	3.3	3.6	V
Vss	Supply voltage	0	0	0	V
VIH	High-level input voltage, all inputs	2.0		Vcc+0.3	V
VIL	Low-level input voltage	-0.3		0.8	V

Note 1 : All voltage values are with respect to Vss

ELECTRICAL CHARACTERISTICS (Ta=0~70°C, Vcc=3.3V+/-0.3V, Vss=0V, unless otherwise noted) (Note 2)

Symbol	Parameter	Test conditions	Limits			Unit
			Min	Typ	Max	
VOH	High-level output voltage	IOH=-2mA	2.4		Vcc	V
VOL	Low-level output voltage	IOL=2mA	0		0.4	V
IOZ	Off-state output current	Q floating 0V VOUT Vcc	-10		10	µA
II	Input current (except /RAS)	0V VIN Vcc+0.3, Other input pins=0V	-10		10	µA
II (RAS)	Input current (/RAS)	0V VIN Vcc+0.3, Other input pins=0V	-90		90	µA
ICC1 (AV)	Average supply current from Vcc operating (Note 3,4,5)	-5 /RAS, /CAS cycling tRC=tWC=min. output open			1820	mA
			-6		1640	
ICC2	Supply current from Vcc, stand-by	/RAS=/CAS =VIH, output open			38	mA
		/RAS=/CAS=WE Vcc -0.2, output open			29	
ICC4(AV)	Average supply current from Vcc Hyper-Page-Mode (Note 3,4,5)	-5 /RAS=VIL, /CAS cycling tPC=min. output open			1820	mA
			-6		1640	
ICC6(AV)	Average supply current from Vcc /CAS before /RAS refresh mode (Note 3)	-5 /CAS before /RAS refresh cycling tRC=min. output open			2360	mA
			-6		2180	

Note 2: Current flowing into an IC is positive, out is negative.

3: Icc1 (AV), Icc3 (AV), Icc4 (AV) and Icc6 (AV) are dependent on cycle rate. Maximum current is measured at the fastest cycle rate.

4: Icc1 (AV) and Icc4 (AV) are dependent on output loading. Specified values are obtained with the output open.

5: Under condition of column address being changed once or less while /RAS=VIL and /CAS=VIH

CAPACITANCE (Ta = 0~70°C, Vcc = 3.3V+/-0.3V, Vss = 0V, unless otherwise noted)

Symbol	Parameter	Test conditions	Limits			Unit
			Min	Typ	Max	
CI (/RAS)	Input capacitance, /RAS input	VI=Vss			80	pF
CI	Input capacitance, except /RAS input	f=1MHZ			15	pF
C(DQ)	Input/Output capacitance, DATA	Vi=25mVrms			18	pF

MH16V725BATJ -5, -6

HYPER PAGE MODE 1207959552 - BIT (16777216 - WORD BY 72 - BIT) DYNAMIC RAM

SWITCHING CHARACTERISTICS (Ta=0~70°C, Vcc=3.3V+/-0.3V, Vss=0V, unless otherwise noted, see notes 6,14,15)

Symbol	Parameter	Limits				Unit
		-5		-6		
		Min	Max	Min	Max	
tCAC	Access time from /CAS (Note 7,8)		18		20	ns
tRAC	Access time from /RAS (Note 7,9)		50		60	ns
tAA	Column address access time (Note 7,10)		30		35	ns
tCPA	Access time from /CAS precharge (Note 7,11)		33		38	ns
tOEA	Access time from /OE (Note 7)		18		20	ns
tOHC	Output hold time /CAS high	10		10		ns
tOHR	Output hold time /RAS high (Note 13)	5		5		ns
tCLZ	Output low impedance time from /CAS low (Note 7)	10		10		ns
tOEZ	Output disable time after /OE high (Note 12)		18		20	ns
tWEZ	Output disable time after /WE high (Note 12)		18		20	ns
tOFF	Output disable time after /CAS high (Note 12,13)		18		20	ns
tREZ	Output disable time after /RAS high (Note 12,13)		13		15	ns

Note 6: An initial pause of 500us is required after power-up followed by a minimum of eight initialization cycles (any combination of cycles containing a /RAS-Only refresh or /CAS before /RAS refresh).

Note the /RAS may be cycled during the initial pause. And any 8 /RAS or /RAS /CAS cycles are required after prolonged periods (greater than 64 ms) of /RAS inactivity before proper device operation is achieved.

7: Measured with a load circuit equivalent to 1TTL loads and 50pF, VOH=2.4V (IOH=-2mA) and VOL=0.4V (IOL=-2mA).

The reference levels for measuring of output signals are 2.0V (VOH) and 0.8V (VOL).

8: Assumes that tRCD tRCD(max), tASC tASC(max) and tCP tCP(max).

9: Assumes that tRCD tRCD(max) and tRAD tRAD(max). If tRCD or tRAD is greater than the maximum recommended value shown in this table, tRAC will increase by amount that tRCD exceeds the value shown.

10: Assumes that tRAD tRAD(max) and tASC tASC(max).

11: Assumes that tCP tCP(max) and tASC tASC(max).

12: tOEZ (max), tWEZ(max), tOFF(max) and tREZ(max) defines the time at which the output achieves the high impedance state (IOUT I+/-10uA) and is not reference to VOH(min) or VOL(max).

13: Output is disable after both /RAS and /CAS go to high

TIMING REQUIREMENTS (For Read, Write, Read-Modify-Write, Refresh, and Hyper-Page Mode Cycles)

(Ta=0~70°C, Vcc=3.3V+/-0.3V, Vss=0V, unless otherwise noted, see notes 14,15)

Symbol	Parameter	Limits				Unit
		-5		-6		
		Min	Max	Min	Max	
tREF	Refresh cycle time		64		64	ms
tRP	/RAS high pulse width	30		40		ns
tRCD	Delay time, /RAS low to /CAS low (Note16)	9	32	9	40	ns
tCRP	Delay time, /CAS high to /RAS low	10		10		ns
tRPC	Delay time, /RAS high to /CAS low	0		0		ns
tCPN	/CAS high pulse width	8		10		ns
tRAD	Column address delay time from /RAS low (Note17)	5	20	7	25	ns
tASR	Row address setup time before /RAS low	5		5		ns
tASC	Column address setup time before /CAS low (Note18)	0	10	0	13	ns
tRAH	Row address hold time after /RAS low	3		5		ns
tCAH	Column address hold time after /CAS low	8		10		ns
tDZC	Delay time, data to /CAS low (Note19)	0		0		ns
tDZO	Delay time, data to /OE low (Note19)	0		0		ns
tRDD	Delay time, /RAS high to data (Note20)	13		15		ns
tCDD	Delay time, /CAS high to data (Note20)	18		20		ns
tODD	Delay time, /OE high to data (Note20)	18		20		ns
tT	Transition time (Note21)	1	50	1	50	ns

Note 14: The timing requirements are assumed tT =2ns.

15: VIH(min) and VIL(max) are reference levels for measuring timing of input signals.

16: tRCD(max) is specified as a reference point only. If tRCD is less than tRCD(max), access time is tRAC. If tRCD is greater than tRCD(max), access time is controlled exclusively by tCAC or tAA.

17: tRAD(max) is specified as a reference point only. If tRAD tRAD(max) and tASC tASC(max), access time is controlled exclusively by tAA.

18: tASC(max) is specified as a reference point only. If tRCD tRCD(max) and tASC tASC(max), access time is controlled exclusively by tCAC.

19: Either tDZC or tDZO must be satisfied.

20: Either tRDD or tCDD or tODD must be satisfied.

21: tT is measured between VIH(min) and VIL(max).

MH16V725BATJ -5, -6

HYPER PAGE MODE 1207959552 - BIT (16777216 - WORD BY 72 - BIT) DYNAMIC RAM

Read and Refresh Cycles

Symbol	Parameter	Limits				Unit
		-5		-6		
		Min	Max	Min	Max	
tRC	Read cycle time	84		104		ns
tRAS	/RAS iow pulse width	50	10000	60	10000	ns
tCAS	/CAS iow pulse width	8	10000	10	10000	ns
tCSH	/CAS hold time after /RAS iow	30		43		ns
tRSH	/RAS hold time after /CAS iow	18		20		ns
tRCS	Read Setup time after /CAS high	0		0		ns
tRCH	Read hold time after /CAS iow (Note 22)	0		0		ns
tRRH	Read hold time after /RAS iow (Note 22)	0		0		ns
tRAL	Column address to /RAS hold time	30		35		ns
tCAL	Column address to /CAS hold time	13		18		ns
tORH	/RAS hold time after /OE iow	18		20		ns
tOCH	/CAS hold time after /OE iow	13		15		ns

Note 22: Either tRCH or tRRH must be satisfied for a read cycle.

Write Cycle (Early Write and Delayed Write)

Symbol	Parameter	Limits				Unit
		-5		-6		
		Min	Max	Min	Max	
tWC	Write cycle time	84		104		ns
tRAS	/RAS iow pulse width	50	10000	60	10000	ns
tCAS	/CAS iow pulse width	8	10000	10	10000	ns
tCSH	/CAS hold time after /RAS iow	30		35		ns
tRSH	/RAS hold time after /CAS iow	18		20		ns
tWCS	Write setup time before /CAS low (Note 24)	0		0		ns
tWCH	Write hold time after /CAS iow	8		10		ns
tCWL	/CAS hold time after /W iow	8		10		ns
tRWL	/RAS hold time after W iow	13		15		ns
tWP	Write pulse width	8		10		ns
tDS	Data setup time before /CAS iow or W iow	-5		-5		ns
tDH	Data hold time after /CAS iow or W iow	13		15		ns

Read-Write and Read-Modify-Write Cycles

Symbol	Parameter	Limits				Unit
		-5		-6		
		Min	Max	Min	Max	
tRWC	Read write/read modify write cycle time (Note23)	109		133		ns
tRAS	RAS iow pulse width	75	10000	89	10000	ns
tCAS	CAS iow pulse width	38	10000	44	10000	ns
tCSH	CAS hold time after RAS low	65		77		ns
tRSH	RAS hold time after CAS low	43		49		ns
tRCS	Read setup time before CAS low	0		0		ns
tCWD	Delay time, CAS iow to W iow (Note24)	28		32		ns
tRWD	Delay time, RAS iow to W iow (Note24)	60		72		ns
tAWD	Delay time, address to W iow (Note24)	40		47		ns
tOEH	OE hold time after W iow	13		15		ns

Note 23: tRWC is specified as $tRWC(\min)=tRAC(\max)+tODD(\min)+tRWL(\min)+tRP(\min)+4tT$.

24: tWCS, tCWD, tRWD, tAWD and tCPWD are specified as reference points only. If tWCS tWCS(min) the cycle is an early write cycle and the DQ pins will remain high impedance throughout the entire cycle. If tCWD tCWD(min), tRWD tRWD (min), tAWD tAWD(min) and tCPWD tCPWD(min) (for Hyper page mode cycle only), the cycle is a read-modify-write cycle and the DQ will contain the data read from the selected address. If neither of the above condition (delayed write) of the DQ (at access time and until /CAS or /OE goes back to VIH) is indeterminate.

MH16V725BATJ -5, -6

HYPER PAGE MODE 1207959552 - BIT (16777216 - WORD BY 72 - BIT) DYNAMIC RAM

**Hyper Page Mode Cycle (Read, Early Write, Read -Write, Read-Modify-Write Cycle,
Read Write Mix Cycle,Hi-Z control by /OE or /WE) (Note 25)**

Symbol	Parameter	Limits				Unit
		-5		-6		
		Min	Max	Min	Max	
tHPC	Hyper page mode read/write cycle time	20		25		ns
tHPRWC	Hyper page mode read write/read modify write cycle time	55		66		ns
tRAS	/RAS low pulse width for read write cycle (Note26)	65	100000	77	100000	ns
tCP	/CAS high pulse width (Note27)	8	15	10	18	ns
tCPRH	/RAS hold time after /CAS precharge	33		38		ns
tCPWD	Delay time, /CAS precharge to W low (Note24)	43		50		ns
tCHOL	Hold time to maintain the data Hi-Z until /CAS access	7		7		ns
tOEPE	/OE Pulse Width (Hi-Z control)	7		7		ns
tWPE	/W Pulse Width (Hi-Z control)	7		7		ns
tHCWD	Delay time, /CAS low to /W low after read	28		32		ns
tHAWD	Delay time, Address to /W low after read	40		47		ns
tHPWD	Delay time, /CAS precharge to /W low after read	43		50		ns
tHCOD	Delay time, /CAS low to /OE high after read	13		15		ns
tHAOD	Delay time, Address to /OE high after read	25		30		ns
tHPOD	Delay time, /CAS precharge to /OE high after read	28		33		ns

Note 25: All previously specified timing requirements and switching characteristics are applicable to their respective fast page mode cycle.

26: tRAS(min) is specified as two cycles of CAS input are performed.

27: tCP(max) is specified as a reference point only.

/CAS before /RAS Refresh Cycle (Note 28)

Symbol	Parameter	Limits				Unit
		-5		-6		
		Min	Max	Min	Max	
tCSR	/CAS setup time before /RAS low	10		10		ns
tCHR	/CAS hold time after /RAS low	5		5		ns
tRSR	Read setup time before /RAS low	15		15		ns
tRHR	Read hold time after /RAS low	5		5		ns

Note 28: Eight or more /CAS before /RAS cycles instead of eight /RAS cycles are necessary for proper operation of /CAS before /RAS refresh mode.

MH16V725BATJ -5, -6

HYPER PAGE MODE 1207959552 - BIT (16777216 - WORD BY 72 - BIT) DYNAMIC RAM

Timing Diagrams (Note 29) Read Cycle

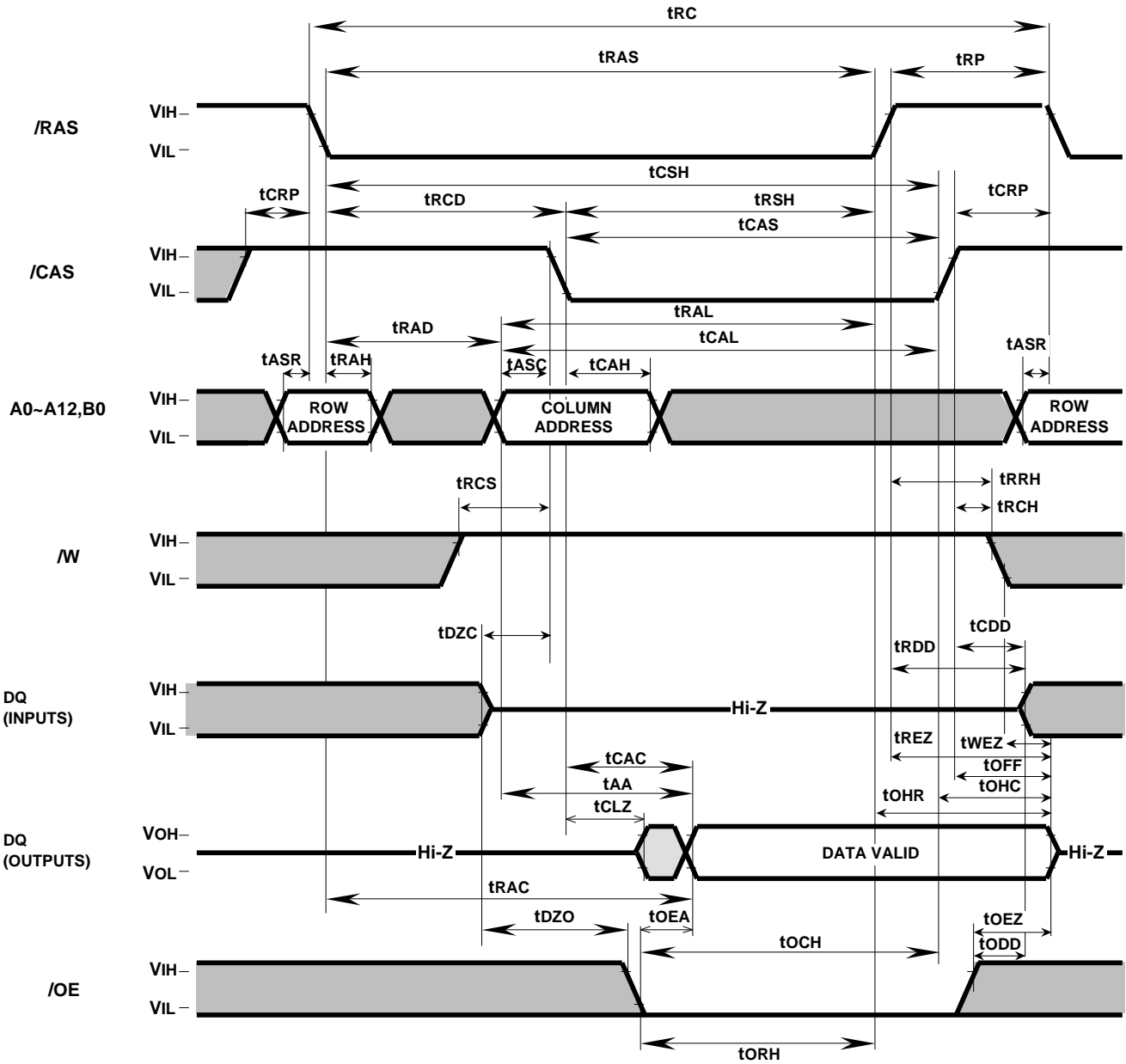

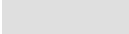
Note 29  Indicates the don't care input.
 $V_{IH(min)}$ V_{IN} $V_{IH(max)}$ or $V_{IL(min)}$ V_{IN} $V_{IL(max)}$
 Indicates the invalid output.

MH16V725BATJ -5, -6

HYPER PAGE MODE 1207959552 - BIT (16777216 - WORD BY 72 - BIT) DYNAMIC RAM

Early Write Cycle

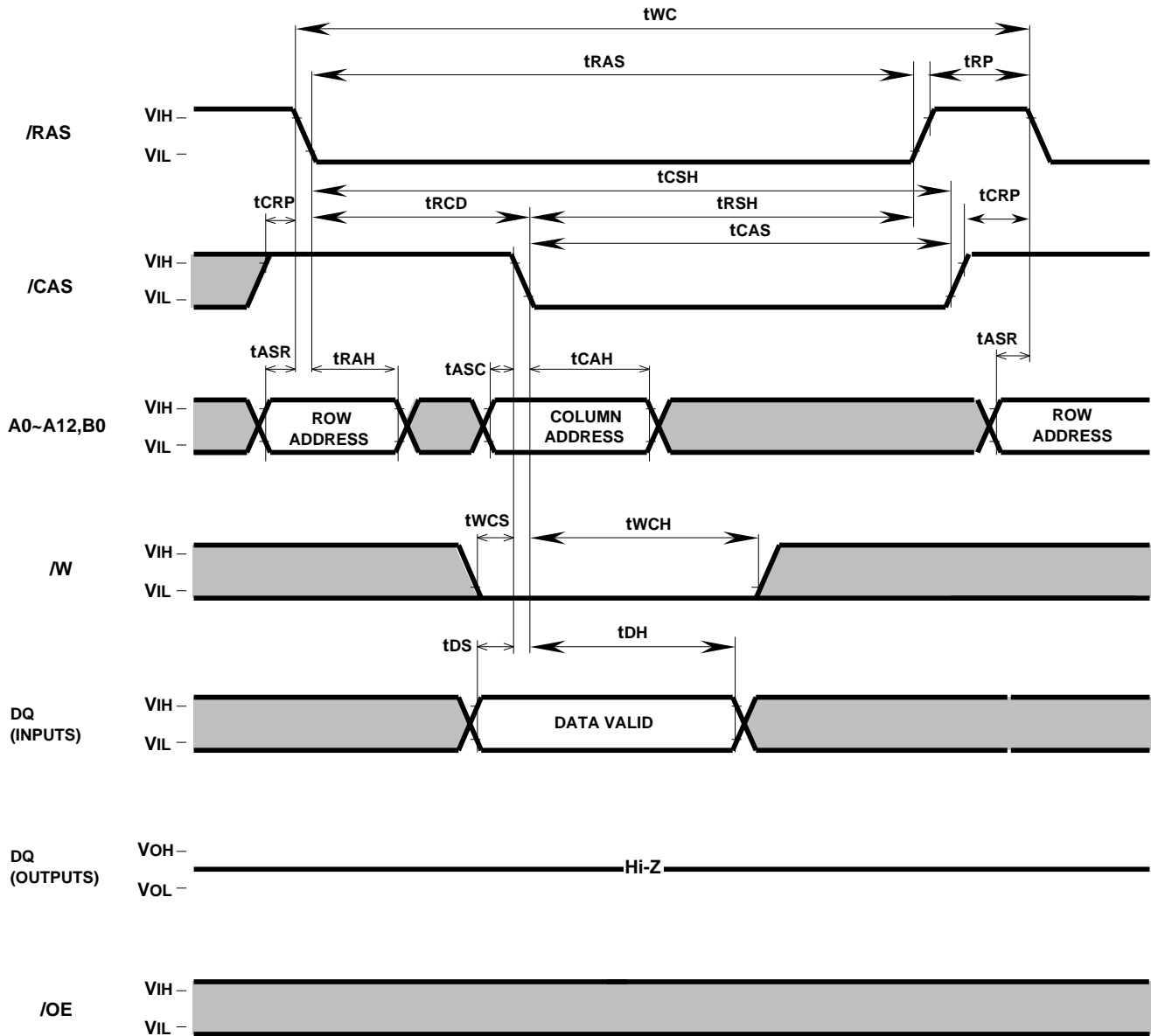

MH16V725BATJ -5, -6

HYPER PAGE MODE 1207959552 - BIT (16777216 - WORD BY 72 - BIT) DYNAMIC RAM

Delayed Write Cycle

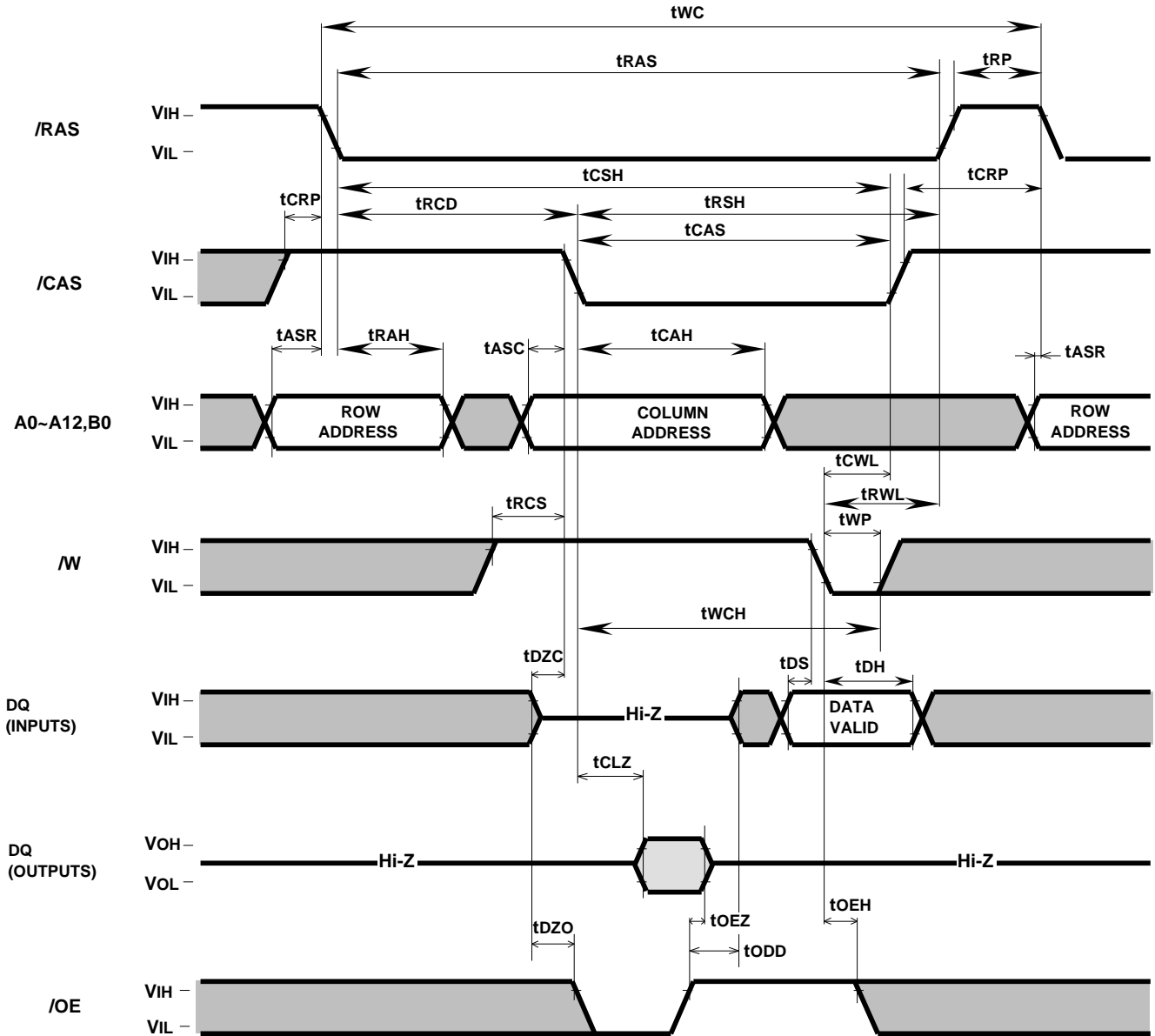

MH16V725BATJ -5, -6

HYPER PAGE MODE 1207959552 - BIT (16777216 - WORD BY 72 - BIT) DYNAMIC RAM

Read-Write, Read-Modify-Write Cycle

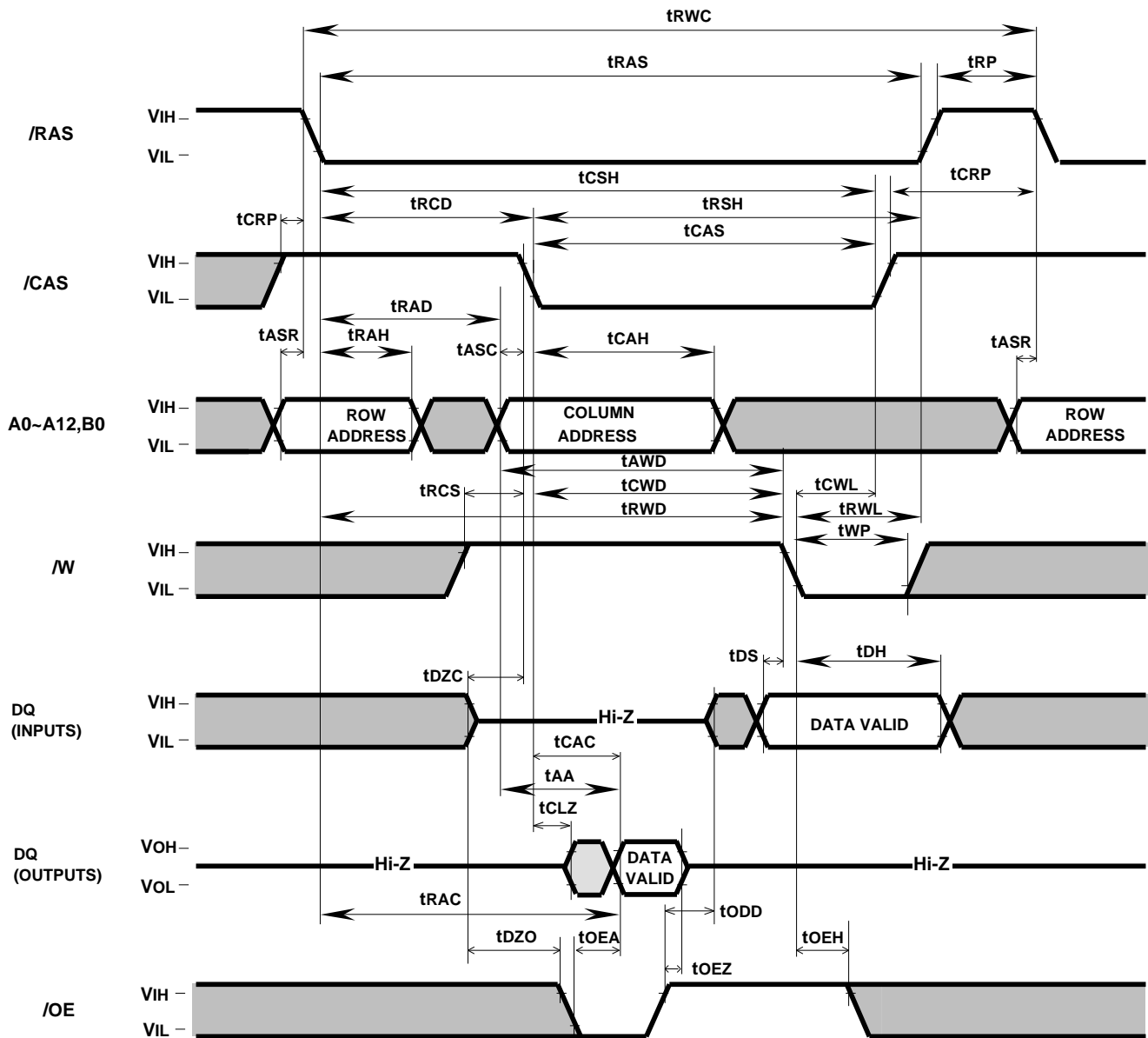

MH16V725BATJ -5, -6

HYPER PAGE MODE 1207959552 - BIT (16777216 - WORD BY 72 - BIT) DYNAMIC RAM

Hyper Page Mode Read Cycle

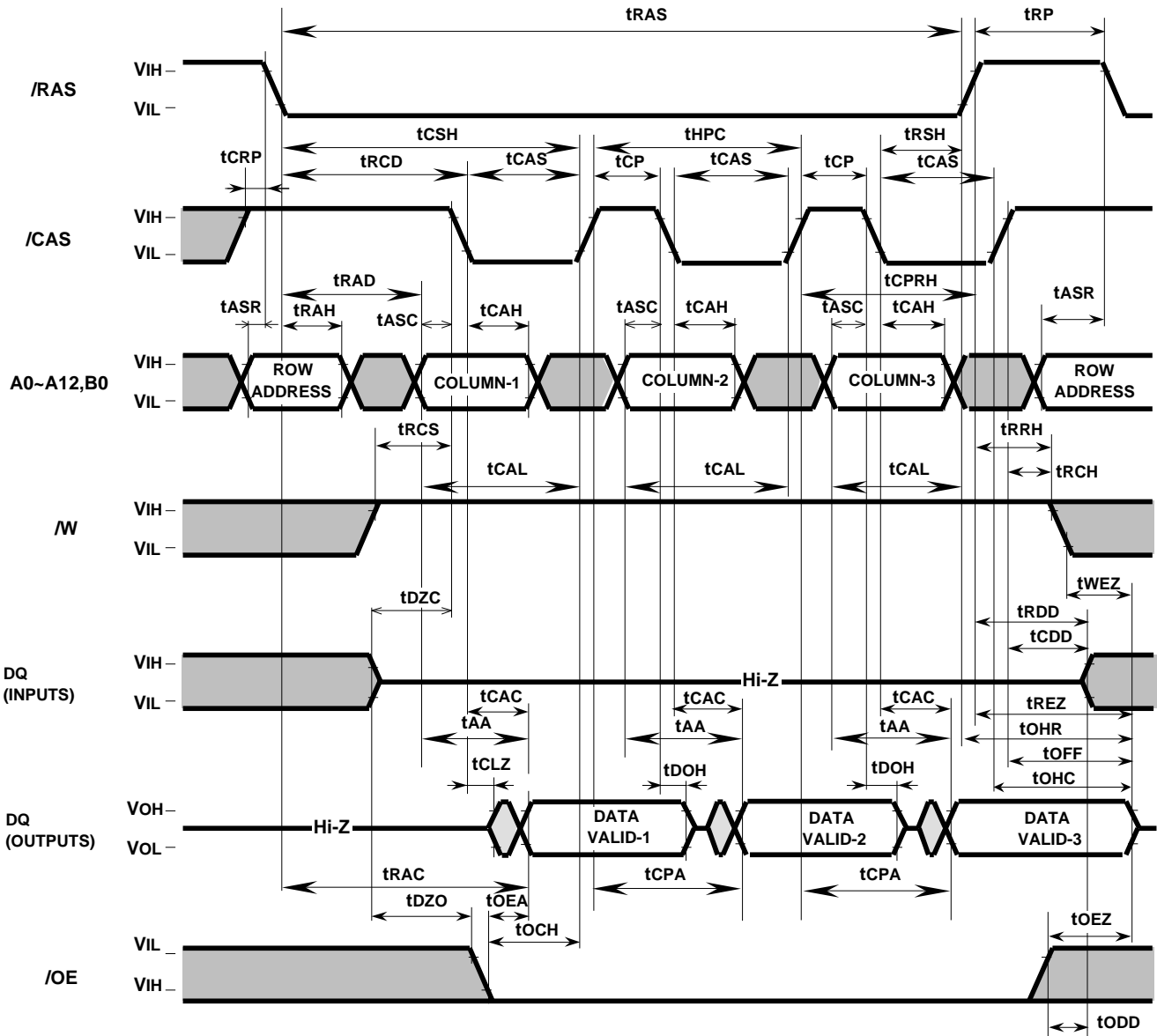

MH16V725BATJ -5, -6

HYPER PAGE MODE 1207959552 - BIT (16777216 - WORD BY 72 - BIT) DYNAMIC RAM

Hyper Page Mode Early Write Cycle

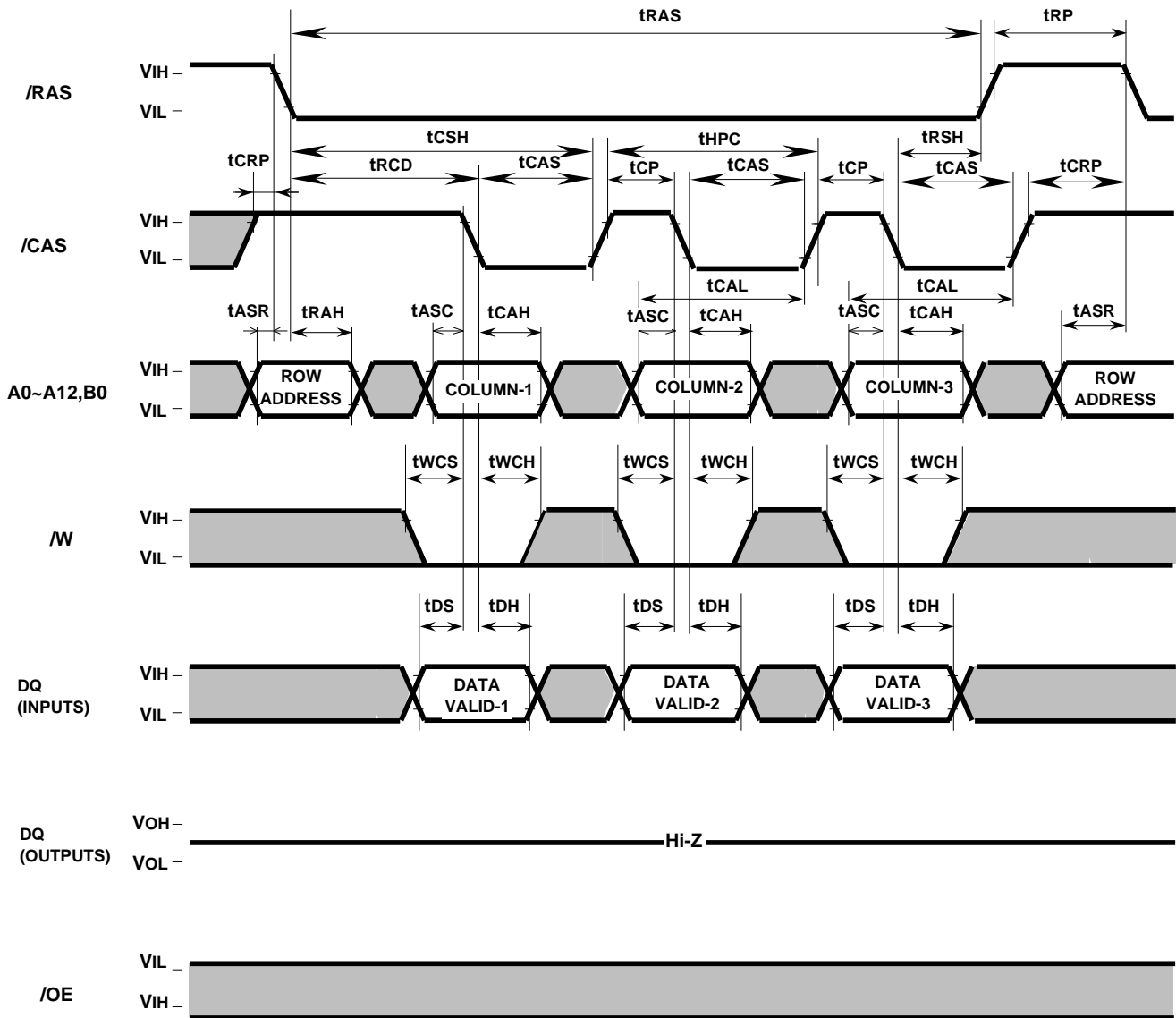

MH16V725BATJ -5, -6

HYPER PAGE MODE 1207959552 - BIT (16777216 - WORD BY 72 - BIT) DYNAMIC RAM

Hyper Page Mode Read-Write,Read-Modify-Write Cycle

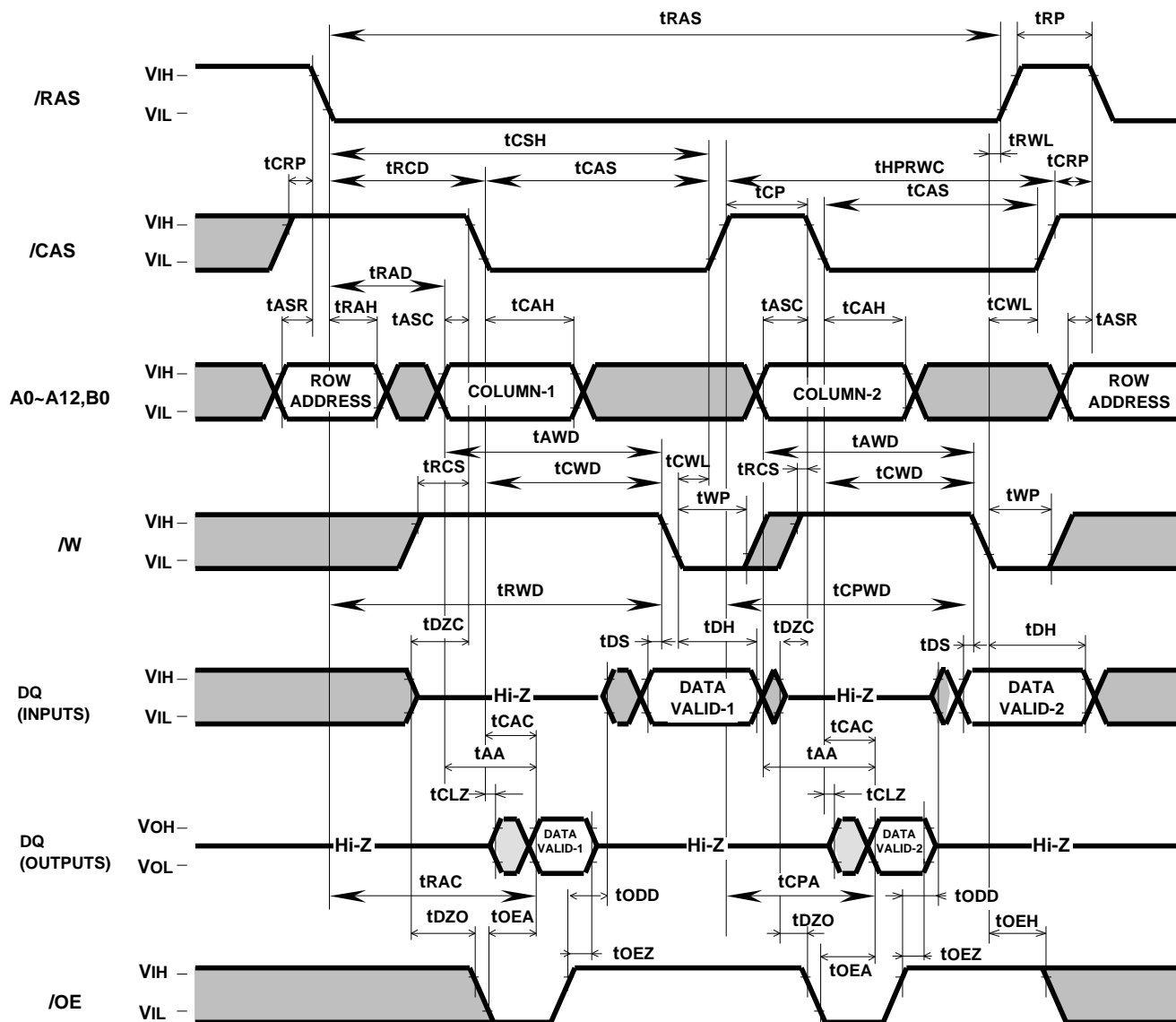

MH16V725BATJ -5, -6

HYPER PAGE MODE 1207959552 - BIT (16777216 - WORD BY 72 - BIT) DYNAMIC RAM

Hyper Page Mode Mix Cycle (1)

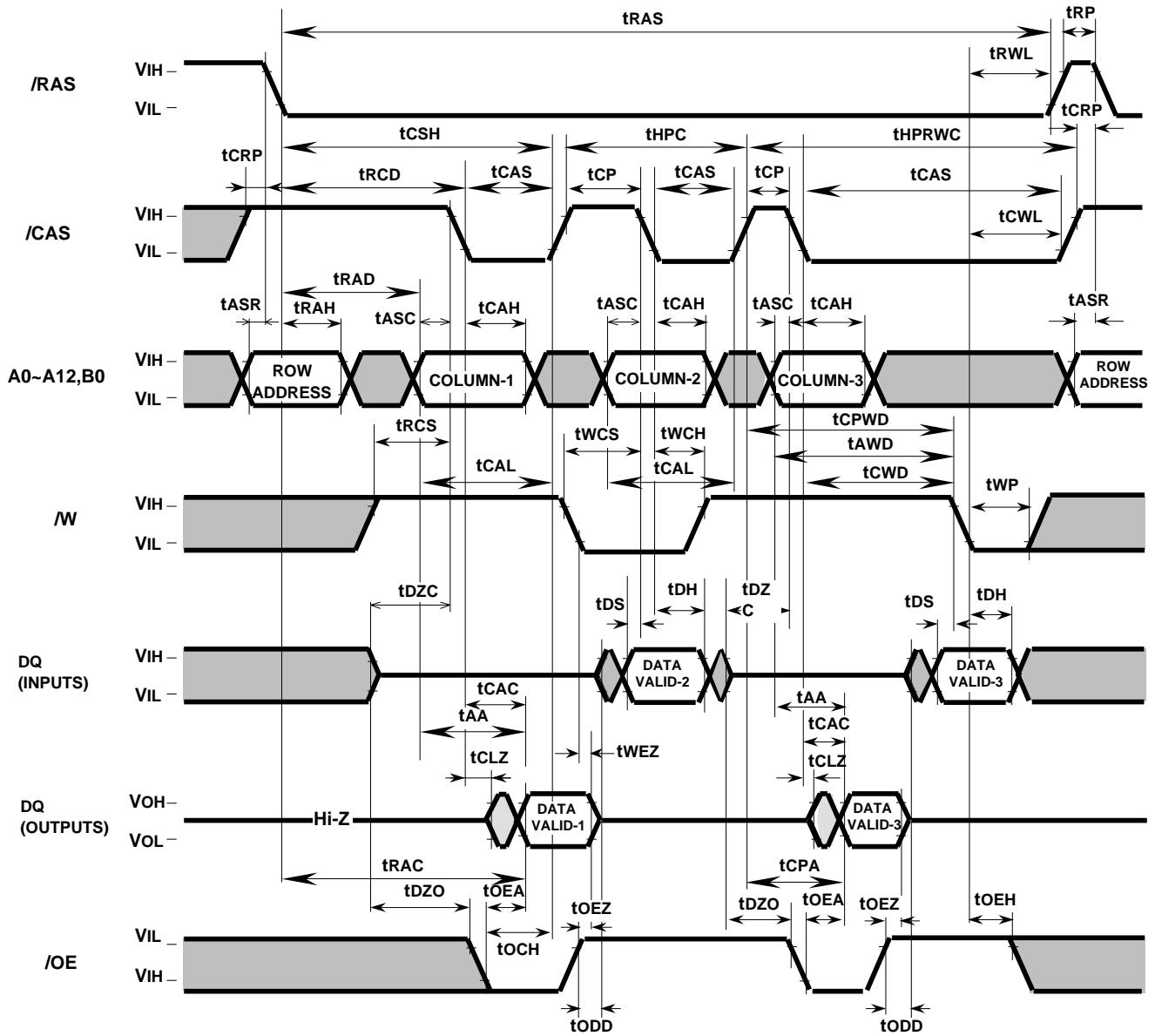

MH16V725BATJ -5, -6

HYPER PAGE MODE 1207959552 - BIT (16777216 - WORD BY 72 - BIT) DYNAMIC RAM

Hyper Page Mode Read Cycle (Hi-Z control by \overline{W})

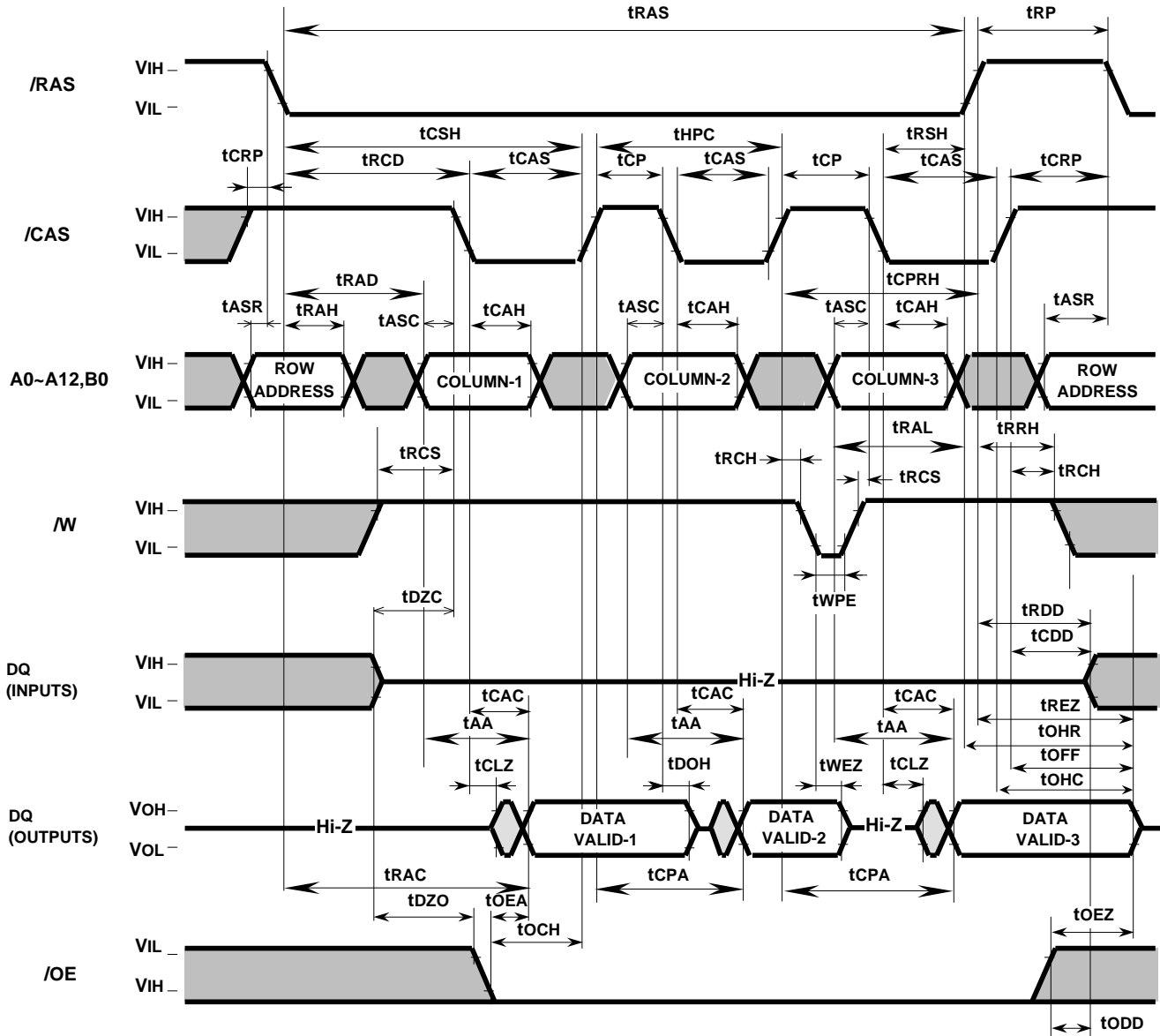

MH16V725BATJ -5, -6

HYPER PAGE MODE 1207959552 - BIT (16777216 - WORD BY 72 - BIT) DYNAMIC RAM

/CAS before /RAS Refresh Cycle

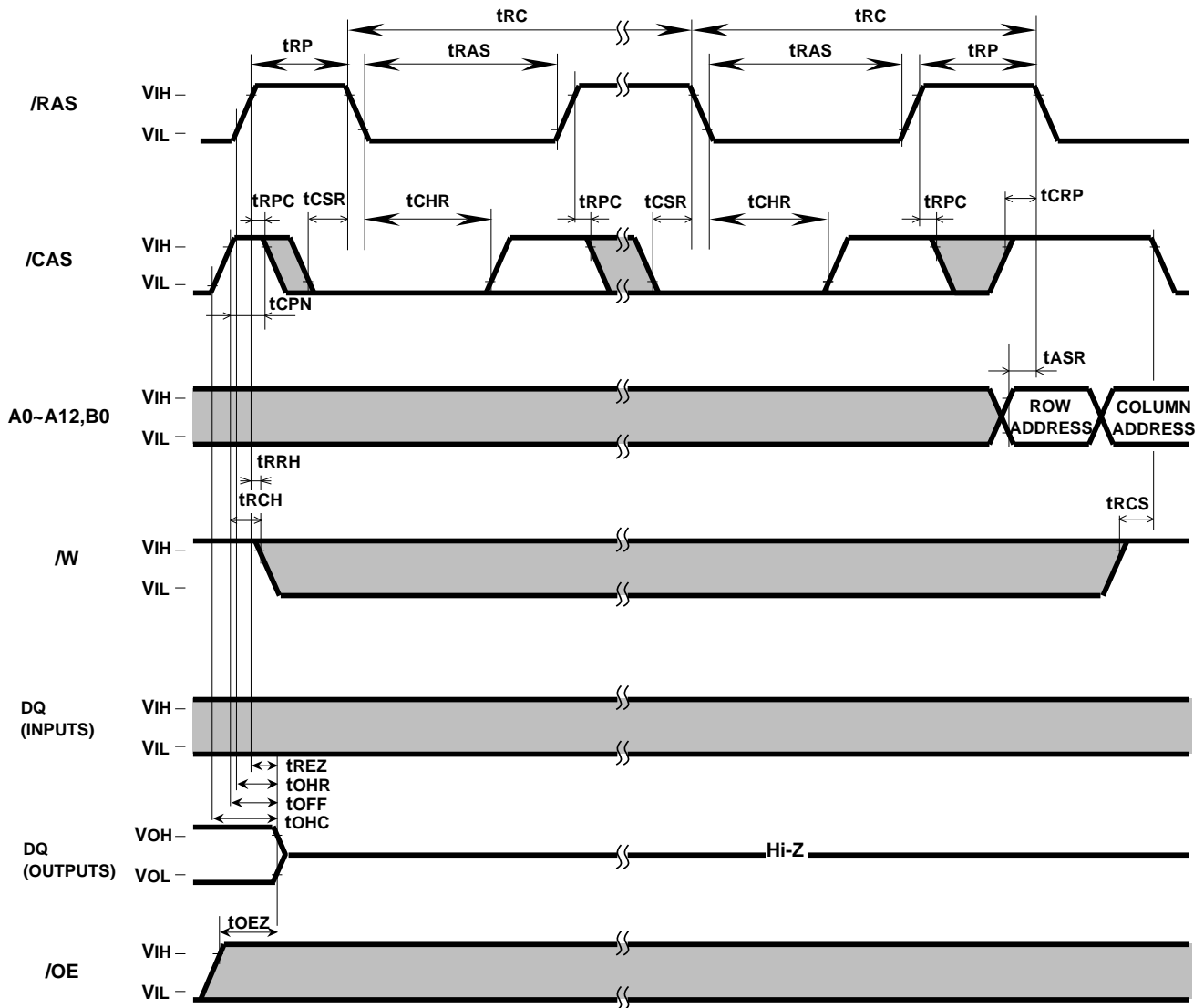

MH16V725BATJ -5, -6

HYPER PAGE MODE 1207959552 - BIT (16777216 - WORD BY 72 - BIT) DYNAMIC RAM

Hidden Refresh Cycle (Read) (Note 31)

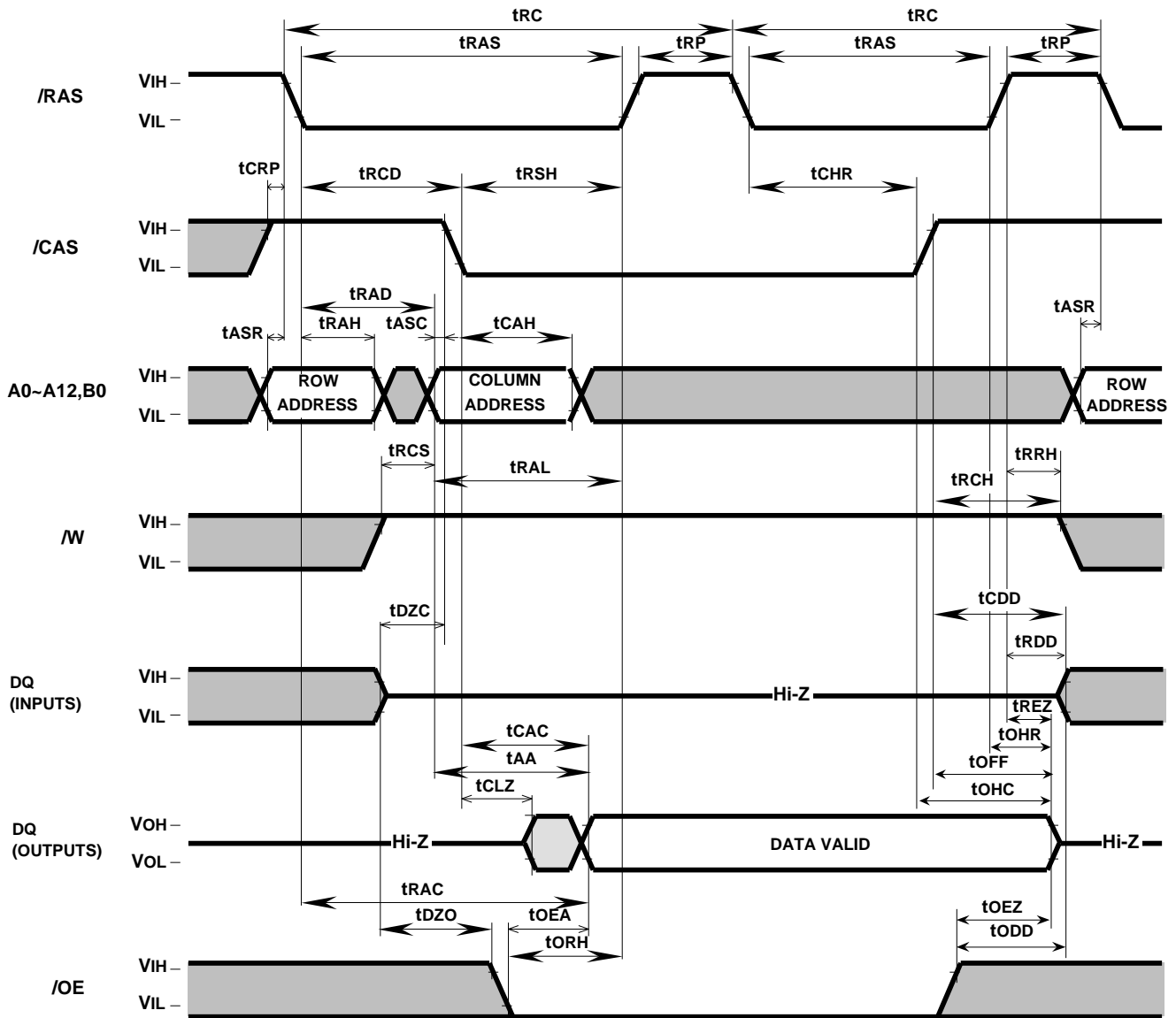

Note 31: Early write, delayed write, read write or read modify write cycle is applicable instead of read cycle. Timing requirements and output state are the same as that of each cycle shown above.

