

DESCRIPTION

2SC3001 is a silicon NPN epitaxial planar type transistor specifically designed for VHF power amplifier applications.

FEATURES

- High power gain: $G_{pe} \geq 13\text{dB}$.
@ $V_{CC} = 7.2\text{V}$, $f = 175\text{MHz}$, $P_{in} = 0.3\text{W}$.
- Emitter ballasted construction.
- High ruggedness: Ability to withstand more than 20:1 load VSWR when operated at $V_{CC} = 9\text{V}$, $f = 175\text{MHz}$, $P_O = 6.0\text{W}$.
- Flange type ceramic package.
- $Z_{in} = 1.5 - j1.3\Omega$, $Z_{out} = 5.0 - j1.2\Omega$
@ $V_{CC} = 7.2\text{V}$, $f = 175\text{MHz}$, $P_O = 6.0\text{W}$.

APPLICATION

For output stage of 5W power amplifiers in VHF band portable type radio sets.

OUTLINE DRAWING

Dimensions in mm

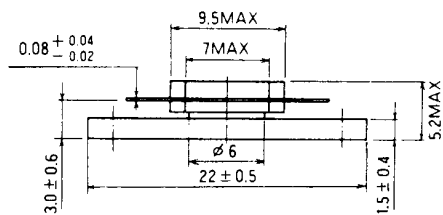
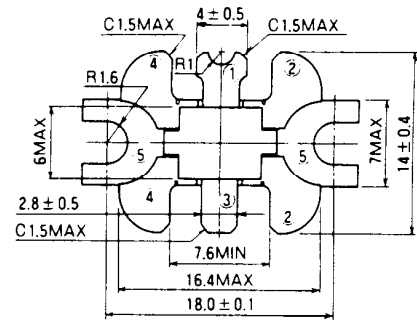

PIN :

- ① COLLECTOR
- ② EMITTER (FLANGE)
- ③ BASE
- ④ EMITTER (FLANGE)
- ⑤ FIN (EMITTER)

T-31E

ABSOLUTE MAXIMUM RATINGS ($T_C = 25^\circ\text{C}$)

Symbol	Parameter	Conditions	Ratings	Unit
V_{CBO}	Collector to base voltage		20	V
V_{EBO}	Emitter to base voltage		3.5	V
V_{CEO}	Collector to emitter voltage	$R_{BE} = \infty$	9	V
I_C	Collector current		3	A
P_C	Collector dissipation	$T_C = 25^\circ\text{C}$	20	W
T_J	Junction temperature		175	$^\circ\text{C}$
T_{stg}	Storage temperature		-55 to 175	$^\circ\text{C}$

Note. Above parameters are guaranteed independently.

ELECTRICAL CHARACTERISTICS ($T_C = 25^\circ\text{C}$)

Symbol	Parameter	Test conditions	Limits			Unit
			Min	Typ	Max	
$V_{(BR)EBO}$	Emitter to base breakdown voltage	$I_E = 5\text{mA}$, $I_C = 0$	3.5			V
$V_{(BR)CBO}$	Collector to base breakdown voltage	$I_C = 10\text{mA}$, $I_E = 0$	20			V
$V_{(BR)CEO}$	Collector to emitter breakdown voltage	$I_C = 50\text{mA}$, $R_{BE} = \infty$	9			V
I_{CBO}	Collector cut-off current	$V_{CB} = 10\text{V}$, $I_E = 0$			500	μA
I_{EBO}	Emitter cut-off current	$V_{EB} = 2\text{V}$, $I_C = 0$			500	μA
h_{FE}	DC forward current gain *	$V_{CE} = 5\text{V}$, $I_C = 0.1\text{A}$	20	50	180	--
P_O	Power Output	$V_{CC} = 7.2\text{V}$, $P_{in} = 0.3\text{W}$, $f = 175\text{MHz}$	6	7		W
η_C	Collector efficiency		60	65		%

Note. * Pulse test, $P_w = 150\mu\text{s}$, duty=5%.

Above parameters, ratings, limits and conditions are subject to change.

MITSUBISHI RF POWER TRANSISTOR
2SC3001

NPN EPITAXIAL PLANAR TYPE

TEST CIRCUIT (f = 175MHz)

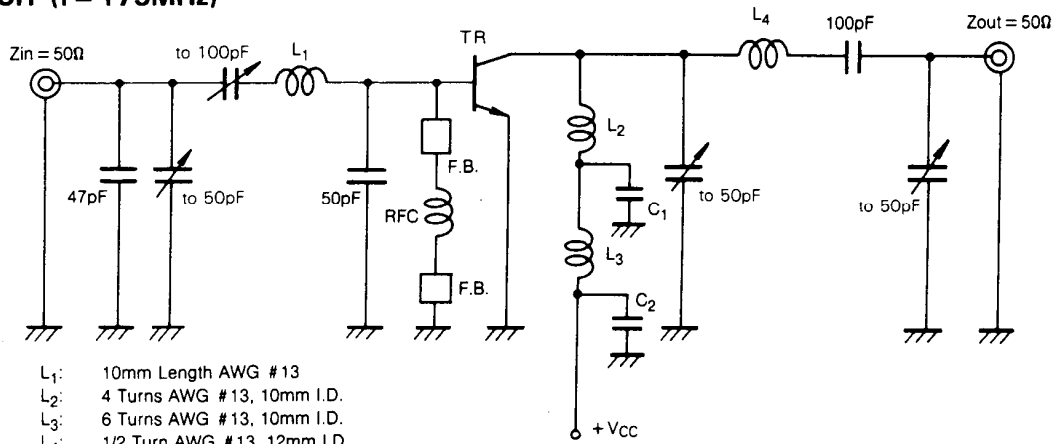

- L₁: 10mm Length AWG #13
- L₂: 4 Turns AWG #13, 10mm I.D.
- L₃: 6 Turns AWG #13, 10mm I.D.
- L₄: 1/2 Turn AWG #13, 12mm I.D.
- RFC: 40 Turns AWG #32 Enameled wire Close Wound on 4mm O.D.
14mm Length Bakelite.
- C₁: 220pF, 1000pF, 4700pF, 10μF in parallel.
- C₂: 220pF, 1000pF, 4700pF, 10μF in parallel.

TYPICAL PERFORMANCE DATA

COLLECTOR DISSIPATION VS. CASE TEMPERATURE CHARACTERISTICS

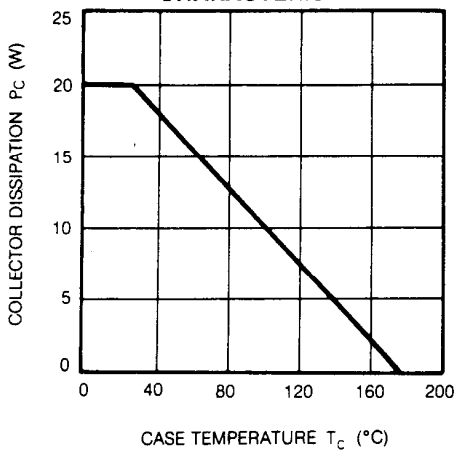

OUTPUT POWER, COLLECTOR EFFICIENCY VS. INPUT POWER CHARACTERISTICS.

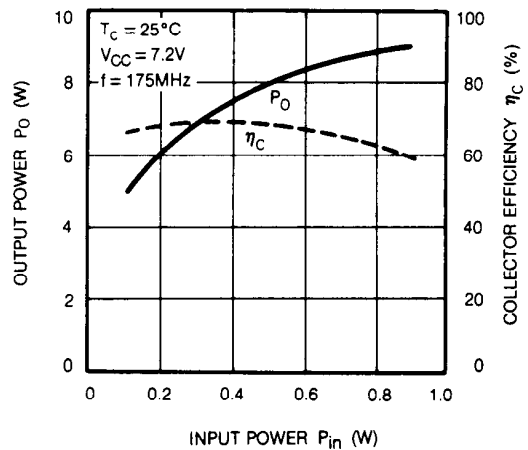

OUTPUT POWER VS. COLLECTOR SUPPLY VOLTAGE CHARACTERISTICS

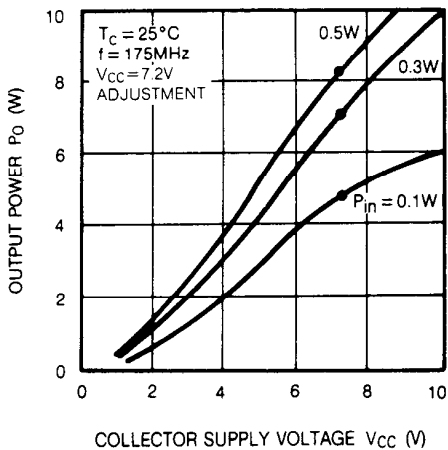

COLLECTOR OUTPUT CAPACITANCE VS. COLLECTOR TO BASE VOLTAGE CHARACTERISTICS

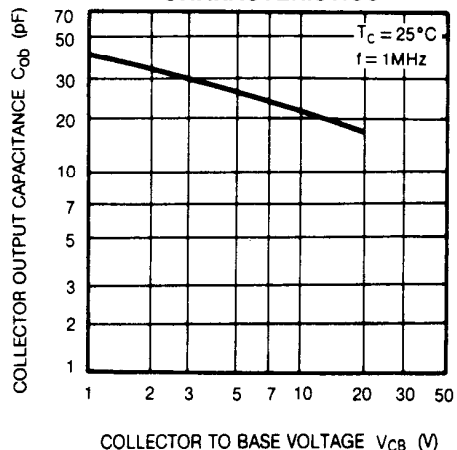

MITSUBISHI RF POWER TRANSISTOR
2SC3001

NPN EPITAXIAL PLANAR TYPE

**INPUT/OUTPUT IMPEDANCE VS.
 FREQUENCY CHARACTERISTICS**

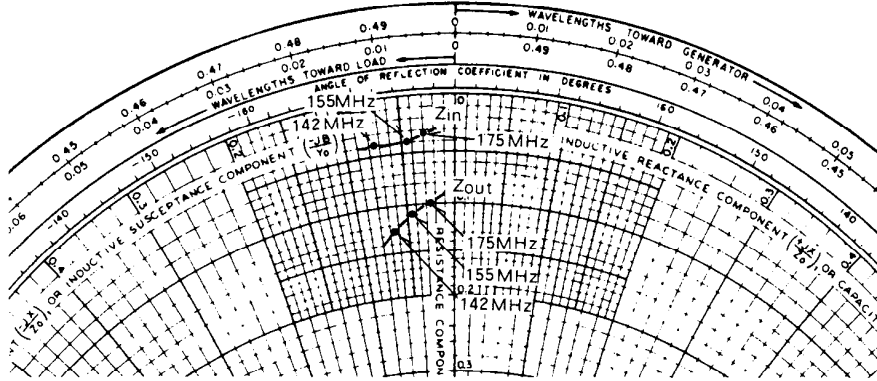

f (MHz)	Z _{in} (Ω)	Z _{out} (Ω)
142	2.0 - j3.6	6.0 - j3.2
155	1.8 - j2.0	5.4 - j2.3
175	1.5 - j1.3	5.0 - j1.2
V _{CC} = 7.2V, P _o = 6W		