

MITSUBISHI RF POWER TRANSISTOR 2SC3103

NPN EPITAXIAL PLANAR TYPE

DESCRIPTION

2SC3103 is a silicon NPN epitaxial planar type transistor specifically designed for UHF power amplifier applications.

FEATURES

- High power gain: $G_{pe} \geq 6.7\text{dB}$
@ $V_{CC} = 7.2\text{V}$, $f = 520\text{MHz}$, $P_{in} = 0.6\text{W}$.
- Emitter ballasted construction.
- High ruggedness: Ability to withstand more than 20:1 load VSWR when operated at $V_{CC} = 9\text{V}$, $f = 520\text{MHz}$, $P_o = 2.8\text{W}$
- Flange type ceramic package
- $Z_{in} = 1.8 - j1.9 \Omega$, $Z_{out} = 6.0 - j3.0 \Omega$ @ $V_{CC} = 7.2\text{V}$, $f = 520\text{MHz}$, $P_o = 2.8\text{W}$.

APPLICATION

For drive stage of 5W power amplifiers and output stage of up to 2W power amplifiers in UHF band portable type radio sets.

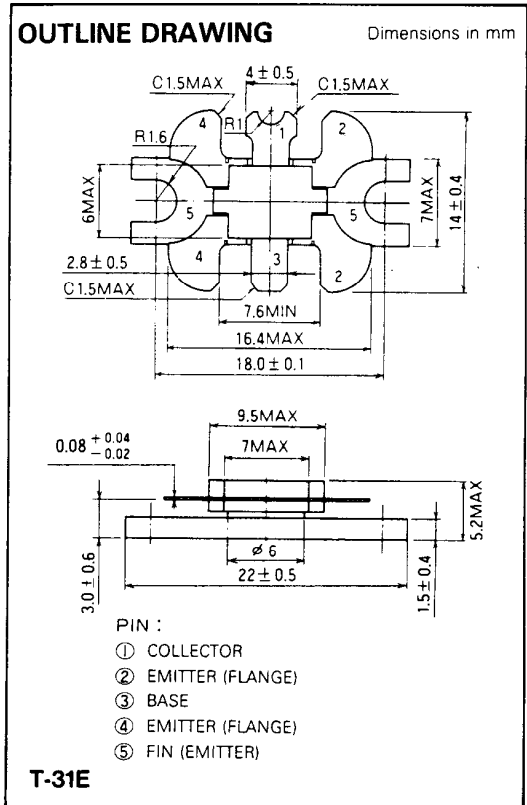

ABSOLUTE MAXIMUM RATINGS ($T_C = 25^\circ\text{C}$)

Symbol	Parameter	Conditions	Ratings	Unit
V_{CBO}	Collector to base voltage		20	V
V_{EBO}	Emitter to base voltage		3.5	V
V_{CEO}	Collector to emitter voltage	$R_{BE} = \infty$	9	V
I_C	Collector current		1.5	A
P_C	Collector dissipation	$T_C = 25^\circ\text{C}$	10	W
T_J	Junction temperature		175	$^\circ\text{C}$
T_{stg}	Storage temperature		-55 to 175	$^\circ\text{C}$
R_{th-c}	Thermal resistance	Junction to case	15	$^\circ\text{C}/\text{W}$

Note. Above parameters are guaranteed independently.

ELECTRICAL CHARACTERISTICS ($T_C = 25^\circ\text{C}$)

Symbol	Parameter	Test conditions	Limits			Unit
			Min	Typ	Max	
$V_{(BR)EBO}$	Emitter to base breakdown voltage	$I_E = 1\text{mA}$, $I_C = 0$	3.5			V
$V_{(BR)CBO}$	Collector to base breakdown voltage	$I_C = 10\text{mA}$, $I_E = 0$	20			V
$V_{(BR)CEO}$	Collector to emitter breakdown voltage	$I_C = 10\text{mA}$, $R_{BE} = \infty$	9			V
I_{CBO}	Collector cut-off current	$V_{CB} = 10\text{V}$, $I_E = 0$			300	μA
I_{EBO}	Emitter cut-off current	$V_{EB} = 2\text{V}$, $I_C = 0$			300	μA
h_{FE}	DC forward current gain *	$V_{CE} = 5\text{V}$, $I_C = 0.1\text{A}$	10	50	180	—
P_o	Power Output	$V_{CC} = 7.2\text{V}$, $P_{in} = 0.6\text{W}$, $f = 520\text{MHz}$	2.8	3.2		W
η_C	Collector efficiency		55	60		%

Note. * Pulse test, $P_W = 150\mu\text{s}$, duty = 5%.

Above parameters, ratings, limits and conditions are subject to change.

TEST CIRCUIT (f = 520MHz)

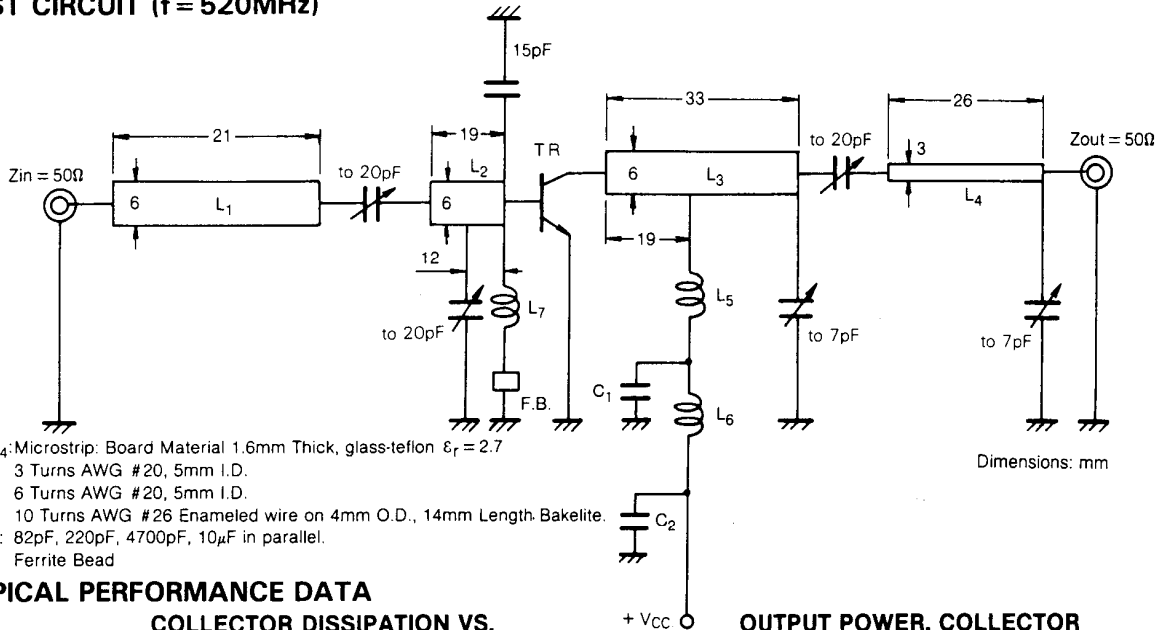

L₁ to L₄: Microstrip: Board Material 1.6mm Thick, glass-teflon $\epsilon_r = 2.7$
 L₅: 3 Turns AWG #20, 5mm I.D.
 L₆: 6 Turns AWG #20, 5mm I.D.
 L₇: 10 Turns AWG #26 Enameled wire on 4mm O.D., 14mm Length. Bakelite.
 C₁, C₂: 82pF, 220pF, 4700pF, 10 μ F in parallel.
 F.B.: Ferrite Bead

TYPICAL PERFORMANCE DATA

COLLECTOR DISSIPATION VS. CASE TEMPERATURE CHARACTERISTICS

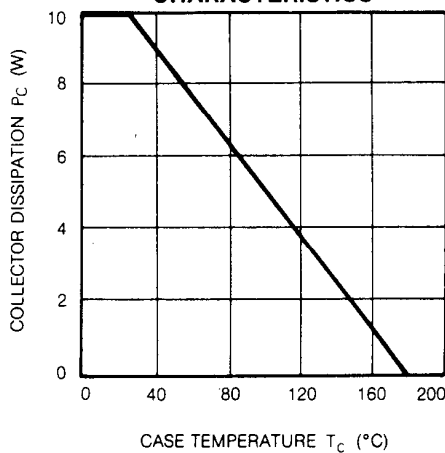

OUTPUT POWER, COLLECTOR EFFICIENCY VS. INPUT POWER CHARACTERISTICS

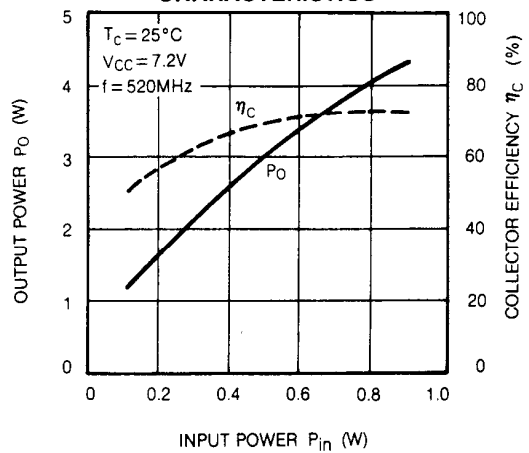

OUTPUT POWER VS. COLLECTOR SUPPLY VOLTAGE CHARACTERISTICS

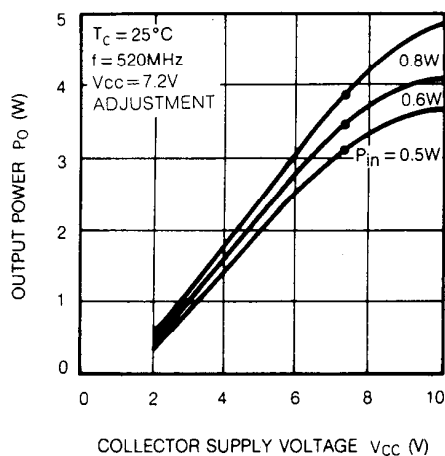

COLLECTOR OUTPUT CAPACITANCE VS. COLLECTOR TO BASE VOLTAGE CHARACTERISTICS

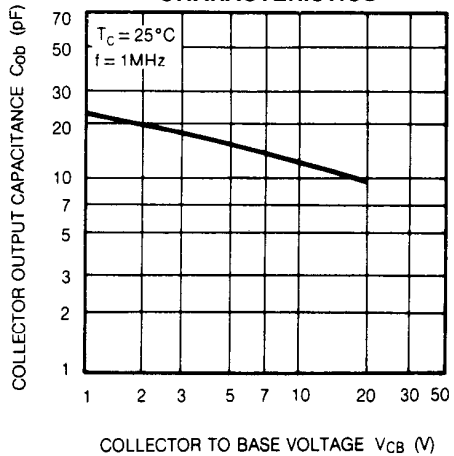

OUTPUT POWER VS. FREQUENCY

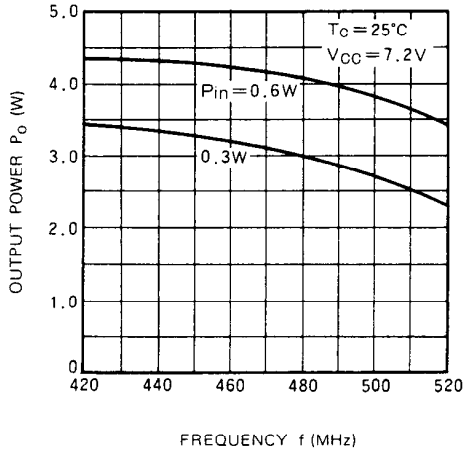

DC CURRENT GAIN VS. COLLECTOR CURRENT

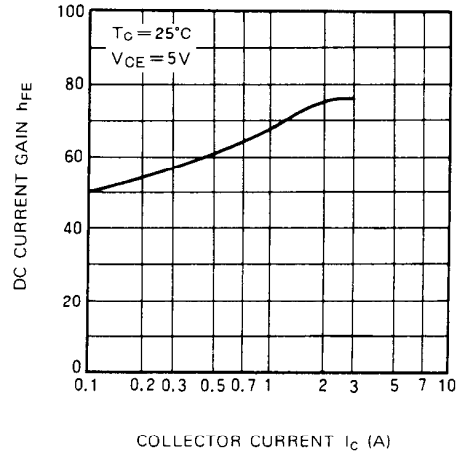

INPUT/OUTPUT IMPEDANCE VS. FREQUENCY

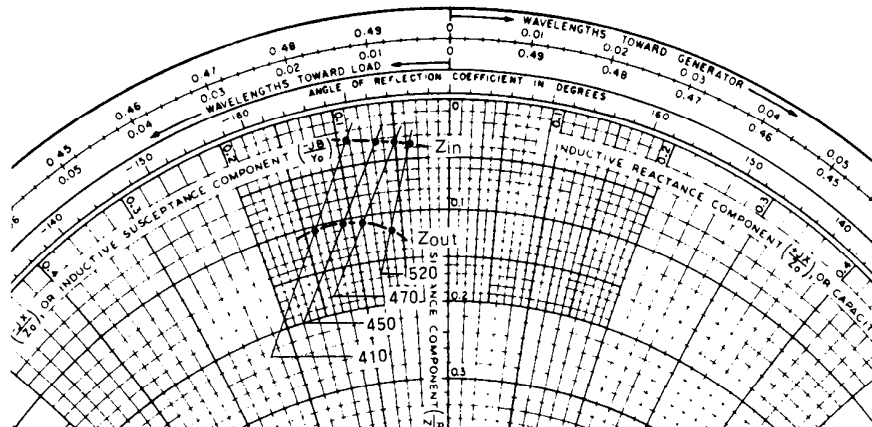

f (MHz)	$Z_{in} (\Omega)$	$Z_{out} (\Omega)$
410	$1.5 - j4.5$	$5.5 - j7.0$
450	$1.5 - j3.5$	$5.3 - j5.5$
470	$1.6 - j2.5$	$5.4 - j4.5$
520	$1.8 - j1.9$	$6.0 - j3.0$

$V_{CC} = 7.2\text{V}$, $P_o = 2.8\text{W}$