

DESCRIPTION

2SC4989 is a silicon NPN epitaxial planar type transistor specifically designed for high power amplifiers in UHF band.

FEATURES

- High power output and high gain : $P_o \geq 65W$, $G_{pe} \geq 5.1dB$,
@ $V_{cc} = 12.5V$, $f = 520MHz$, $P_{in} = 20W$
- Emitter ballasted construction.
- Load mismatch : Ability to withstand more than 8 : 1 load VSWR when operated at $V_{cc} = 15.2V$, $P_o = 65W$,
 $f = 520MHz$,
- High reliability due to gold metalization die.
- Flange type ceramic package.

APPLICATIONS

For output stage of 50W power amplifiers in UHF band.

OUTLINE DRAWING

Dimension in mm

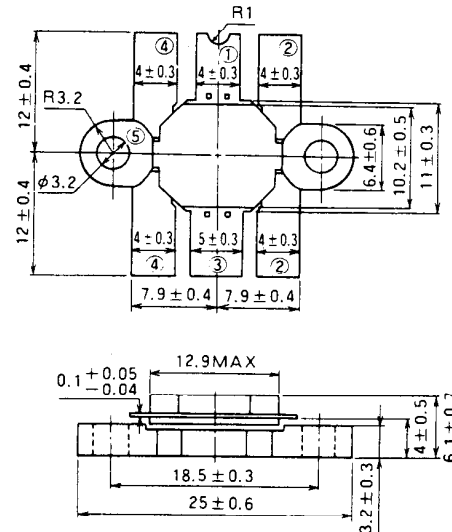

- PIN :
- ① COLLECTOR
 - ② EMITTER (FLANGE)
 - ③ BASE
 - ④ EMITTER (FLANGE)
 - ⑤ FIN (EMITTER)

T-40E

ABSOLUTE MAXIMUM RATINGS ($T_c = 25^\circ C$ unless otherwise noted)

Symbol	Parameter	Conditions	Ratings	Unit
V_{cbo}	Collector-base voltage		35	V
V_{ebo}	Emitter-base voltage		4	V
V_{ceo}	Collector-emitter voltage	$R_{BE} = \infty$	17	V
I_c	Collector current		20	A
P_c	Collector dissipation		150	W
T_j	Junction temperature		175	$^\circ C$
T_{stg}	Storage temperature		- 55 to 175	$^\circ C$

Note. Above parameters are guaranteed independently.

ELECTRICAL CHARACTERISTICS ($T_c = 25^\circ C$ unless otherwise noted)

Symbol	Parameter	Test conditions	Limits		Unit
			Min	Max	
$V_{(BR)CBO}$	Collector-base breakdown voltage	$I_c = 20mA$, $I_E = 0$	35		V
$V_{(BR)EBO}$	Emitter-base breakdown voltage	$I_E = 20mA$, $I_c = 0$	4		V
$V_{(BR)CEO}$	Collector-emitter breakdown voltage	$I_c = 100mA$, $R_{BE} = \infty$	17		V
I_{cbo}	Collector cutoff current	$V_{CB} = 15V$, $I_E = 0$		5	mA
I_{ebo}	Emitter cutoff current	$V_{EB} = 3V$, $I_c = 0$		5	mA
h_{FE}	DC forward current gain	$V_{CE} = 5V$, $I_c = 5A$	10	180	-
P_o	Output power	$V_{cc} = 12.5V$, $f = 520MHz$, $P_{in} = 20W$	65		W
η_c	Collector efficiency		55		%

Note. Above parameters, ratings, limits and conditions are subject to change.

TEST CIRCUIT
(f = 520MHz)

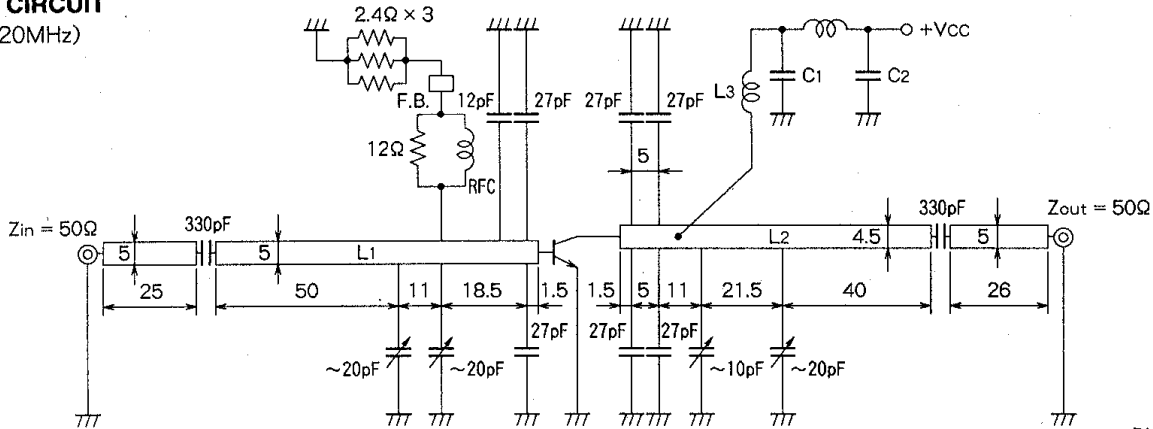

Dimensions in mm

L1, L2: Microstrip: Board material 1.6mm thick, glass-teflon $\epsilon_r = 2.6$
 L3: 5D, 2Turn, 1P, $\phi 1.6$ mm silver plated copper wire
 L4: 5D, 5Turn, 1P, $\phi 1.6$ mm silver plated copper wire
 RFC: 5D, 8Turn, 1P, $\phi 0.7$ mm enameled wire

F.B: Ferrite Bead
 C1: 47pF, 2200pF, 22000pF, 2200 μ F in Paralleled
 C2: 47pF, 2200pF, 22000pF, 2200 μ F, 100 μ F

TYPICAL PERFORMANCE DATA

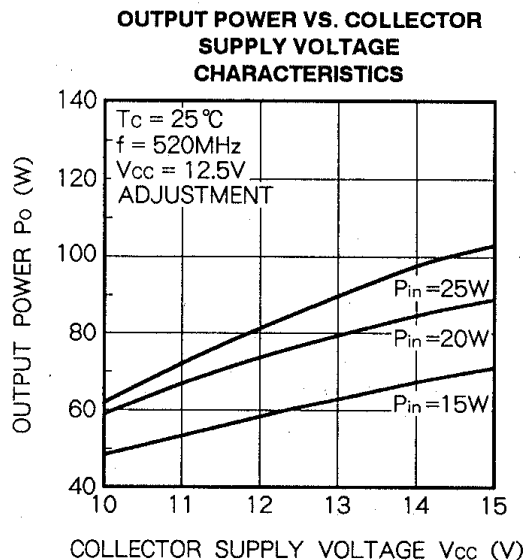
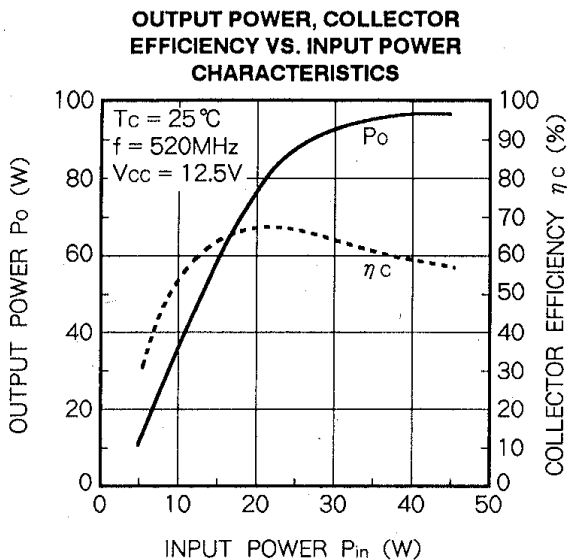
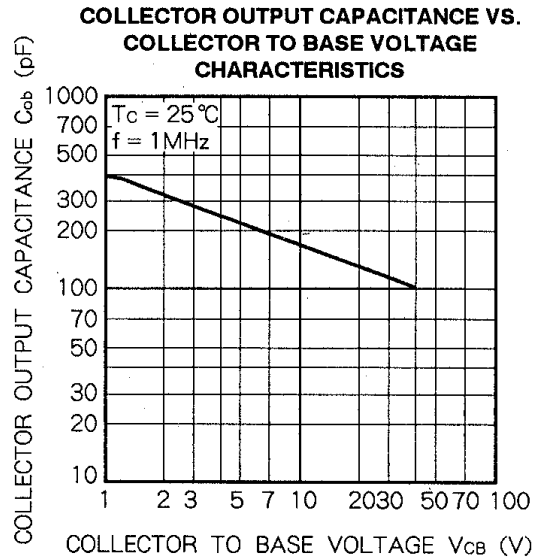
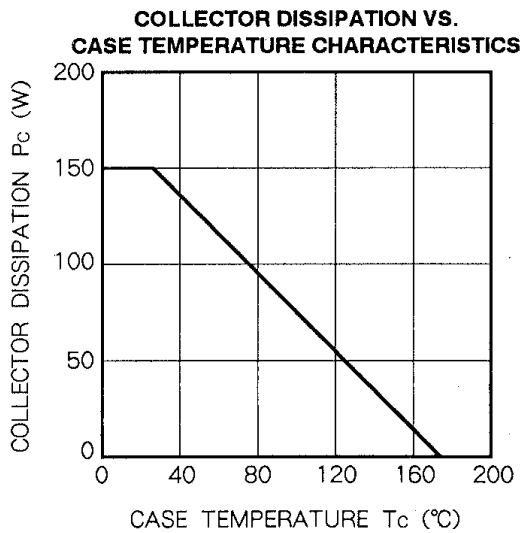

TEST CIRCUIT
(f = 520MHz)

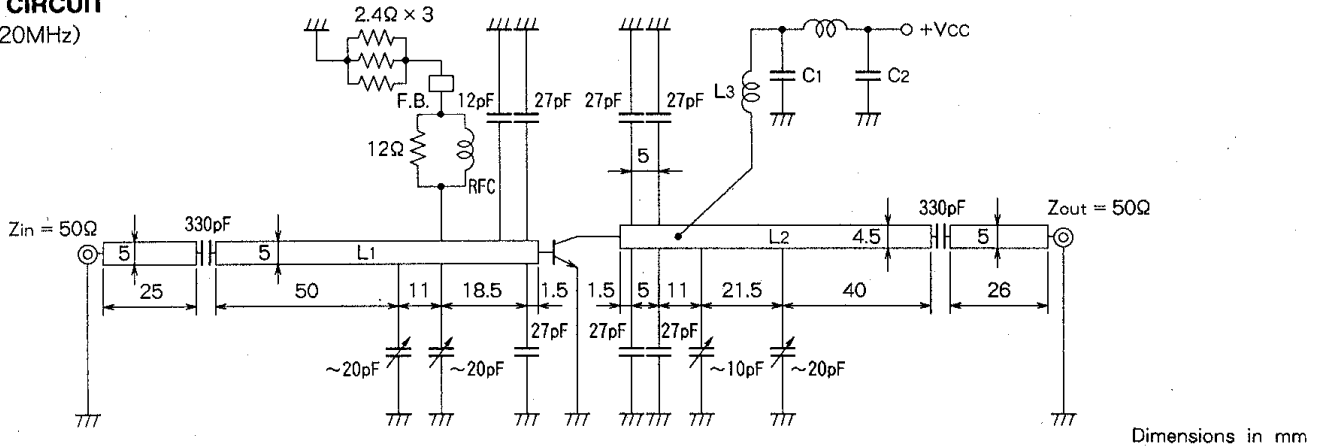

L1, L2: Microstrip: Board material 1.6mm thick, glass-teflon $\epsilon_r = 2.6$
 L3: 5D, 2Turn, 1P, $\phi 1.6$ mm silver plated copper wire
 L4: 5D, 5Turn, 1P, $\phi 1.6$ mm silver plated copper wire
 RFC: 5D, 8Turn, 1P, $\phi 0.7$ mm enameled wire

F.B: Ferrite Bead
 C1: 47pF, 2200pF, 22000pF, 2200 μ F in Paralleled
 C2: 47pF, 2200pF, 22000pF, 2200 μ F, 100 μ F

TYPICAL PERFORMANCE DATA

