

DESCRIPTION

2SC3908 is a silicon NPN epitaxial planar type transistor designed for HF power amplifiers applications.

FEATURES

- High power gain: $G_{pe} \geq 11.5\text{dB}$
@ $P_O = 100\text{W}$, $f = 30\text{MHz}$, $V_{CC} = 12.5\text{V}$
- The ability withstand infinite VSWR when operated at $f = 30\text{MHz}$, $V_{CC} = 12.5\text{V}$, $P_O = 100\text{W}$.
- Flange type ceramic package.

APPLICATION

For output stage of 100 – 150W power amplifiers in HF band SSB mobile radio sets. (Push-pull operation)

OUTLINE DRAWING

Dimensions in mm

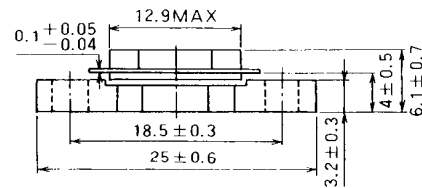
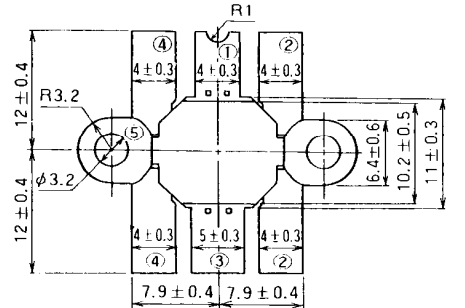

PIN :

- (1) COLLECTOR
- (2) EMITTER (FLANGE)
- (3) BASE
- (4) EMITTER (FLANGE)
- (5) FIN (EMITTER)

T-40E

ABSOLUTE MAXIMUM RATINGS ($T_C = 25^\circ\text{C}$ unless otherwise specified)

Symbol	Parameter	Conditions	Rating	Unit
V_{CBO}	Collector to base voltage		50	V
V_{EBO}	Emitter to base voltage		5	V
V_{CEO}	Collector to emitter voltage	$R_{BE} = \infty$	20	V
I_C	Collector current		22	A
P_C	Collector dissipation	$T_a = 25^\circ\text{C}$	7.8	W
		$T_C = 25^\circ\text{C}$	200	W
T_j	Junction temperature		175	$^\circ\text{C}$
T_{stg}	Storage temperature		-55 to 175	$^\circ\text{C}$
R_{th-a}	Thermal resistance		19.2	$^\circ\text{C}/\text{W}$
R_{th-c}			0.75	$^\circ\text{C}/\text{W}$

Note. Above parameters are guaranteed independently.

ELECTRICAL CHARACTERISTICS ($T_C = 25^\circ\text{C}$ unless otherwise specified)

Symbol	Parameter	Test conditions	Limits			Unit
			Min	Typ	Max	
$V_{(BR)EBO}$	Emitter to base breakdown voltage	$I_C = 20\text{mA}$, $I_E = 0$	50			V
$V_{(BR)CBO}$	Collector to base breakdown voltage	$I_E = 20\text{mA}$, $I_C = 0$	5			V
$V_{(BR)CEO}$	Collector to emitter breakdown voltage	$I_C = 0.1\text{A}$, $R_{BE} = \infty$	20			V
I_{CBO}	Collector cutoff current	$V_{CB} = 15\text{V}$, $I_E = 0$			5	mA
I_{EBO}	Emitter cutoff current	$V_{EB} = 3\text{V}$, $I_C = 0$			5	mA
h_{FE}	DC forward current gain	$V_{CE} = 10\text{V}$, $I_C = 1\text{A}$	10	50	180	—
P_O	Output power	$f = 30\text{MHz}$, $V_{CC} = 12.5\text{V}$, $P_{in} = 7\text{W}$	100	110		W
η_C	Collector efficiency		55	60		%

Note. * Pulse test, $P_W = 150\mu\text{s}$, duty = 5%.

Above parameters, ratings, limits and conditions are subject to change.

NPN EPITAXIAL PLANAR TYPE

TEST CIRCUIT

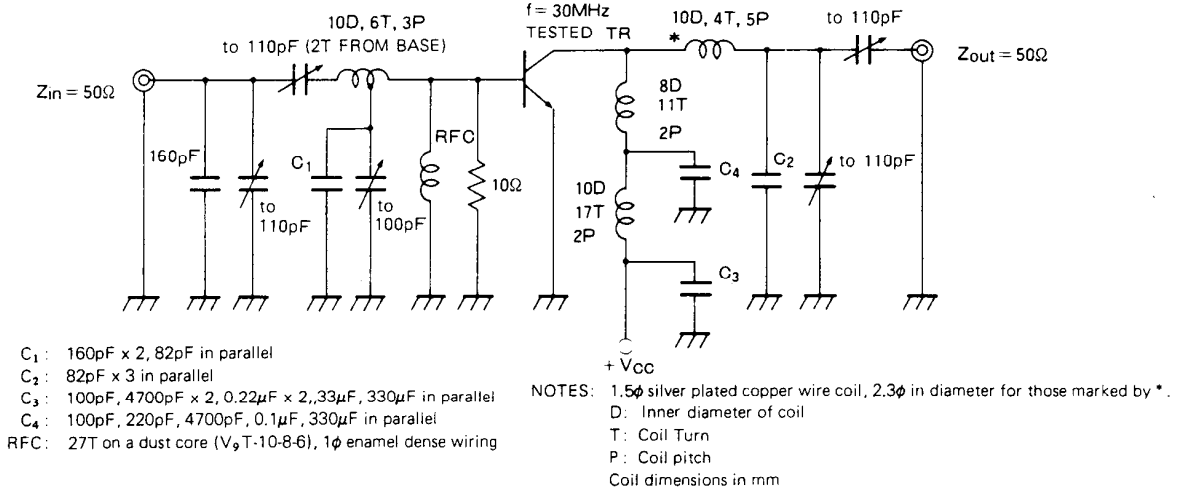

TYPICAL PERFORMANCE DATA

COLLECTOR DISSIPATION VS. AMBIENT TEMPERATURE

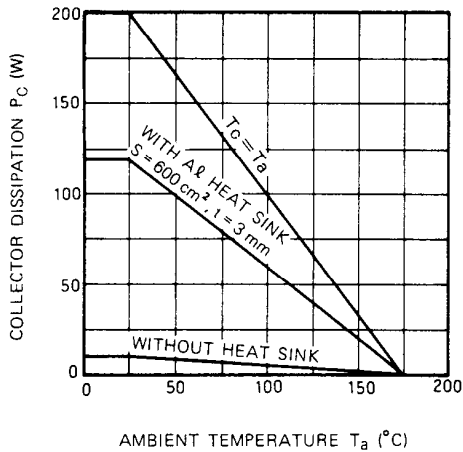

COLLECTOR CURRENT VS. COLLECTOR TO EMITTER VOLTAGE

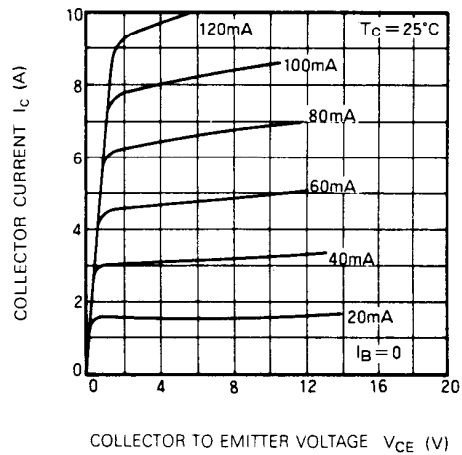

COLLECTOR TO EMITTER BREAKDOWN VOLTAGE VS. BASE TO EMITTER RESISTANCE

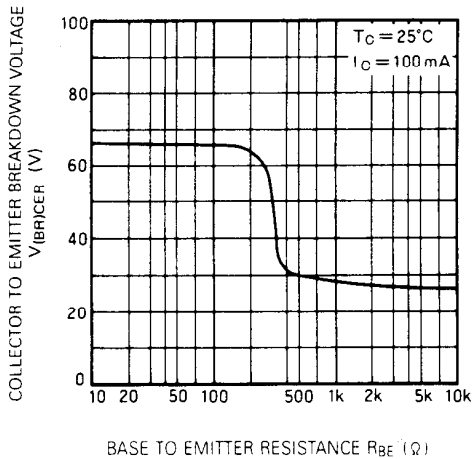

DC CURRENT GAIN VS. COLLECTOR CURRENT

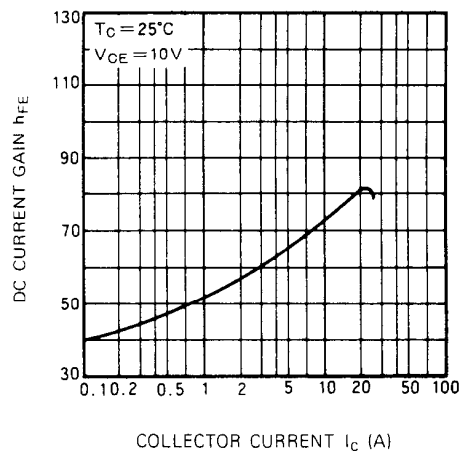

MITSUBISHI RF POWER TRANSISTOR
2SC3908

NPN EPITAXIAL PLANAR TYPE

COLLECTOR OUTPUT CAPACITANCE VS. COLLECTOR TO BASE VOLTAGE

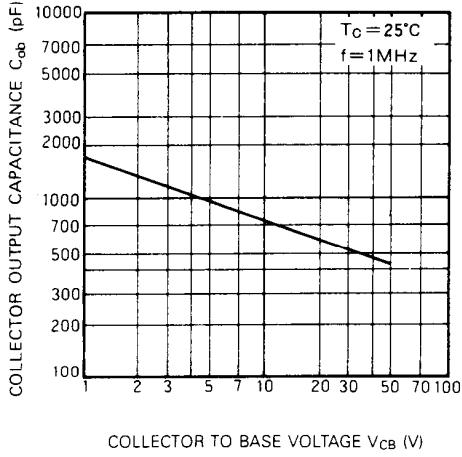

OUTPUT POWER, COLLECTOR EFFICIENCY VS. INPUT POWER

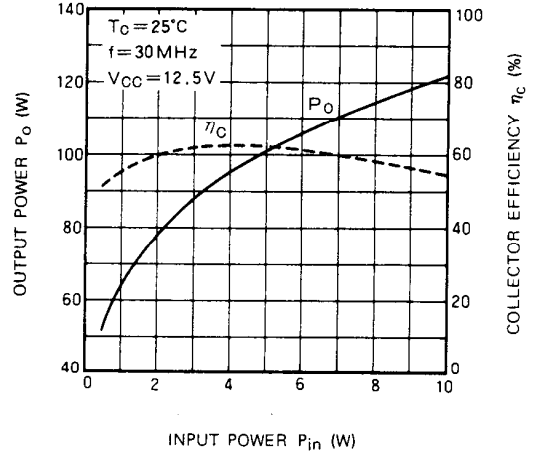

OUTPUT POWER, COLLECTOR SUPPLY VOLTAGE VARIATION

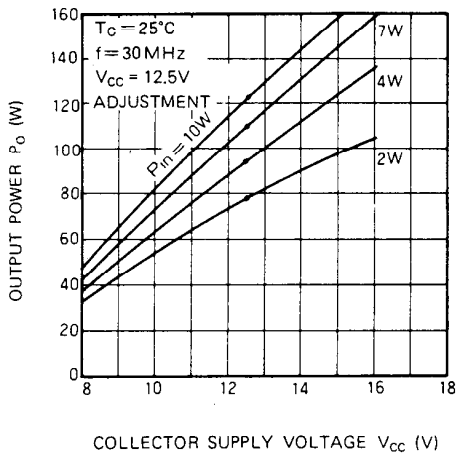

NPN EPITAXIAL PLANAR TYPE

PRECAUTIONS FOR USE

Mitsubishi transistors have high reliability and good performance, as they are designed and manufactured under strict quality control. However, the characteristics and reliability of semiconductor devices are greatly affected by usage conditions if inappropriate thermal, mechanical or electrical stresses are applied.

To keep high reliability and obtain good performance when using Mitsubishi transistors, the following important points should be noted before use:

1. OPERATING JUNCTION TEMPERATURE

T_j (OP)

When designing a heat sink, keep the operating junction temperature $T_{j(OP)}$ below 130°C at ambient temperature $T_a = 60^{\circ}\text{C}$.

2. BASE-EMITTER EXTERNALLY CONNECTED RESISTOR

If a base-emitter bias resistor is inserted for AB class or C class amplifiers, the resistance value should be minimized. (Normally less than 5Ω to 10Ω .) If this value is too large, exciting input is increased and reverse bias current is applied to base and emitter and the emitter-base junction breaks down because of this exciting input, thus reducing h_{FE} and output power.

3. MOUNTING METHOD

- (1) Use fastening screws of M3 x 0.5.
- (2) Fastening torque of screw is recommended as 5 to 6 kg-cm.
- (3) Application of compound: Thermal compound to get good heat sinking should be applied to the bottom of the flange, fastening screws, as well as inside flange holes and holes of module's fin.

- (4) The distance between the centers of screw holes of heat sink fins should be $18.3 \pm 0.2\text{mm}$ and the diameter of holes should be 3.5 mm.
- (5) When mounting the device to the substrate, do not apply upper tensile force to the leads.
- (6) The temperature of lead soldering should be less than 250°C and shorter than 8 seconds.

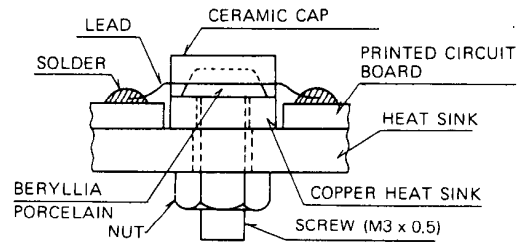

4. GUARANTEED CHARACTERISTICS

All the graphic characteristics illustrated in this catalog are typical examples. The characteristics of individual devices as specified in the tables of absolute maximum ratings and electrical characteristics are guaranteed under the specified conditions.

5. PROCESSING OF DEFECTIVE PRODUCT OR DISCARDED PRODUCT

Beryllia porcelain is used in the transistor package. Dust or vapor of beryllia porcelain is extremely harmful to you. Do not cut, crack, or carve the device or do not process the device at high temperature (more than 800°C) in humid atmosphere.