

Low-Ripple, Low-Saturation CMOS Regulators Monolithic IC MM309X, MM310X Series

Outline

This is a voltage regulator IC developed using the CMOS process.

Use of the CMOS process allows low current consumption, and it has superior ripple rejection ratio and transient response compared to conventional CMOS process regulator ICs, making it ideal for use in portable communications devices.

Ceramic capacitors can be used for the output capacitors.

Ideal for small, portable devices as SOT-25 and WLCSP are used for the package.

Features

1. Super low consumption current	45 μ A typ. (when not loaded, excluding the CE terminal current)
2. Super low consumption current (when off)	0.1 μ A typ.
3. High precision output voltage	\pm 2%
4. Output current	150mA
5. Input/output voltage difference	0.23V typ. (I _o =100mA, 3V output)
6. High ripple rejection ratio	80dB typ.
7. Built-in short-circuit restriction circuit	30mA typ.
8. Wide operating temperature range	-30~+85°C
9. Output voltage	1.8~5.0V (0.1V step)

Package

SOT-25, WLCSP-4 (MM309X),
WLCSP-5 (MM310X)

Applications

1. Constant voltage power supply for devices that use batteries
2. Constant voltage power supply for portable communications devices
3. Constant voltage power supply for household electronics products

Block Diagram

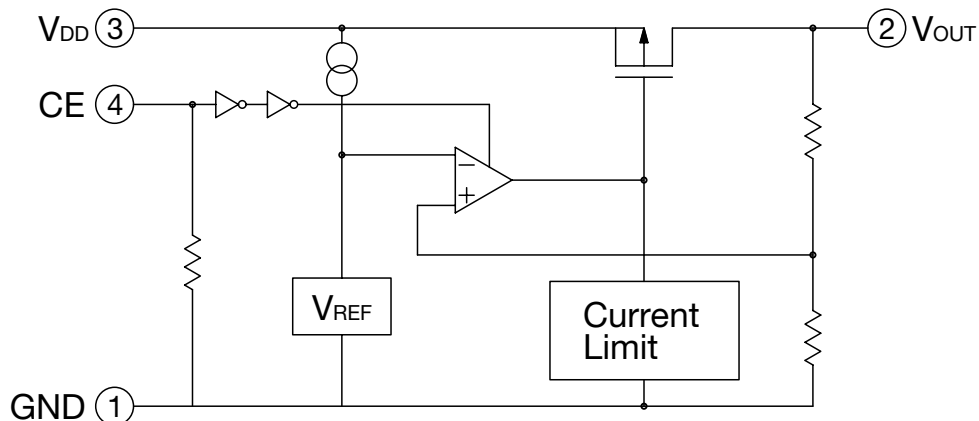

Pin Assignment

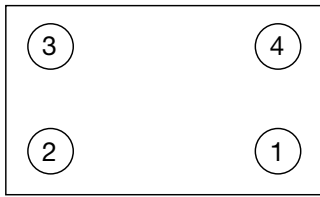

WLCSP-4
(BOTTOM VIEW)

1	GND
2	V _{OUT}
3	V _{DD}
4	CE

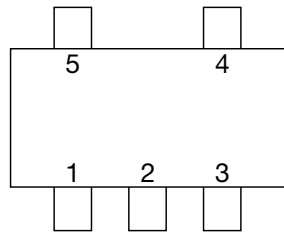

SOT-25A
(TOP VIEW)

1	V _{OUT}
2	GND
3	V _{DD}
4	CE
5	V _{DD}

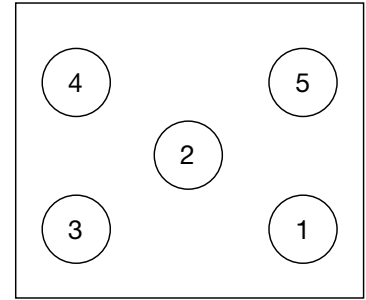

WLCSP-5
(BOTTOM VIEW)

1	CE
2	GND
3	V _{OUT}
4	V _{DD}
5	NC

Pin Description

■ WLCSP-4

Pin No.	Pin name	Functions						
1	GND	GND pin						
2	V _{OUT}	Regulator output pin						
3	V _{DD}	Voltage-supply pin						
4	CE	ON/OFF-Control pin						
		<table border="1"> <tr><td>CE</td><td>OUTPUT</td></tr> <tr><td>L</td><td>OFF</td></tr> <tr><td>H</td><td>ON</td></tr> </table>	CE	OUTPUT	L	OFF	H	ON
		CE	OUTPUT					
		L	OFF					
H	ON							
Connect CE pin with V _{DD} pin, when it is not used.								

■ SOT-25A

Pin No.	Pin name	Functions						
1	V _{OUT}	Regulator output pin						
2	GND	GND pin						
3,5	V _{DD}	Voltage-supply pin						
4	CE	ON/OFF-Control pin						
		<table border="1"> <tr><td>CE</td><td>OUTPUT</td></tr> <tr><td>L</td><td>OFF</td></tr> <tr><td>H</td><td>ON</td></tr> </table>	CE	OUTPUT	L	OFF	H	ON
		CE	OUTPUT					
		L	OFF					
H	ON							
Connect CE pin with V _{DD} pin, when it is not used.								

■ WLCSP-5

Pin No.	Pin name	Functions						
1	CE	ON/OFF-Control pin						
		<table border="1"> <tr><td>CE</td><td>OUTPUT</td></tr> <tr><td>L</td><td>OFF</td></tr> <tr><td>H</td><td>ON</td></tr> </table>	CE	OUTPUT	L	OFF	H	ON
		CE	OUTPUT					
		L	OFF					
H	ON							
Connect CE pin with V _{DD} pin, when it is not used.								
2	GND	GND pin						
3	V _{OUT}	Regulator output pin						
4	V _{DD}	Voltage-supply pin						
5	NC							

Absolute Maximum Ratings (Ambient Temperature, Ta=25°C)

Item	Symbol	Ratings	Unit
Storage Temperature	T _{STG}	-55~+125	°C
Supply Voltage	V _{DD}	7	V
CE Input Voltage	V _{OUT}	-0.3~V _{DD} +0.3	V
Output Voltage	V _{OUT}	-0.3~V _{DD} +0.3	V
Output Current	I _{omax.}	200	mA
Power Dissipation	P _d	190	mW

Recommended Operating Conditions (Ambient Temperature, Ta=25°C)

Item	Symbol	Ratings	Unit
Operating Temperature	T _{op}	-40~85	°C
Operating Voltage	V _{OP}	2~6	V
Output Current	I _o	0~150	mA

Electrical Characteristics (V_{DD}=V_{OUT} typ.+1V, V_{CE}=V_{DD}, Ta=25°C unless otherwise specified)

Item	Symbol	Measurement conditions	Min.	Typ.	Max.	Unit
Input Current(OFF)	I _{DDoff}	V _{CE} =0V		0.1	1.0	μA
No-Load Input Current	I _{DD}			45	100	μA
Output Voltage	V _{OUT}	1mA ≤ I _{OUT} ≤ 30mA	×0.98		×1.02	V
Line Regulation	V _{LINE}	V _{DD} =V _o typ.+0.5~6V I _{OUT} =30mA		0.05	0.20	%/V
Load Regulation	V _{LOAD}	1mA ≤ I _{OUT} ≤ 80mA		20	45	mV
Dropout Voltage	V _{io}	Please refer to another page				V
Ripple Rejection *1	RR	Please refer to another page				dB
V _{OUT} Temperature Coefficient *1	Δ V _{OUT} /ΔT	I _{OUT} =10mA -40mA ≤ T _{OPT} ≤ 85°C		±100		ppm/°C
Output Short-Circuit Current *1	I _{lim}	V _o =0V		30		mA
CE Pull-down Resistance	R _{pd}		2.5	5	15	MΩ
CE High Threshold voltage	V _{CEH}		1.5		V _{DD}	V
CE Low Threshold voltage	V _{CEL}		0		0.25	V

Note: *1 design guaranteed.

Electrical Characteristics 2 ($V_{DD}=V_{OUT}$ typ.+1V, $V_{CE}=V_{DD}$ $T_a=25^\circ\text{C}$ unless otherwise specified)

Product Name	PARAMETER									
	Output Voltage			Dropout Voltage			Ripple Regulation*1			
	V_{OUT} (V)			V_{io} (V)			RR (db)			
	TEST CONDISIONS	MIN.	TYP.	MAX.	TEST CONDISIONS	TYP.	MAX.	TEST CONDISIONS	TYP.	MAX.
MM3091J	1mA ≤ I _{OUT} ≤ 30mA	1.764	1.800	1.836	*2			f=1kHz V _{ripple} = 0.5V	80	
MM3091K		1.862	1.900	1.938						
MM3092A		1.960	2.000	2.040	I _{OUT} =100mA	0.25	0.35			
MM3092B		2.058	2.100	2.142	2.0 ≤ V _{OUT} ≤					
MM3092C		2.156	2.200	2.244	2.3					
MM3092D		2.254	2.300	2.346	2.4 ≤ V _{OUT} ≤	0.24	0.29			
MM3092E		2.352	2.400	2.448						
MM3092F		2.450	2.500	2.550	2.8 ≤ V _{OUT} ≤	0.23	0.26			
MM3092G		2.548	2.600	2.652						
MM3092H		2.646	2.700	2.754						
MM3092J		2.744	2.800	2.856						
MM3092K		2.842	2.900	2.958						
MM3093A		2.940	3.000	3.060						
MM3093B		3.038	3.100	3.162						
MM3093C		3.136	3.200	3.264						
MM3093D		3.234	3.300	3.366						
MM3093E		3.332	3.400	3.468						
MM3093F		3.430	3.500	3.570						
MM3093G		3.528	3.600	3.672						
MM3093H		3.626	3.700	3.774						
MM3093J		3.724	3.800	3.876						
MM3093K		3.822	3.900	3.978						
MM3094A		3.920	4.000	4.080	5.0					
MM3094B		4.018	4.100	4.182						
MM3094C		4.116	4.200	4.284						
MM3094D		4.214	4.300	4.386						
MM3094E		4.312	4.400	4.488						
MM3094F		4.410	4.500	4.590						
MM3094G		4.508	4.600	4.692						
MM3094H		4.606	4.700	4.794						
MM3094J	4.704	4.800	4.896							
MM3094K	4.802	4.900	4.998							
MM3095A	4.900	5.000	5.100	4.1 ≤ V _{OUT} ≤	70					
				5.0						

Note: *1 design guaranteed.

Note: *2 The parameter is not guaranteed in the model less than $V_{OUT}=2V$.

Characteristics (2.8V product Except where noted therwise, $T_a=25^\circ\text{C}$, $V_{IN}=V_O+1\text{V}$, $V_{CE}=V_{DD}$, $C_{IN}=2.2\mu\text{F}$, $C_O=2.2\mu\text{F}$)

Output Voltage

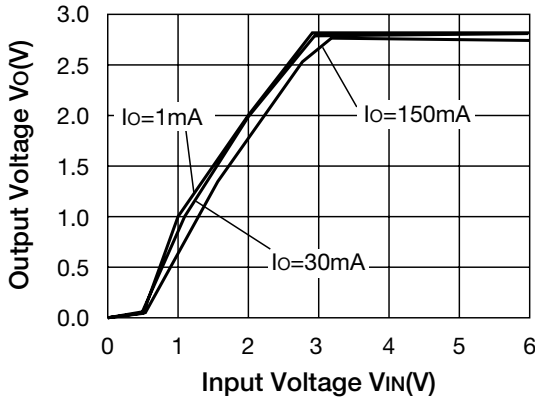

No-Load Input Current

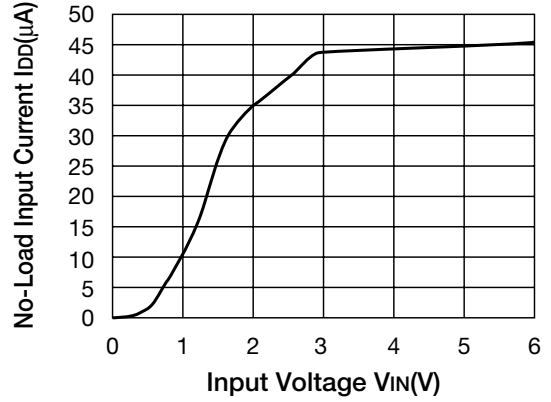

Line Regulation

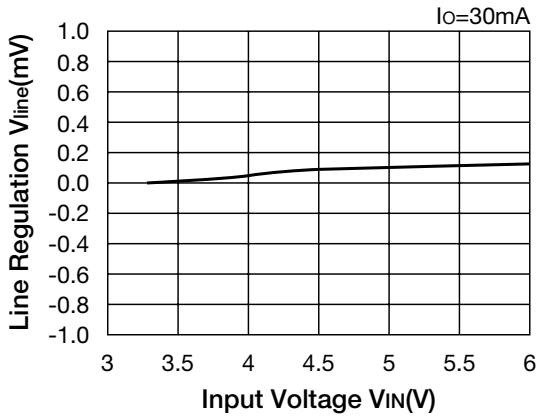

Load Regulation

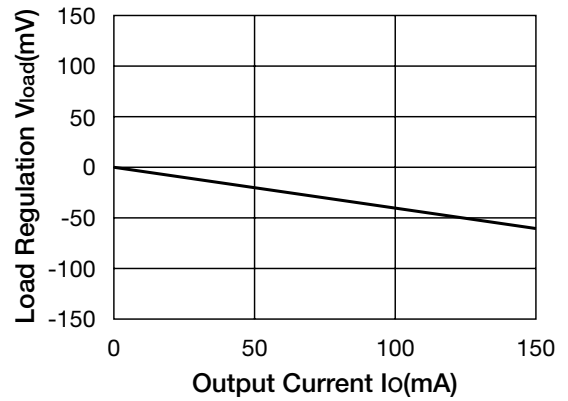

Dropout Voltage

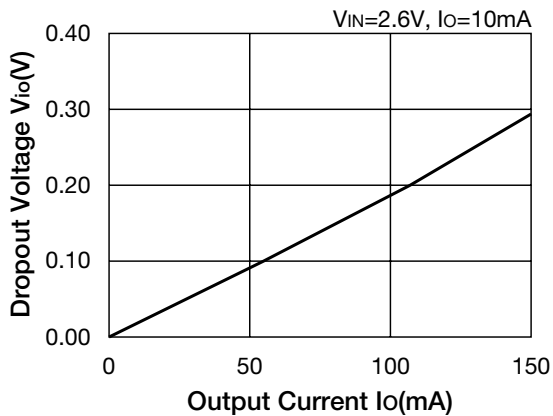

Current Limit

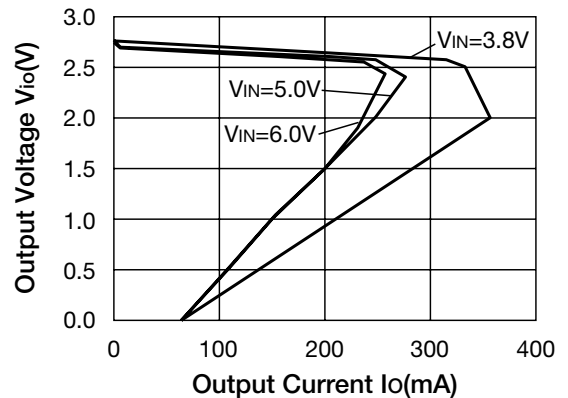

Characteristics (2.8V product Except where noted therwise, $T_a=25^\circ\text{C}$, $V_{IN}=V_O+1\text{V}$, $V_{CE}=V_{DD}$, $C_{IN}=2.2\mu\text{F}$, $C_O=2.2\mu\text{F}$)

GND Pin Current

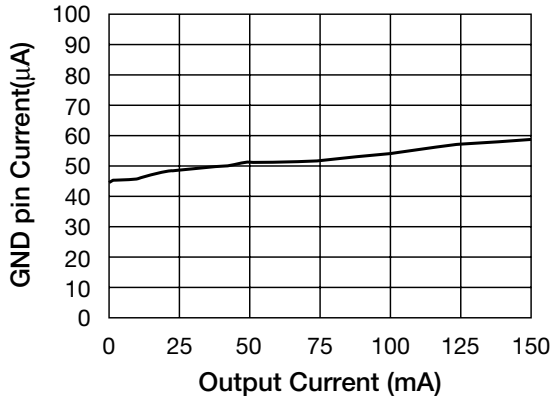

ESR

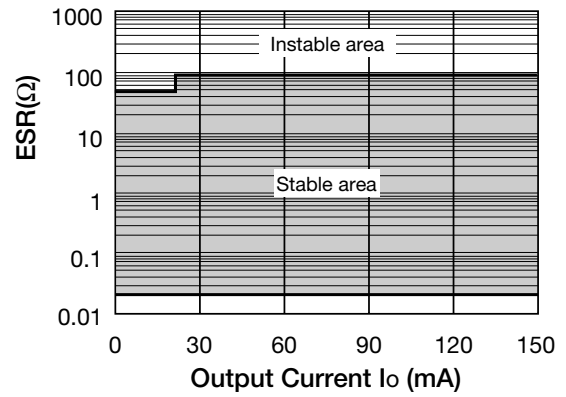

Output Voltage-Ambient Temperature

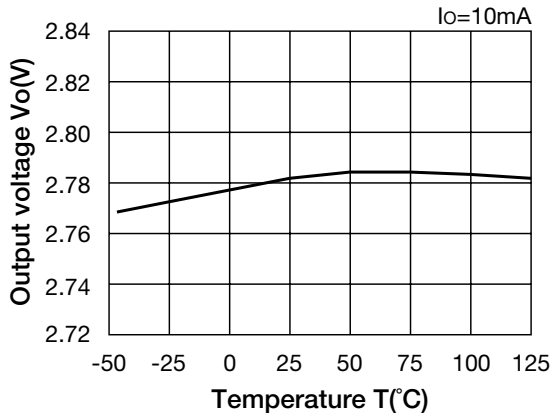

Ripple Rejection

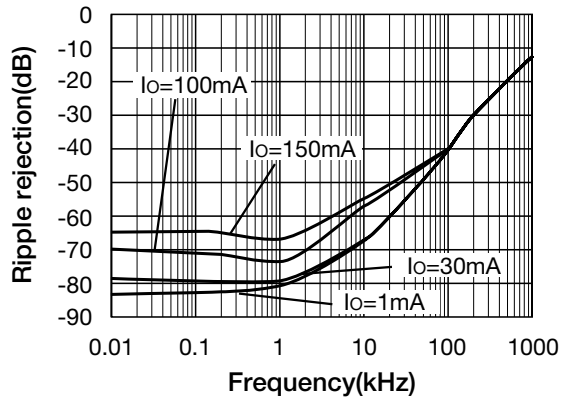

Characteristics (2.8V product Except where noted therwise, $T_a=25^{\circ}\text{C}$, $V_{IN}=V_O+1\text{V}$, $V_{CE}=V_{DD}$, $C_{IN}=2.2\mu\text{F}$, $C_O=2.2\mu\text{F}$)

Rise Time ($V_{CE}=0 \rightarrow 2.0\text{V}$)

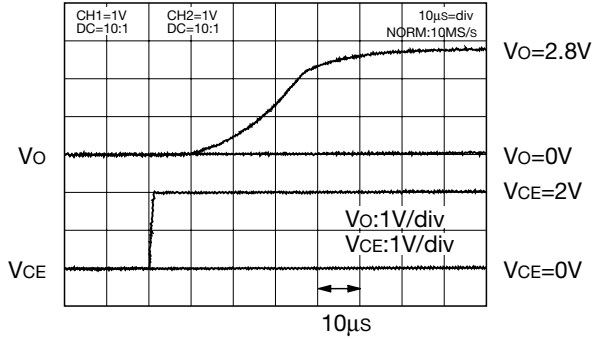

Input Transient Response ($V_{DD}=3.8\text{V} \rightarrow 4.8\text{V}$)

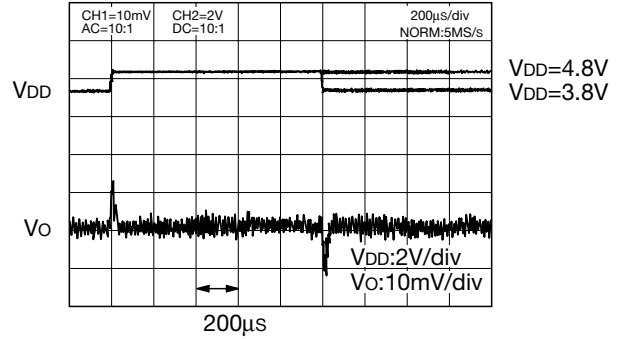

Load Transient Response ($V_O=1\text{mA} \rightarrow 100\text{mA}$, $C_O=2.2\mu\text{F}$)

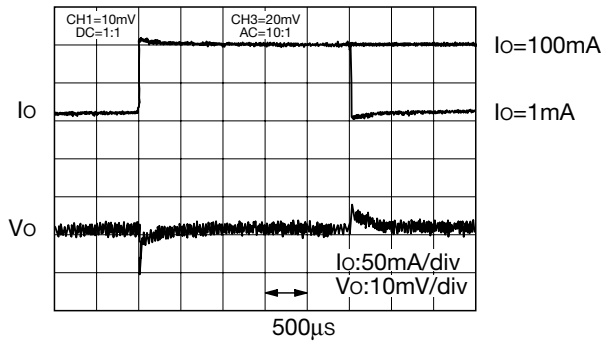

Load Transient Response ($V_O=1\text{mA} \rightarrow 100\text{mA}$, $C_O=1.0\mu\text{F}$)

