

**Precision, Low-Noise  
JFET Instrumentation Amplifiers**

**FEATURES**

- Ultra Low Noise:
  - 1.65nV/Hz Voltage Noise
  - 4fA/Hz Current Noise
- Sub-Audio 1/f Noise Corner
- Fixed Gain:
  - 30dB (MN2310)
  - 40dB (MN2311)
  - 50dB (MN2312)
- Gain Accuracy  $\pm 0.25$ dB
- Wide Power Supply Range
  - +/-8V to +/-15V
- 1MHz Input Bandwidth
- True Differential Inputs 600MW Impedance
- Over Voltage Protected
- Small 44-pin CLCC (JEDEC "C")
- 0°C to +70°C, -55°C to +125°C Operation
- Optional Environmental Stress Screening

**DESCRIPTION**

The MN2310 Series exceptionally low noise characteristics and low input bias current is made possible with the use of a large-area discrete JFET differential input stage. These selected and matched JFETs exhibit superior noise characteristics to those available in monolithic JFET instrumentation amplifiers.

The JFET input stage is combined with low-noise opamps to provide an exceptional bandwidth composite amplifier with low distortion characteristics.

Precision laser-trimmed resistors facilitate high gain accuracy without the use of external resistors. Internal compensation provides maximum flat gain to 1MHz.

One user-selected external capacitor is required to precisely set the 6dB/octave low-frequency gain roll-off, a feature often desired in AC amplifiers.

The devices are available in factory-set fixed gains of 30dB, 40dB, and 50dB (MN2310, MN2311, and MN2312, respectively) and are packaged in small 44-pin ceramic leadless chip carriers (CLCCs). Commercial devices are specified for 0°C to +70°C operation while "H" models are specified for -55°C to +125°C operation. "H/B" models are available with environmental stress screening.

Applications for the MN2310 Series include SONAR systems and other piezoelectric transducer-based systems (hydrophones, seismometers, accelerometers, condenser microphones) as well as CT scanners, Ultrasound, high energy physics instrumentation and other instrumentation.



**Absolute Maximum Ratings**

Operating Temperature Range	-55°C to +125°C
Specified Temperature Range	
MN231X	0°C to +70°C
MN231XH, H/B, H/B CH	-55°C to +125°C
Storage Temperature Range	-65°C to +150°C
Supply Voltage	+/-15V
Analog Input Voltage	1V rms

**Ordering Information**

<b>Part Number</b>	<b>MN2310 H/B</b>
Select desired gain. MN2310 for 30dB, MN2311 for 40dB and MN2312 for 50dB.	
Select temperature range. Standard device is specified for 0°C to +70°C operation. Add "H" for -55°C to +125°C operation.	
Add "B" suffix for environmental stress screening to "H" models.	

**SPECIFICATIONS**

Specifications @  $T_A=+25^\circ\text{C}$ , Supply Voltages +/-12V, unless otherwise indicated

Parameter	Condition	MIN	TYP	MAX	UNITS
Fixed Gain:					
MN2310	Single Ended Output		30		dB
MN2311			40		dB
MN2312			50		dB
MN2310	Balanced Output		36		dB
MN2311			46		dB
MN2312			56		dB
Gain Error @ +25°C	$V_o = \text{Pin 24 to GND}$		+/-0.1	+/-0.25	dB
Gain Tempco	$V_o = \text{Pin 24 to GND}$			+/-0.001	dB/°C
<b>Input Characteristics</b>					
Bias Current			4		pA
Impedance, Differential			600/12		MΩ/pF
Impedance, Common Mode			150/48		MΩ/pF
Overload Protection	100 μsec Current Pulse			0.5	A
Voltage Noise	@ 10kHz		1.65	2	nV/√Hz
Current Noise	@ 10kHz		4	20	fA/√Hz
<b>Output Characteristics</b>					
Voltage Swing:					
Single Ended	$R_L = 2k\Omega, \text{THD} = -60\text{dB}$		2.25		V rms
Balanced	$R_L = 2k\Omega, \text{THD} = -60\text{dB}$		4.50		V rms
Short Circuit Current	Pin 23, Pin 24		34		mA
Capacitive Load Stability	Pin 23, Pin 24		200		pF
Total Harmonic Distortion	$R_L = 2k\Omega, V_o = 2V \text{ rms}$		-90		dB
Offset @ Pin 24	Unity D.C. Gain	25	50		mV
Small Signal Bandwidth	$V_o = -12\text{dB}$		1		MHz
Slew Rate			3.5		V/μsec
<b>Power Supply Requirements</b>					
Power Supply Range		+/-8	+/-12	+/-15	Volts
Current Drains:					
+ $V_{CC}$			+12	+14	mA
- $V_{CC}$			-12	-14	mA

Specifications subject to change without notification as Micro Networks reserves the right to make improvements and changes in its products.

**Pin Designations**

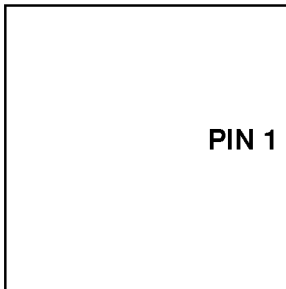

1. Cext/RAgain	12. NC	23. Voltage Out (+)	34. NC
2. Cext	13. NC	24. Voltage Out (-)	35. NC
3. Ground	14. -V Bypass	25. +V Supply	36. R9 Gain
4. NC	15. NC	26. NC	37. NC
5. NC	16. NC	27. +V Bypass	38. NC
6. NC	17. NC	28. NC	39. NC
7. NC	18. -V Bypass	29. NC	40. Input (+)
8. NC	19. NC	30. NC	41. Input (-)
9. NC	20. -V Supply	31. NC	42. NC
10. NC	21. NC	32. NC	43. Shield (Lid)
11. NC	22. NC	33. NC	44. Shield (Sub.)

**Input Protection** - Protecting the input stage of a low noise amplifier from destructive input transients is a complex problem. Normal diodes and MOV's present loading problems when placed across the input terminals. Biased diodes (diodes connected from the input leads to V+ and V- in a reversed condition) contribute to input noise current. Input series resistors used in a series current limiting circuit seriously add to the noise voltage (En) of most low noise amplifiers.

The MN2310 Series Low Noise Amplifiers contain a unique input protection circuit which has been carefully designed to protect the amplifier without causing unwanted noise performance deterioration. Standard product devices are protected from

current pulses of up to 2A-seconds from kilovolt transients (open circuit).

**1/f noise for low audio and subaudio applications** - Highly sensitive instruments, such as seismographs and radiation detectors use the low audio and sub-audio frequency bands. In these applications, amplifiers are required to have exceptionally low 1/f noise characteristics. Unfortunately, all semiconductors exhibit some degree of 1/f noise depending on the type of semiconductor device and process. 1/f noise is typically quantified by identifying the break frequency f/1 where the noise density has risen 3dB above the mid band value.

**Block Diagram**

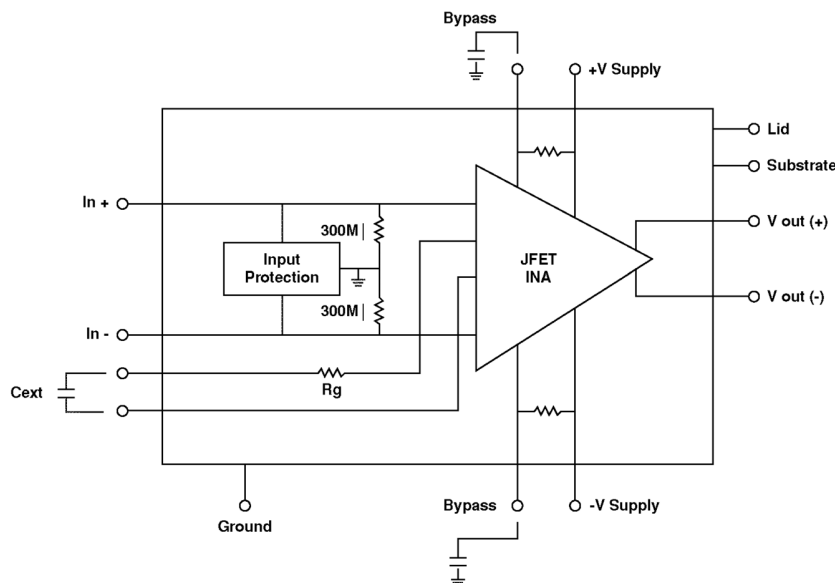

The n-type JFET front end in the MN2310 Series Low Noise Instrumentation Amplifiers produces exceptionally low 1/f noise. A typical noise density of the En parameter of the MN2310 is shown below.

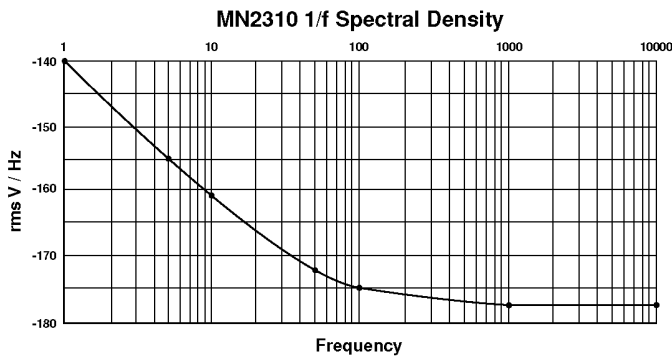

**High CMR Amplifier** - The MN2310 Series is shown below connected as a high-CMR ac amplifier. The ac configuration uses a single bypass capacitor (Cext) to set the low frequency 3dB rolloff point. The low frequency roll-off as a function of the value of Cext is given below and depicted in the following figure.

$$F_{3dB} = 1/2\pi RC \text{ where } R = 46 \text{ k}\Omega$$

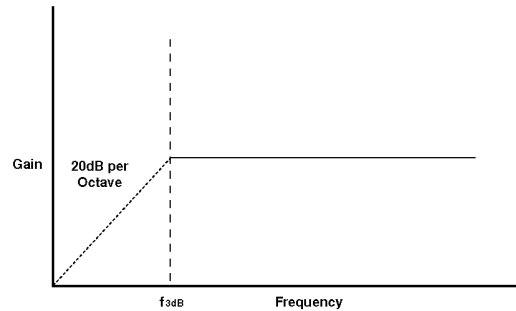
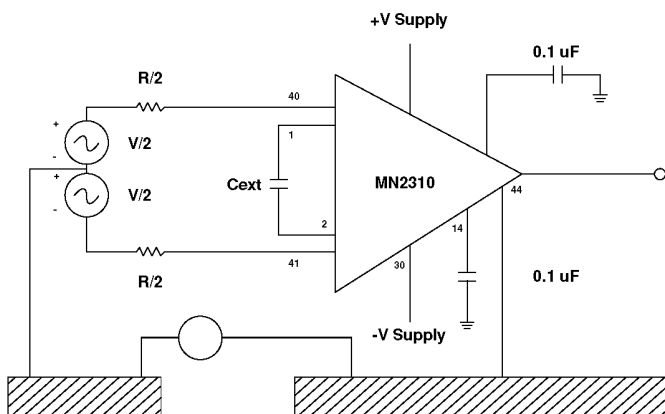

**Adjusting Device Gain** - The gain of the MN2310 Series Amplifiers is predetermined by three resistors, two of which are laser trimmed thin film resistor networks. However, access to the gain setting resistors (R7 and R9) for the MN2310 Series is provided for user-defined gains via external resistors. Resistors R7 and R9 are internal to the MN2310 Series amplifiers and have values as follows:

Device	Fixed Gain	R7(kΩ)	R9(Ω)
MN2310	30dB	1.42	46
MN2311	40dB	4.59	46
MN2312	50dB	14.50	46

**Gain Formula**

Gain (dB) = 20 Log (R7 Req + 0.5)  
 where Req = R9 // Rext for an increase in gain or  
 where Req = R9 + Rext to decrease gain.

**Performance Curves**

**Frequency Response**

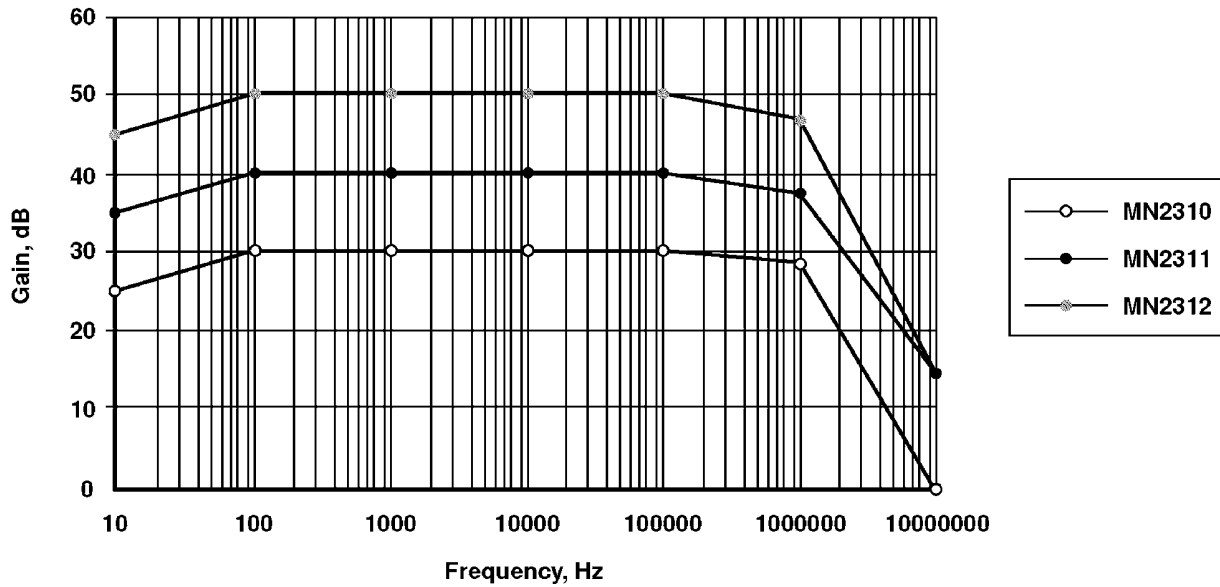

**Total Harmonic Distortion, MN2311**

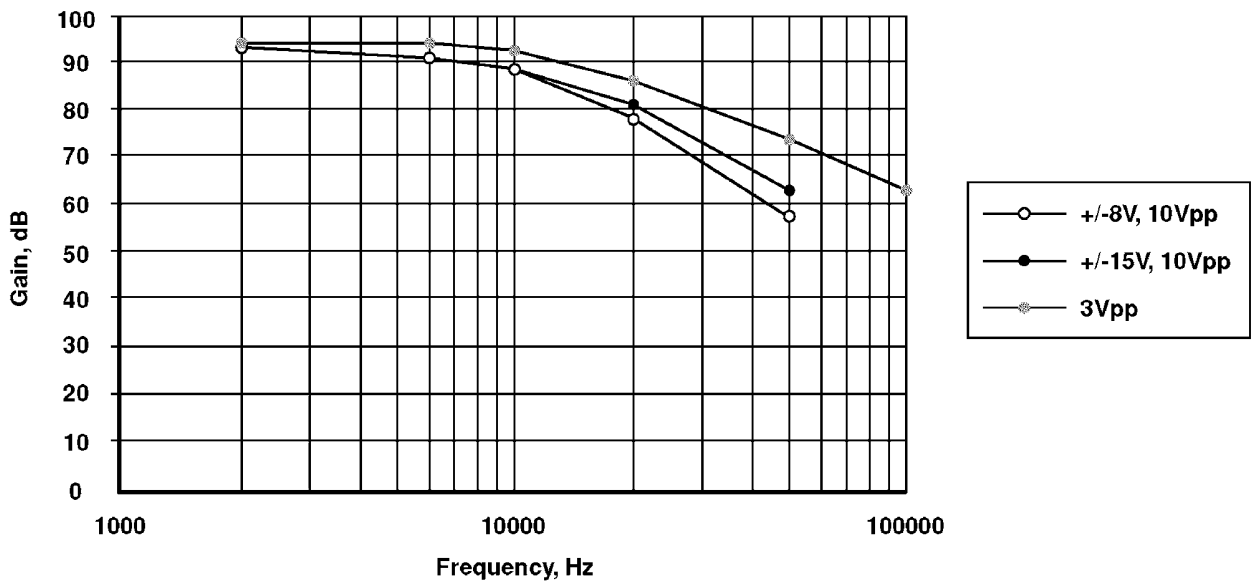



### Performance Curves

MN2310 Series CMR

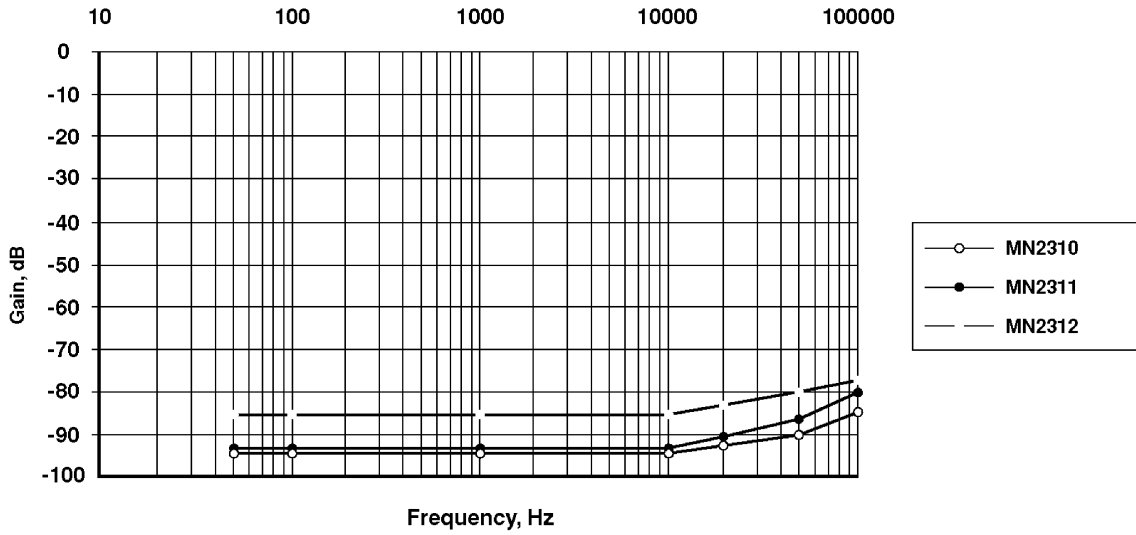

MN2310 Series Supply Rejection

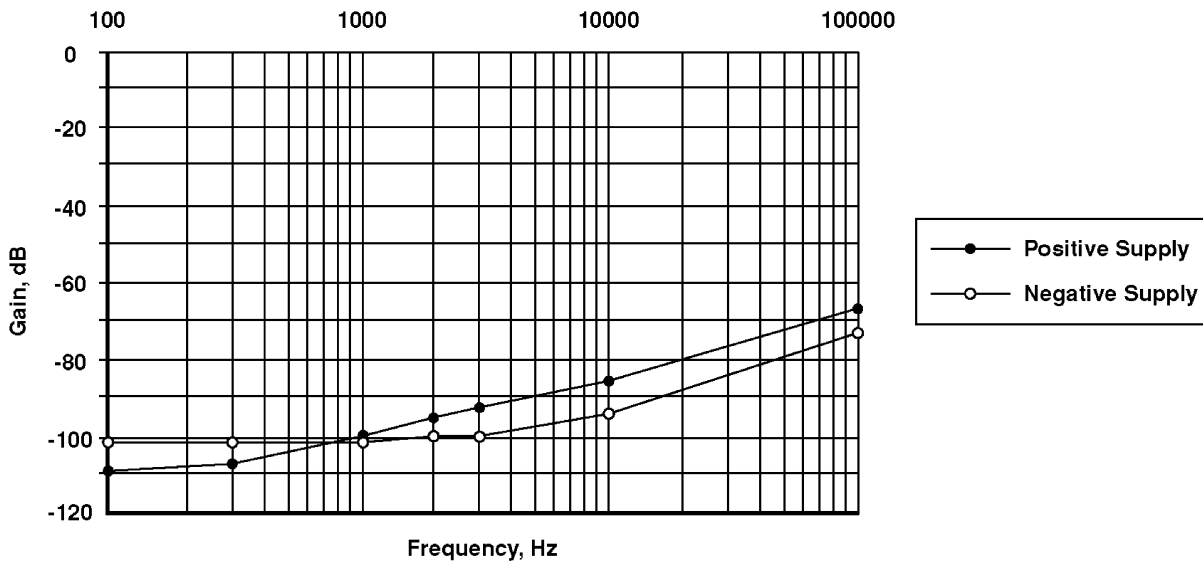

**PERFORMANCE CURVES**

**Noise as a Function of Frequency**

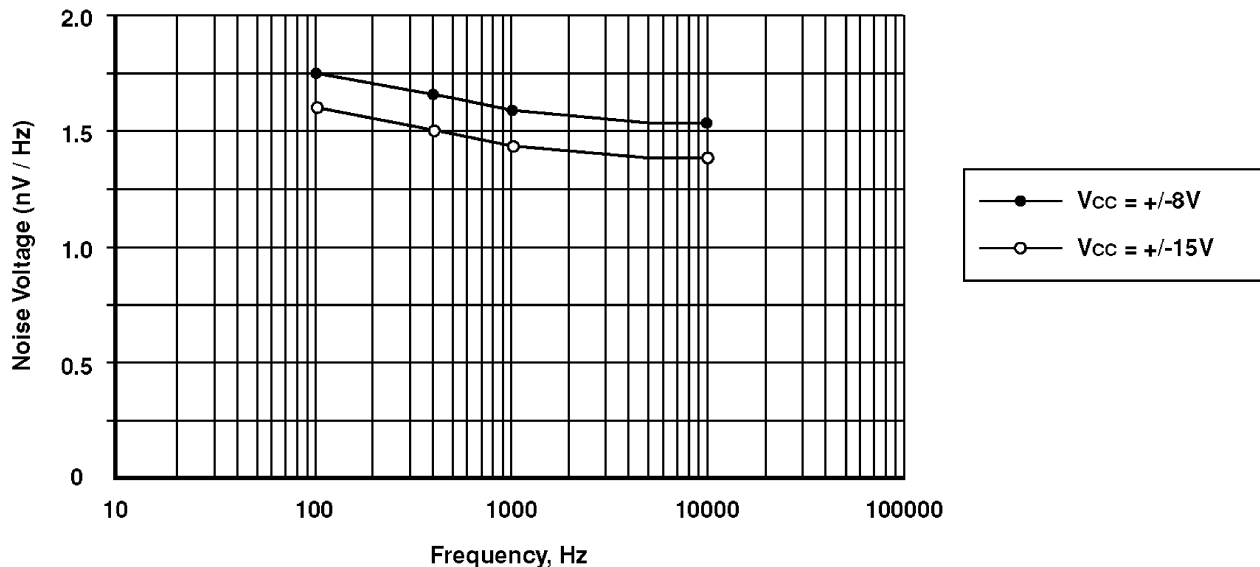

**PACKAGE OUTLINE**

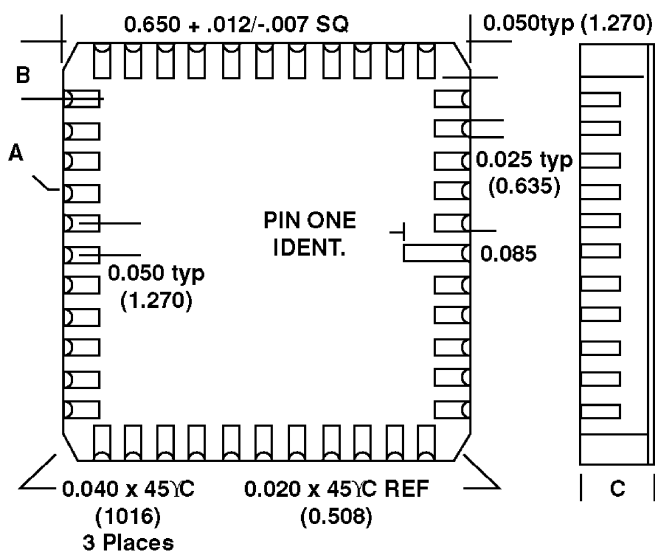

- A 0.008 R typ; (0.203)
- B 0.075 +/-0.010; (1.905+/-0.254)
- C 0.141 max; (3.581)

Dimensions in Inches (MM)