

### Features

- Single power can operate at 3.0V or 4.5V (LCD dependent)
- 3 1/2 digits LCD display with 5 information flags, in 1/2 duty 1/2 bias.  
They are colon, PM, CHM, ALM, AL.
- 4 operation modes and easily operating :  
Regular mode, current time adjust mode, Alarm time adjust mode, Chime on/off & alarm on/off mode.
- The voice content is stored up to 14.5 seconds at 6 KHz (15400h) and can be separated up to 64 sections.
- The length of each section can be different and is multiples of 100h.
- The length of a section with mute could be up to 8000h.
- Report current time by each TALK key trigger, except in Alarm mode.
- Current time display at regular mode.
- Set alarm function on/off by setting ALM flag on/off.
- Report Alarm on/off status and display.
- Report Chime on/off status and display.
- Setting current time the display in flashing.
- Alarm time will report at every setting.
- Report Alarm sound with time when alarm time is due.
- Setting alarm time in hour and minute.
- PM flag displayed at 12 HR format after 12:00.
- 12/24 HR format selectable by pressing HOUR key when in regular mode.
- Two independent chime sentence groups for 12 & 24 HR chime modes. A group has 24 chime sentences for 24 HR chime mode. The other group has 12 sentences.
- Based on the 32768 Hz quartz crystal.
- Current output can drive 8 ohm speaker with a transistor. Vout can drive buzzer directly.
- Hour and minute digit adjustable individually by pressing HR and MN key and can be repeat in fast mode.
- Time rolling reading in 1 Hz flash on two colon dots.
- Automatic ramp up and ramp down.
- Power on reset automatically.
- Automatic power down.
- Reset to regular mode when in other mode without any key input for 20 - 40 seconds.
- Voice output frequency can be tuned by external resistor.
- Mosel standard codes are available.
- MSM9203 demo board (COB) is provided.

### General Description

The Mosel SW003 is a monolithic CMOS LSI intelligent chip that is dedicated for clock/watch application with time announcing & alarm warning. 10 sentences are built-in for report and adjusting time and alarm. 3 1/2 digits LCD with 3 information flags are interfaced. With Mosel Editing system, every human language can be defined by user when manufacturing.

Pages 9, 10, 11, 14 through 17 are provided herein. Pages 1 through 8 and 12, 13 are provided by file in DOS format per request.

Taiwan  
#1, Creation Road I,  
Science - based Industrial Park,  
Hsinchu, 30077  
Taiwan, ROC  
"taylor\_hsiao@ccmail.mosel.com.tw"  
TEL: 886-3-5770055  
FAX: 886-3-5772788  
FAX: 886-3-5784732

Taipei  
7F, #102 Sec. 3,  
Ming Chung E. Road,  
Taipei, 105  
Taiwan, ROC  
TEL: 886-2-5451213  
FAX: 886-2-5451214





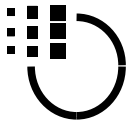

Hongkong  
#19 Dai Fu Street,  
Taipo Industrial Estate,  
Taipo, N.T.  
Hongkong  
TEL: 852-2388-8277(MKO)  
TEL: 852-2665-4883  
FAX: 852-2664-2406  
FAX: 852-2770-8011(MKO)

U.S.A.  
#3910 North First Street,  
San Jose,  
CA. 65134-1501  
U.S.A.  
TEL: 1-408-433-6000  
FAX: 1-408-433-0952



### COB Informations

#### Legend

-  Copper pad for X'tal
-  Copper pad for LCD
-  Copper pad for LCD
-  Through hole
-  Alignment hole
-  Standing hole

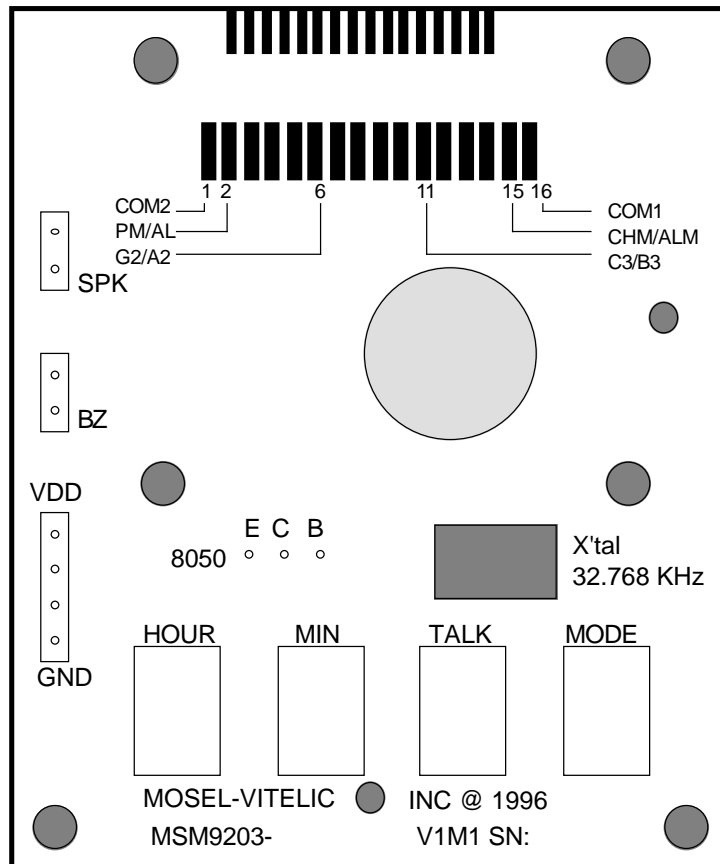
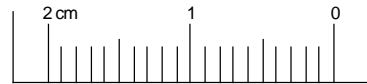

Specifications subject to change without notice, contact your sales representatives for the most recent information.

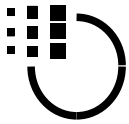

### Timing Diagrams

#### I. Mode key operation, selecting modes

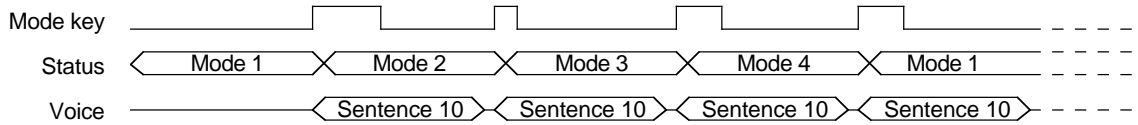

#### II.a. Talk key in mode 1,2,4

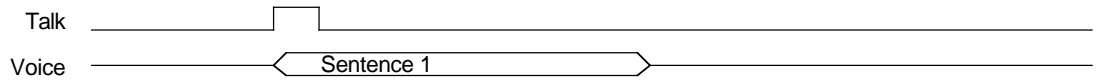

#### II.b. Several Talk keys in mode 1,2,4

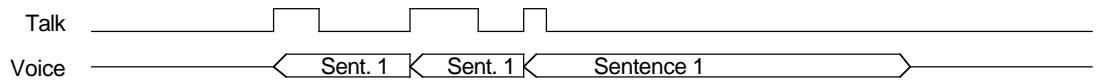

#### II.c. Long Talk key in mode 1,2,4

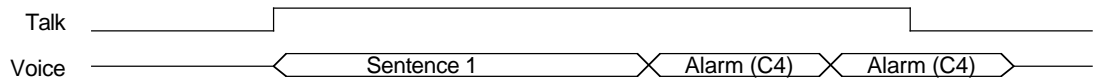

#### II.d. Talk key in mode 3

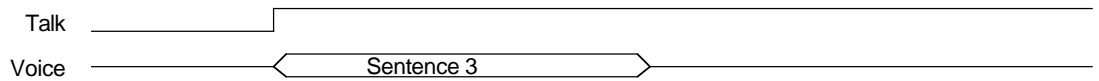

#### III.a. HR key in mode 1

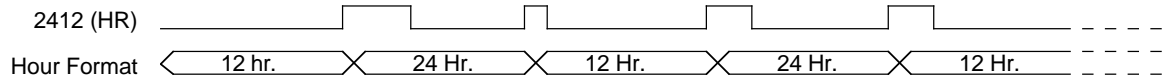

#### III.b. HR key in mode 2,3

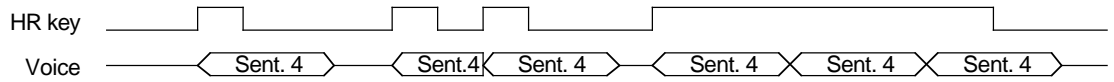

#### III.c. HR key in mode 4 (initial state is OFF)

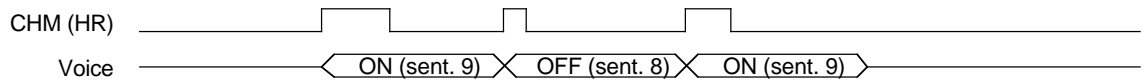

#### IV.a. MN Key in mode 2,3

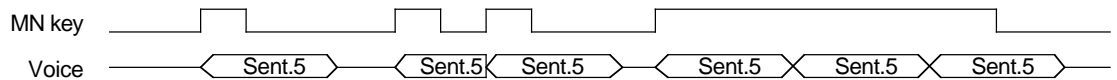

#### IV.b. MN key in mode 4 (initial state is OFF)

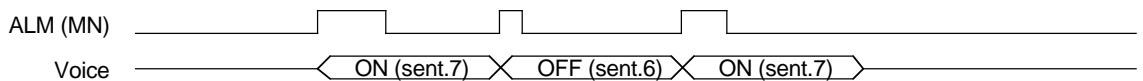

#### V.a. Talk at Alarm : (condition : Alarm time = 11:30, Alarm ON, Chime ON or OFF)

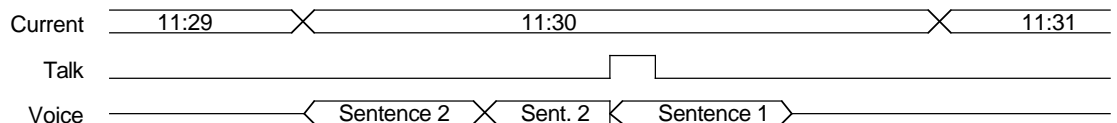

Specifications subject to change without notice, contact your sales representatives for the most recent information.

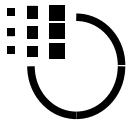

**V.b. Alarm function (conditions as V.a.)**

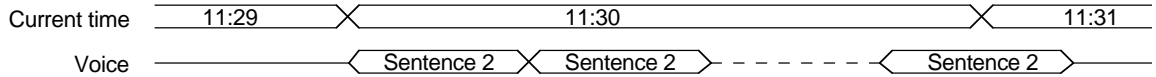

**V.c. Key (mode or HR or MN) at Alarm (conditions as V.a.)**

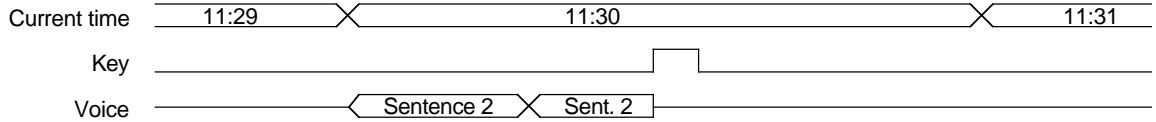

**VI.a. Chime function : (conditions : Alarm OFF, Chime ON)**

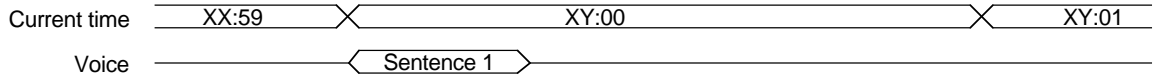

**VI.b. Talk at Chime (conditions as VI.a)**

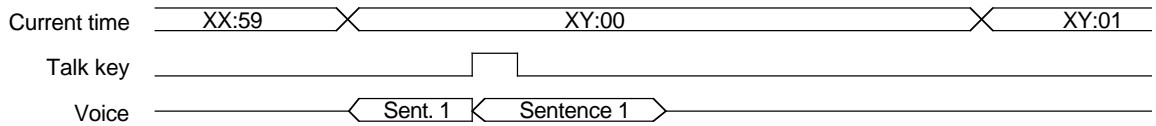

**VI.c. Key (Mode or HR or MN) at Chime (conditions as VI.a)**

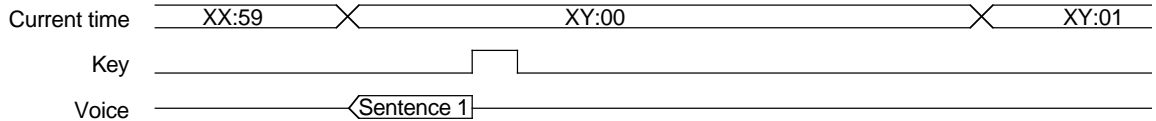

**Application Circuits**

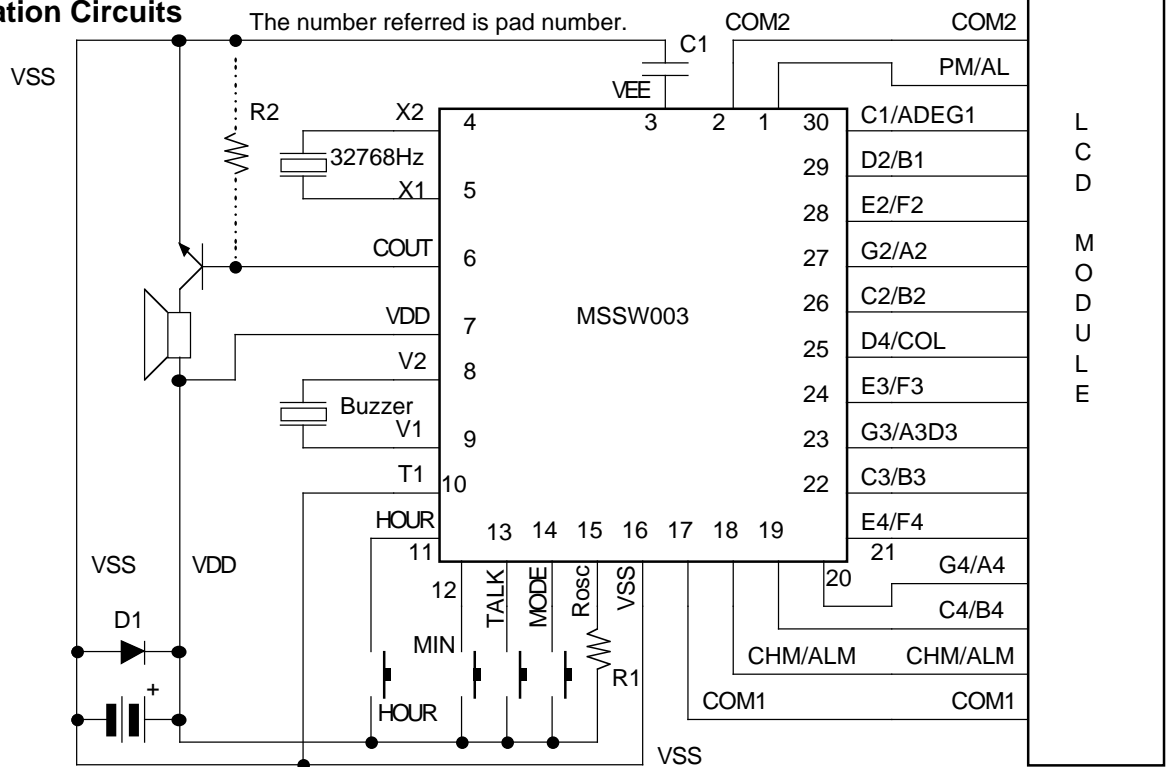

Specifications subject to change without notice, contact your sales representatives for the most recent information.

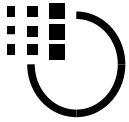

TITLE

Product Request Form A : Voice Word Definitions : There are  $1 \leq$    $\leq 64$  words defined.

Address	Voice Description	Voice Length	MuteLength	WordTotal ≤ 8000h					
00		S 00h	S 00h	00h	33		S	00h	S 00h 00h
01		S 00h	S 00h	00h	34		S	00h	S 00h 00h
02		S 00h	S 00h	00h	35		S	00h	S 00h 00h
03		S 00h	S 00h	00h	36		S	00h	S 00h 00h
04		S 00h	S 00h	00h	37		S	00h	S 00h 00h
05		S 00h	S 00h	00h	38		S	00h	S 00h 00h
06		S 00h	S 00h	00h	39		S	00h	S 00h 00h
07		S 00h	S 00h	00h	40		S	00h	S 00h 00h
08		S 00h	S 00h	00h	41		S	00h	S 00h 00h
09		S 00h	S 00h	00h	42		S	00h	S 00h 00h
10		S 00h	S 00h	00h	43		S	00h	S 00h 00h
11		S 00h	S 00h	00h	44		S	00h	S 00h 00h
12		S 00h	S 00h	00h	45		S	00h	S 00h 00h
13		S 00h	S 00h	00h	46		S	00h	S 00h 00h
14		S 00h	S 00h	00h	47		S	00h	S 00h 00h
15		S 00h	S 00h	00h	48		S	00h	S 00h 00h
16		S 00h	S 00h	00h	49		S	00h	S 00h 00h
17		S 00h	S 00h	00h	50		S	00h	S 00h 00h
18		S 00h	S 00h	00h	51		S	00h	S 00h 00h
19		S 00h	S 00h	00h	52		S	00h	S 00h 00h
20		S 00h	S 00h	00h	53		S	00h	S 00h 00h
21		S 00h	S 00h	00h	54		S	00h	S 00h 00h
22		S 00h	S 00h	00h	55		S	00h	S 00h 00h
23		S 00h	S 00h	00h	56		S	00h	S 00h 00h
24		S 00h	S 00h	00h	57		S	00h	S 00h 00h
25		S 00h	S 00h	00h	58		S	00h	S 00h 00h
26		S 00h	S 00h	00h	59		S	00h	S 00h 00h
27		S 00h	S 00h	00h	60		S	00h	S 00h 00h
28		S 00h	S 00h	00h	61		S	00h	S 00h 00h
29		S 00h	S 00h	00h	62		S	00h	S 00h 00h
30		S 00h	S 00h	00h	63		S	00h	S 00h 00h
31		S 00h	S 00h	00h	Length summ. of above 64 words <input type="text"/> 00h must be ≤ 15400h				
32		S 00h	S 00h	00h	Signature & date <input type="text"/>				
					MVI Sales & date <input type="text"/>				

Specifications is subject to change without notice, contact your sales representatives for the most recent information

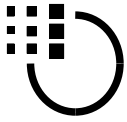

**TITLE**

**Product Request Form B : Minutes Reading Definitions Table**

Minute	List of Entries (addresses)	Entry Count
:00	<small>Note 1</small>	
:01		
:02		
:03		
:04		
:05		
:06		
:07		
:08		
:09		
:10		
:11		
:12		
:13		
:14		
:15		
:16		
:17		
:18		
:19		
:20		
:21		
:22		
:23		
:24		
:25		
:26		
:27		
:28		
:29		
:30		

:31		
:32		
:33		
:34		
:35		
:36		
:37		
:38		
:39		
:40		
:41		
:42		
:43		
:44		
:45		
:46		
:47		
:48		
:49		
:50		
:51		
:52		
:53		
:54		
:55		
:56		
:57		
:58		
:59		
:60( :00)		<small>Note 2</small>

Entry count summation of above 61 minutes =

Note 1. This minute reading is not read by sentence 5.  
Note 2. This minute reading is read only by sentence 5.

Signature & date	<input type="text"/>
MVI Sales & date	<input type="text"/>

Specifications is subject to change without notice, contact your sales representatives for the most recent information

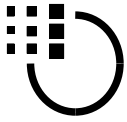

<b>TITLE</b>	
--------------	--

**Product Request Form C : Hour Reading Definitions**

24 Hour Format Definition Table		
Hour	List of Entries (addresses)	Entry Count
01:		
02:		
03:		
04:		
05:		
06:		
07:		
08:		
09:		
10:		
11:		
12:		
13:		
14:		
15:		
16:		
17:		
18:		
19:		
20:		
21:		
22:		
23:		
24:(00:)		
Entry count summation of above 24 hours =		

12 Hour Format Definition Table		
Hour	List of Entries (addresses)	Entry Count
01:(13:)		
02:(14:)		
03:(15:)		
04:(16:)		
05:(17:)		
06:(18:)		
07:(19:)		
08:(20:)		
09:(21:)		
10:(22:)		
11:(23:)		
12:(24:)(00:)		
Entry count summation of above 12 hours =		

Entry count summation of above 3 tables =   
 (must be ≤ 512)  
 These 3 tables are 24 hours,  
 12 hours and 61 minutes

Signature & date	
MVI Sales & date	

Specifications is subject to change without notice, contact your sales representatives for the most recent information

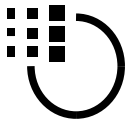

<b>TITLE</b>	
--------------	--

**Product Request Form D : Vocabulary & Sentence Definitions**

**Definitions of Vocabularies**

Vocabulary	Address or KeyWord	Vocabulary	Address or KeyWord	Vocabulary	Address or KeyWord
C0		C4.Sound		C10	
C1	Hour.Table	C5.RESET	Note	C11	
C2	Minute.Table	C6.RETURN	Note	C12	
C3.AM		C7		C13	
C3.PM		C8.CARRY	Note	C14	
		C9		C15	

Note. C5, C6, C8 all have to have length 800h or longer.

**Definitions of Sentences**

SentenceIndex	List of Vocabularies															
Sentence 1 Current Time	1	2	3	4	5	6	7	8	9	10	11	12	13	14	15	16
	C	C	C	C	C	C	C	C	C	C	C	C	C	C	C	C
Sentence 2 Alarm is due	1	2	3	4	5	6	7	8	9	10	11	12	13	14	15	16
	C	C	C	C	C	C	C	C	C	C	C	C	C	C	C	C
Sentence 3 Alarm time you set	1	2	3	4	5	6	7	8	9	10	11	12	13	14	15	16
	C	C	C	C	C	C	C	C	C	C	C	C	C	C	C	C
Sentence 4 Adjust hour	1	2	3	4	5	6	7	8	9	10	11	12	13	14	15	16
	C	C	C	C	C	C	C	C	C	C	C	C	C	C	C	C
Sentence 5 Adjust minute	1	2	3	4	5	6	7	8	9	10	11	12	13	14	15	16
	C	C	C	C	C	C	C	C	C	C	C	C	C	C	C	C
Sentence 6 Set alarm off	1	2	3	4	5	6	7	8	9	10	11	12	13	14	15	16
	C	C	C	C	C	C	C	C	C	C	C	C	C	C	C	C
Sentence 7 Set alarm on	1	2	3	4	5	6	7	8	9	10	11	12	13	14	15	16
	C	C	C	C	C	C	C	C	C	C	C	C	C	C	C	C
Sentence 8 Set chime off	1	2	3	4	5	6	7	8	9	10	11	12	13	14	15	16
	C	C	C	C	C	C	C	C	C	C	C	C	C	C	C	C
Sentence 9 Set chime on	1	2	3	4	5	6	7	8	9	10	11	12	13	14	15	16
	C	C	C	C	C	C	C	C	C	C	C	C	C	C	C	C
Sentence 10 Mode changed	1	2	3	4	5	6	7	8	9	10	11	12	13	14	15	16
	C	C	C	C	C	C	C	C	C	C	C	C	C	C	C	C

Signature & Date	
MVI Sales & Date	

Specifications is subject to change without notice, contact your sales representatives for the most recent information