

Ultra Fast Recovery Rectifier Diodes

... Designed for use in switching power supplies, inverters and as free wheeling diodes. These state-of-the-art devices have the following features:

- * High Surge Capacity
- * Low Power Loss, High efficiency
- * Glass Passivated chip junctions
- * 150 °C Operating Junction Temperature
- * Low Stored Charge Majority Carrier Conduction
- * Low Forward Voltage , High Current Capability
- * High-Switching Speed 50 & 75 Nanosecond Recovery Time
- * Plastic Material used Carries Underwriters Laboratory Flammability Classification 94V-O

**ULTRA FAST
RECTIFIERS**

**8 AMPERES
700 -- 1000 VOLTS**

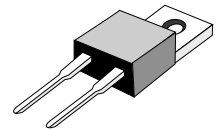

TO-220A

MAXIMUM RATINGS

Characteristic	Symbol	U08A				Unit
		70	80	90	100	
Peak Repetitive Reverse Voltage Working Peak Reverse Voltage DC Blocking Voltage	V_{RRM} V_{RWM} V_R	700	800	900	1000	V
RMS Reverse Voltage	$V_{R(RMS)}$	490	560	630	700	V
Average Rectifier Forward Current	$I_{F(AV)}$	8.0				A
Non-Repetitive Peak Surge Current (Surge applied at rate load conditions halfwave, single phase, 60Hz)	I_{FSM}	125				A
Operating and Storage Junction Temperature Range	T_J, T_{stg}	- 65 to + 150				°C

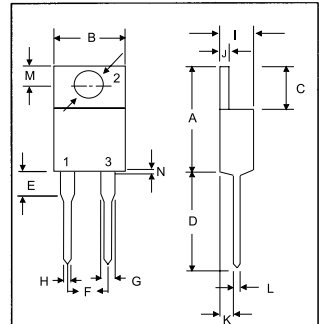

DIM	MILLIMETERS	
	MIN	MAX
A	14.68	15.32
B	9.78	10.42
C	6.01	6.52
D	13.06	14.62
E	3.57	4.07
F	4.83	5.33
G	1.12	1.36
H	0.72	0.96
I	4.22	4.98
J	1.14	1.36
K	2.20	2.97
L	0.33	0.55
M	2.48	2.98
N	--	1.00
O	3.70	3.90

ELECTRICAL CHARACTERISTICS

Characteristic	Symbol	U08A				Unit
		70	80	90	100	
Maximum Instantaneous Forward Voltage ($I_F=8.0$ Amp, $T_C=25$ °C) ($I_F=8.0$ Amp, $T_C=100$ °C)	V_F	1.75 1.65				V
Maximum Instantaneous Reverse Current (Rated DC Voltage, $T_C=25$ °C) (Rated DC Voltage, $T_C=100$ °C)	I_R	10 500				uA
Reverse Recovery Time ($I_F=0.5$ A, $I_R=1.0$ A, $I_{rr}=0.25$ A)	T_{rr}	50		75		ns
Typical Junction Capacitance (Reverse Voltage of 4 volts & f=1 MHz)	C_P	40				pF

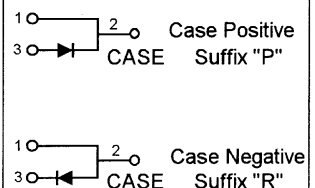

U08A70 Thru U08A100

FIG-1 TYPICAL FORWARD CHARACTERISTICS

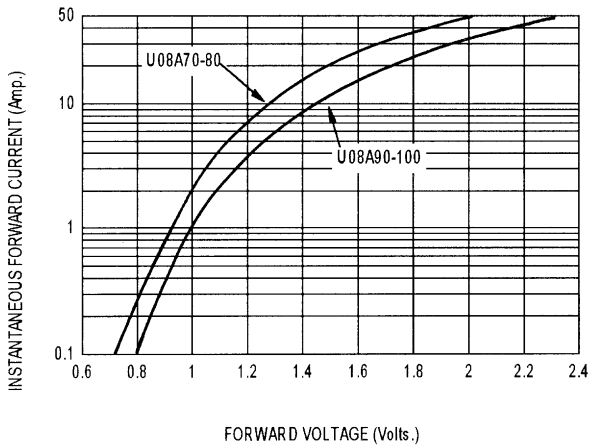

FIG-3 FORWARD CURRENT DERATING CURVE

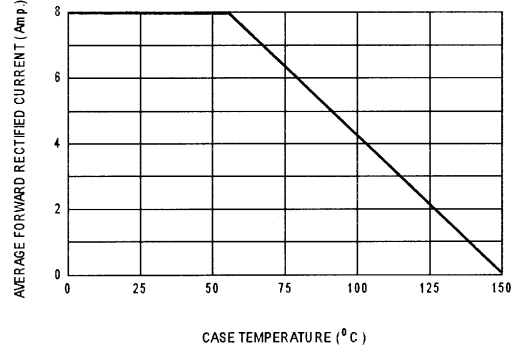

FIG-2 TYPICAL REVERSE CHARACTERISTICS

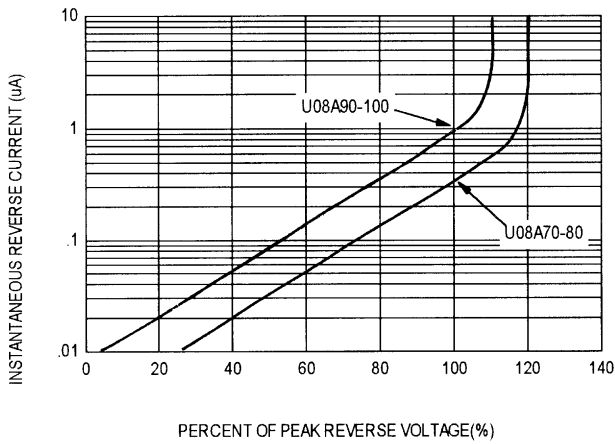

FIG-4 TYPICAL JUNCTION CAPACITANCE

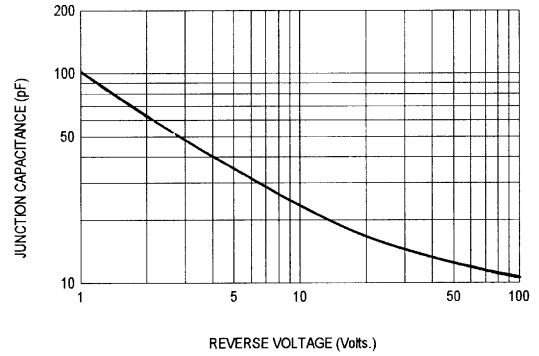
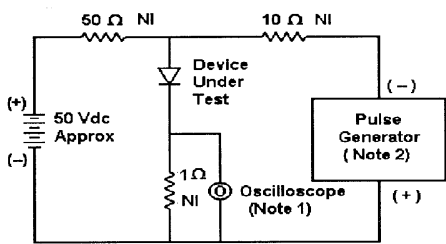
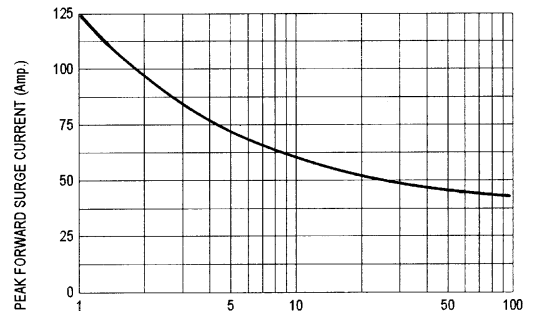

FIG-5 PEAK FORWARD SURGE CURRENT



- Notes:
 1. Rise Time = 7 ns max. Input Impedance = 1 M Ω, 22 pF
 2. Rise Time = 10 ns max. Input Impedance = 50 Ω

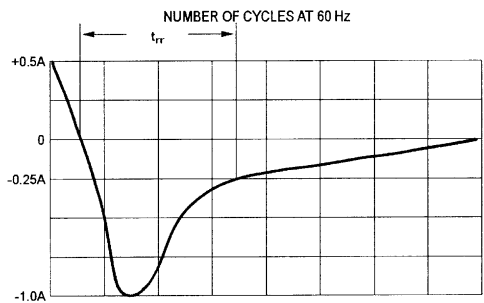

Fig-6 Reverse Recovery Time Characteristic and Test Circuit Diagram